

Modicon ASP890300 Remote I/O Processor Installation Guide

Version 1.0

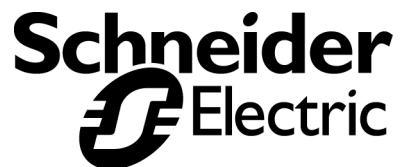

French, German, and Spanish Translations of Manual

French, German, and Spanish Translations of Manual

Modicon ASP890300 Remote I/O Processor Installation Guide, 31004128 01, Version 1.0 is available in printed hard copy in English only. It is also available in PDF format in French, German, and Spanish, and can be accessed through Schneider Electric's Web site.

The following instructions assume that you are using a Windows-based PC and a mouse with left and right buttons. Browser response should be similar whether you are using *Internet Explorer* or *Navigator*.

To access the Web site and view the *Installation Guide* in French, German, or Spanish, follow these steps.

1. Enter this URL into your browser:
<http://www.schneider-automation.com>
 2. When the home page appears, type the following term in the **Search** field:
"ASP890300"
 3. Execute the search.
 4. The *Installation Guide*'s link should display in the list that appears in the search results.
 5. Double click on the title/link.
A second window appears.
 6. In the **Attachment:** field of the second, smaller window, right-click on the appropriate language PDF:
 - **31004150_K01_000_00.pdf for French**
 - **31004151_K01_000_00.pdf for German**
 - **31004152_K01_000_00.pdf for Spanish**
 7. From the shortcut menu select **Save Target As...**
 8. Save the **.pdf** file to your desktop or a folder.
 9. The *Installation Guide* should open with *Adobe Acrobat Reader*.
-

Table of Contents



	Safety Information	7
	About the Book	9
Chapter 1	ASP890300 Installation Guide	11
	At a Glance	11
	ASP890300 General Description	12
	Indicators	15
	Power, Backplanes, I/O and Typical Configuration	16
	Switch Settings	19
	Diagnostics	24
	Installation	27
	Specifications	29
Appendices	33
	Title of Overview Map	33
Appendix A	ASP890300 Universal Hardware Upgrade Guide	35
	At a Glance	35
	Replacement of AS-P89X-000 Adapters	36
	Replacement of AS-J89X-X0X Adapters	37
	Replacement of AS-J81X-000 Adapters	39
	Replacement of Slot Mount PLCs	41
	Backplane Interconnection Diagrams	42
	ASP89X Capacity Information	44
	Power Supply Capacities in Remote Drop Secondary Applications	45
	I/O Module Current Requirements	46
Appendix B	ASP890300 Executive Software Reflash	49
	At a Glance	49
	Interconnection	50
	Communication Parameters	51
	Procedure	52

Appendix C	CE Requirements for ASP890300/800 Series I/O Systems	.. 53
	At a Glance	53
	Requirements	54
	Installation	55
	Parts List	56
Index57

Safety Information

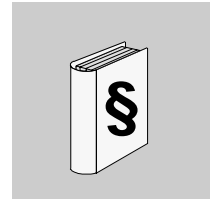

Important Information

NOTICE

Read these instructions carefully, and look at the equipment to become familiar with the device before trying to install, operate, or maintain it. The following special messages may appear throughout this documentation or on the equipment to warn of potential hazards or to call attention to information that clarifies or simplifies a procedure.



The addition of this symbol to a Danger or Warning safety label indicates that an electrical hazard exists, which will result in personal injury if the instructions are not followed.



This is the safety alert symbol. It is used to alert you to potential personal injury hazards. Obey all safety messages that follow this symbol to avoid possible injury or death.



DANGER

DANGER indicates an imminently hazardous situation, which, if not avoided, **will result** in death, serious injury, or equipment damage.



WARNING

WARNING indicates a potentially hazardous situation, which, if not avoided, **can result** in death, serious injury, or equipment damage.



CAUTION

CAUTION indicates a potentially hazardous situation, which, if not avoided, **can result** in injury or equipment damage.

PLEASE NOTE

Electrical equipment should be serviced only by qualified personnel. No responsibility is assumed by Schneider Electric for any consequences arising out of the use of this material. This document is not intended as an instruction manual for untrained persons.

© 2002 Schneider Electric All Rights Reserved

About the Book

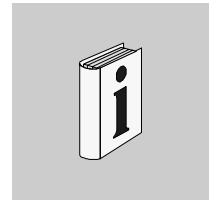

At a Glance

Document Scope The ASP890300 Remote I/O Processor overcomes component obsolescence issues affecting the existing Remote I/O processor models. This product insures continued availability of coaxial cable linked Remote I/O network offerings. Simultaneously, it maintains compatibility with its P890/P892 predecessors. Dual cable functionality and increased I/O power availability are added features. This manual provides specifications and operational information for the product. It also contains information about replacing equipment in earlier models.

Note: Equipment replacement guidelines, including those for J890/892, J810/812 and 984 slot-mounted controllers, are listed in Appendix A. Please review these guidelines before performing an upgrade.

Validity Note The data and illustrations found in this book are not binding. We reserve the right to modify our products in line with our policy of continuous product development. The information in this document is subject to change without notice and should not be construed as a commitment by Schneider Electric.

Product Related Warnings

Schneider Electric assumes no responsibility for any errors that may appear in this document. If you have any suggestions for improvements or amendments or have found errors in this publication, please notify us.

No part of this document may be reproduced in any form or by any means, electronic or mechanical, including photocopying, without express written permission of Schneider Electric.

All pertinent state, regional, and local safety regulations must be observed when installing and using this product. For reasons of safety and to assure compliance with documented system data, only the manufacturer should perform repairs to components.

When controllers are used for applications with technical safety requirements, please follow the relevant instructions.

Failure to use Schneider Electric software or approved software with our hardware products may result in injury, harm, or improper operating results.

Failure to observe this product related warning can result in injury or equipment damage.

User Comments

We welcome your comments about this document. You can reach us by e-mail at TECHCOMM@modicon.com

ASP890300 Installation Guide



At a Glance

Purpose

This guide describes the Modicon ASP890300 800 I/O Remote receiver with Power.

What's in this Chapter?

This chapter contains the following topics:

Topic	Page
ASP890300 General Description	12
Indicators	15
Power, Backplanes, I/O and Typical Configuration	16
Switch Settings	19
Diagnostics	24
Installation	27
Specifications	29

ASP890300 General Description

Overview

The MODICON ASP890300 800 I/O Remote I/O processor with Power provides an interface between PLCs and 800 Series Remote I/O modules. Two half-duplex ASCII ports are available.

The basic modes of operation are P890/P892/J890 replication (AS-P89X-000 and AS-J890-X0X) and J892 emulation (AS-J892-X0X).

The ASP890300 Processor is compatible with all Schneider Electric controllers that support the S908/CRP-type Remote I/O networks and all 800 Series I/O modules. Remote I/O communication is accomplished over single or dual coaxial cable networks. The number of drops and points supported depends on the system PLC. Operating modes are rotary switch-selectable, and include single or dual RI/O cable. These, in part, eliminate improper Comm Error LED indications when operating with a single cable connecting the drop.

Rotary switch selectable operating modes, plus two executive reflash options are:

- J890/P890 single or dual RI/O cable operation
- J892 and P892 single or dual RI/O cable operation
- RTU or ASCII reflash modes

Executive software stored in flash memory may be updated through ASCII Port 1.

ASP890300 Compatibility

Those replacing the P89X processors will find the ASP890300 both power and backplane compatible. Some connector rewiring will be required. J890 or J892 processor replacement will require a backplane replacement. Depending on the number of I/O modules in the drop, a replacement may also include an additional power supply and rewiring.

Note: Equipment replacement guidelines, including those for J810/J812 and 984 slot-mount controllers are described in Appendix A. Please review this material before performing an upgrade.

The ASP890300 Processor is mounted into primary 10-, 19- or 27-inch 800 Series I/O backplanes. These provide connectivity between the processor and I/O modules.

Power

The processor is self-powered from either 115/230VAC or 24VDC sources. These power sources are independently switched ON/OFF on the front panel. The 115V/230VAC inputs are jumper-selectable on the power connector. Up to 7A of combined +5.0VDC and +4.3VDC load current is supplied by the processor to I/O in the primary backplane. No other power supplies may be used to augment the ASP890300. Power for I/O modules in secondary backplanes can be provided by auxiliary supplies interconnected with appropriate cables (see *ASP890300 Universal Hardware Upgrade Guide, p. 35*).

Front, Bottom, and Left Side View

The ASP890300 is depicted below.

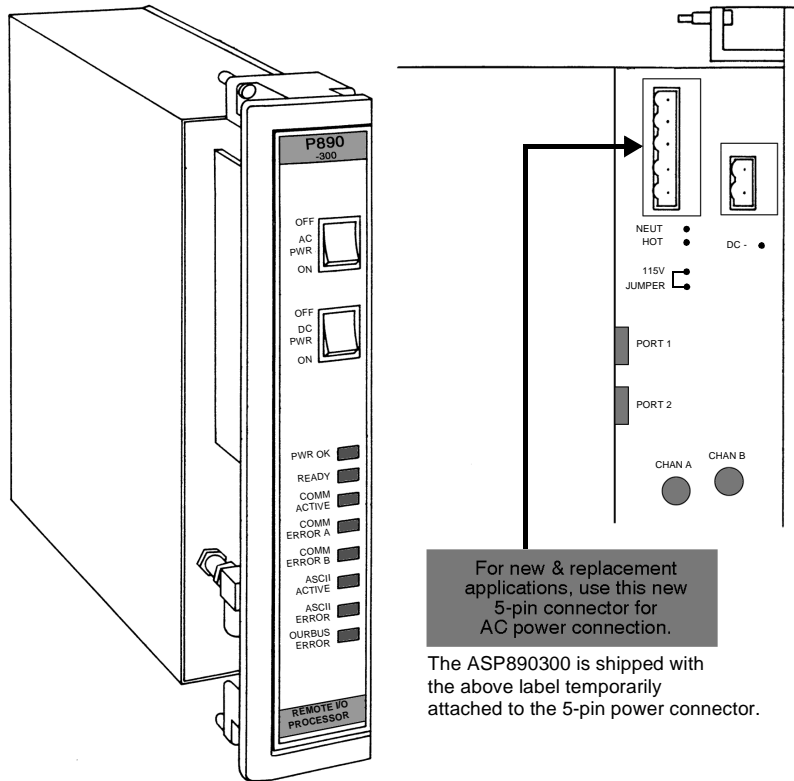

For new & replacement applications, use this new 5-pin connector for AC power connection.

The ASP890300 is shipped with the above label temporarily attached to the 5-pin power connector.

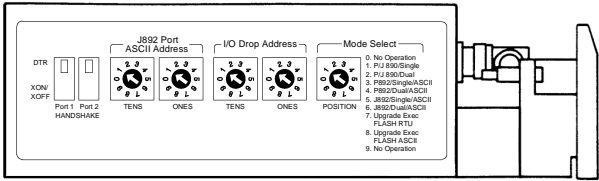

Right Side View and Label

The label is on the lower, right side. The label is upside-down. See *Switch Settings*, p. 19 for explanation of label terms.

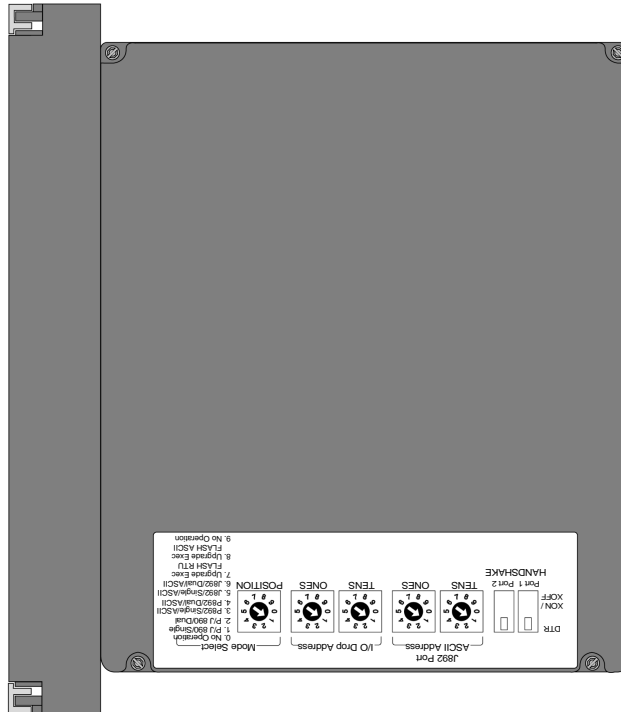

Indicators

LED Indicators

The following table describes the LED Indicators.

LED Nomenclature	Color	Function/Indication
PWR OK	Green	Power voltages are good and within specified specifications.
READY	Green	All internal diagnostics have completed successfully and the unit is available for normal operation.
COMM ACTIVE	Green	Unit is successfully and actively communicating on the remote I/O network.
COMM ERROR A	Red	Cable A is experiencing communications errors due to any of the following: <ul style="list-style-type: none"> ● broken cable ● poor or loose coaxial connection ● intermittent noise ● mode selector switch is in wrong position
COMM ERROR B	Red	Cable B is experiencing communications errors due to any of the following: <ul style="list-style-type: none"> ● broken or missing cable ● poor or loose coaxial connection ● intermittent noise ● mode selector switch is in wrong position
ASCII ACTIVE	Green	ASCII port is active.
ASCII ERROR	Red	Unit is experiencing errors with ASCII communication port.
OURBUS ERROR	Red	Unit is experiencing errors with a local I/O module, or: <ul style="list-style-type: none"> ● the entry in the traffic cop does not match the I/O module type; ● the I/O module is not present; or ● the I/O module is no longer operative.

Power, Backplanes, I/O and Typical Configuration

Power Supplied for I/O

The following table describes the power supplied for I/O use. The combination of the +5V and +4.3V loads shall not exceed 7.0A

Voltage	Current
+5.0VDC	7.0A
+4.3VDC	6.0A
-5.0VDC	0.5A

AC Power Input Connections

The following table describes the ASP890300 AC power connector.

Terminal	Nomenclature	Function
1	N	Neutral AC Line
2	L	Hot AC Line
3	G	Ground
4	Jumper inserted between 4 and 5 for 115V operation	
5		

	DANGER
	HAZARDOUS VOLTAGE <ul style="list-style-type: none"> • Disconnect all power before working on equipment. • Verify correct terminal connections when wiring. Failure to follow this precaution will result in death, serious injury, or equipment damage.

DC Power Input Connections

The following table describes the ASP890300 DC power connector.

Terminal	Nomenclature	Function
1	DC+	+24.0VDC
2	DC-	Common

Input Power Connectors Part Numbers

The following table lists part numbers for input power connectors.

Input	Part Number
AC	52-0378-000 (5-terminal)
DC	52-0380-000 (2-terminal)

Note: The ASP890300 is shipped with these connectors installed.

Compatible Backplanes

The following backplanes are compatible with the ASP890300.

Name	Description
AS-H810-208*	10", ASP890300 plus three I/O modules.
AS-H810-209*	10", ASP890300 plus three I/O modules.
AS-H819-209	19", ASP890300 plus six I/O modules.
AS-H827-209	27", ASP890300 plus ten I/O modules.
*Repair/service exchange only	

Typical Configuration

Here is a typical ASP890300 configuration.

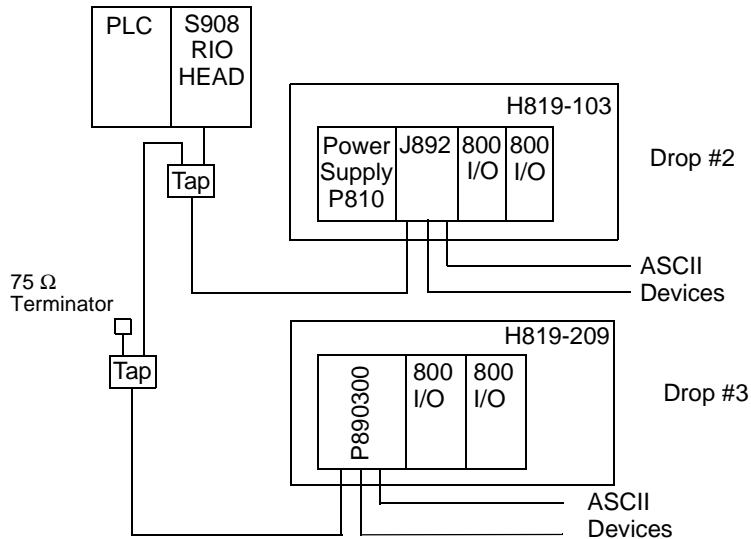

Remote I/O

The following table describes ASP890300 remote I/O.

Compatibility	All S908 Commands and Responses
Cable Medium	Coax, Single or Redundant Options
Termination	75Ω Internal
Shield Grounding Method	Capacitor Coupled to Chassis Ground
Device Address	1-32

Drop I/O Capacity

The following table describes ASP890300 drop I/O capacity.

Max Number of 800 Racks	5 Max: 1 Primary, 4 Secondary
Max Number of Inputs	1024 Points/64 Words
Max Number of Outputs	1024 Points/64 Words
Max I/O	2048 Points/128 Words
Drop Hold Up Time	300ms to 6553.6 seconds 10ms increments
Drop Scan Time	5ms for 256 I/O Points

ASCII Port Capacity

The following table describes ASP890300 ASCII port capacity.

Total Number ASCII Ports per Drop	2
Total Number ASCII Drops per System	16
Total Number ASCII Ports per System	32

Switch Settings

Switch Label

The following graphic shows the switch label.

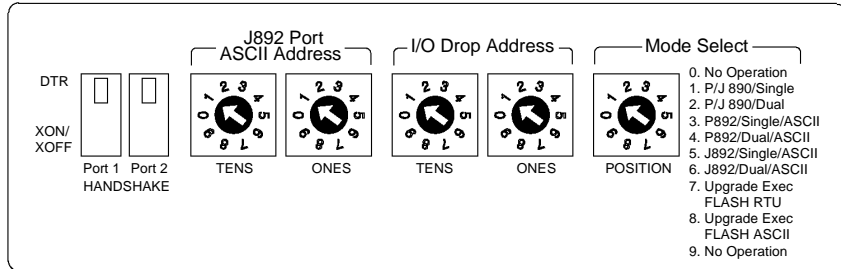

Mode Select Switch

The following table describes the ASP890300 mode select switch.

Rotary Switch Position	Label Nomenclature	Function
0	No Operation	Not Used
1	P/J 890/Single	P89x/J89x Single Cable/ASCII Disabled
2	P/J 890/Dual	P89x/J89x Dual Cable/ASCII Disabled
3	P892/Single/ASCII	P892 Single Cable/ASCII Enabled Port Address Switch Disabled
4	P892/Dual/ASCII	P892 Dual Cable/ASCII Enabled Port Address Switch Disabled
5	J892/Single/ASCII	J892 Single Cable/ASCII Enabled Port Address Switch Enabled
6	J892/Dual/ASCII	J892 Dual Cable/ASCII Enabled Port Address Switch Enabled
7	Upgrade Exec FLASH RTU	Flash Update via Port 1 using RTU Mode parameters Drop Functionally Disabled
8	Upgrade Exec FLASH ASCII	Flash Update via Port 1 using ASCII Mode parameters Drop Functionally Disabled
9	No Operation	Not Used

- Switch settings read only on power up
- Invalid switch position setting will be indicated by flashing Comm Error A and Comm Error B LEDs

I/O Drop Address Switches

The following table describes the ASP890300 drop address switches.

Switch Type	Function	Numbered	Valid Setting
10 Position Rotary	Ones	0 - 9	0 - 9
10 Position Rotary	Tens	0 - 9	0 - 3

- Switch settings read only on power up
- Drop address settings of 0 or greater than 32 are invalid addresses
- Invalid address setting will be indicated by flashing Comm Error A and Comm Error B LEDs

P892 (Mode 3/4) ASCII Port Addressing

The following table describes the ASP890300's P892 (Mode 3/4) ASCII port addressing determined by the I/O drop address switches.

Drop Address	ASCII Address	Drop Address	ASCII Address
1	1,2	9	17,18
2	3,4	10	19,20
3	5,6	11	21,22
4	7,8	12	23,24
5	9,10	13	25,26
6	11,12	14	27,28
7	13,14	15	29,30
8	15,16	16	31,32

- Switch settings read only on power up
- ASCII port rotary address switches disabled in this mode
- ASCII port addresses are related to the drop address and are based upon this table
- Drops 17 through 32 can still be used for 800 I/O, but cannot have associated ASCII ports

J892 Port ASCII Address Switches

The following table describes the ASP890300 ASCII port address switches.

Switch Type	Function	Numbered	Valid Setting
10 Position Rotary	Ones	0 - 9	0 - 9
10 Position Rotary	Tens	0 - 9	0 - 3

- Switch settings read only on power up
- Switch valid for Modes 5/6 only
- ASCII port address settings of 0 or greater than 31 are invalid addresses
- Invalid address setting will be indicated by flashing Comm Error A and Comm Error B LEDs

J892 (Mode 5/6) ASCII Port Addressing

The following table describes the ASP890300's J892 (Mode 5/6) ASCII port addressing determined by the J892 port ASCII address switches.

Switch Setting	ASCII Port Address	Switch Setting	ASCII Address
1 or 2	1, 2	17 or 18	17, 18
3 or 4	3, 4	19 or 20	19, 20
5 or 6	5, 6	21 or 22	21, 22
7 or 8	7, 8	23 or 24	23, 24
9 or 10	9, 10	25 or 26	25, 26
11 or 12	11, 12	27 or 28	27, 28
13 or 14	13, 14	29 or 30	29, 30
15 or 16	15, 16	31 or 32	31, 32

- Switch settings read only on power up
- ASCII port rotary address switches enabled in this mode
- ASCII port addresses of 0 and greater than 32 are invalid
- Invalid address setting will be indicated by flashing Comm Error A and Comm Error B LEDs

ASCII Port Handshake Switch

The following table describes the ASCII port handshake switch.

2 Position DIP Switch	Function
Port 1	Data Terminal Ready
	XON/XOFF
Port 2	Data Terminal Ready
	XON/XOFF

- Switch settings read only on power up

ASCII Port Interface Connector

The following table describes the ASCII port interface connector.

Female 9 Pin D-Type Pin Number	Signal Name	Description
1		Not Used
2	RXD	Receive Data
3	TXD	Transmit Data
4	DTR	Data Terminal Ready
5	SGND	Signal Ground
6	DSR	Data Set Ready
7	RTS	Request to Send
8	CTS	Clear to Send
9		Not Used

- D-sub shell tied to chassis ground.
-

ASCII Port Parameters

The following table describes programmable ASCII port parameters.

Port Address	1-32
Baud Rate	50, 75, 110, 134, 150, 300, 600, 1200, 1800, 2000, 2400, 3600, 4800, 7200, 9600, 19200
Data Bits	5, 6, 7, 8
Parity	None, Odd, Even
Stop Bits	1 or 2

ASCII Cable Distance

The maximum cable distance is 50 feet (15 meters).

Sample Pin Layout

The following figure describes one possible pin layout for a cable connecting a ASP890300 ASCII port and another device using hardwired flow control. Actual pin numbers may vary between remote devices.

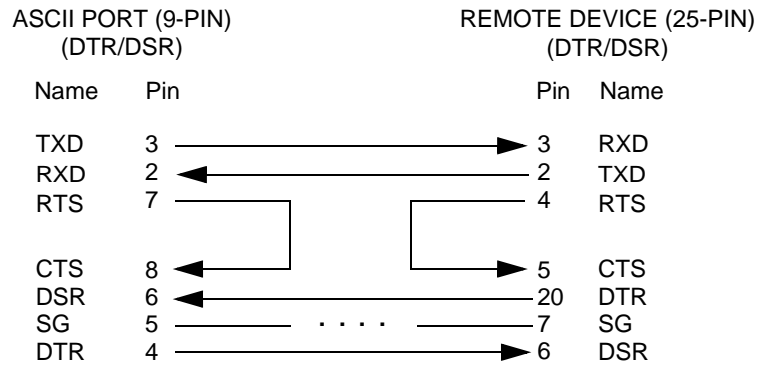

Diagnostics

Overview

The ASP890300 performs two classes of confidence tests, power-up tests and run-time tests. The power-up tests are designed to detect problems within the board hardware before lighting the ready LED and going on-line to receive and hand off data. The run-time tests attempt to catch board hardware problems while the ASP890300 is handling data and will force the unit to go off line if errors are detected. Errors always cause the ASP890300 to flash appropriate LEDs and to turn off the ready LED. The only way of returning to normal operation from a fatal error is to power cycle the unit.

Confidence Tests

The following table describes actions performed by ASP890300 confidence tests.

Confidence Test	Action Performed
Flash Checksum	Performs a checksum of the executive flash
RAM Data Test	Verifies RAM data integrity
RAM Address Test	Verifies RAM address integrity
LAN Controller	Verifies LAN controller integrity
OBM Test	Verifies OURBUS integrity

Flashing LED Error Codes

The following table describes the ASP890300 flashing LED codes.

Comm Active Flashes	Error Condition
0	Power Down Interrupt
1	Kernel Mode
2	Not Used
3	OBM Error
4	Bad/Unexpected Interrupt
	LAN Chip Error
	Receive Abort Error
	Transmission Loop Time-out
	Transmission DMA Time-out
	Cable A Initialization Error
	Cable A DMA Xfer Error
	Cable B DMA Xfer Error
	Cable A Dump Data Error
	Cable A DMA Hung
	Cable B DMA Hung
	Cable A/B DRQ Hung
	Power Up LAN Error
	Cable B Initialization Error
5	RAM Address Error
6	RAM Data Error
7	Exec Checksum Error
8	Kernel Detected Error
*	*Invalid Switch Setting

*Comm A/B Error LEDs flash together indicating an invalid switch setting.
Examples: Invalid Loop Address, Invalid ASCII Port Address, Invalid Mode Setting.

If an ASP890300 Remote I/O Processor exhibits any of the above flashing LED codes, follow the steps below.

If . . .	Then . . .
an ASP890300 Remote I/O Processor stops operating and exhibits any of the flashing LED codes in the previous table,	cycle the processor power off and back on when it is safe to do so.
Comm Active is flashing in any of the following patterns: <ul style="list-style-type: none">● one blink● seven blinks, or● eight blinks,	power cycle as above, then reflash the executive software (see <i>ASP890300 Executive Software Reflash</i> , p. 49).
neither of the above two actions restore normal operation,	replace the processor.

Installation

Overview

The following procedure describes how to install an ASP890300 Processor. The processor is installed in an H810-208, H810-209, or H819/H827-209 800 Series I/O Housing in the left-most slot.

Panel Software Requirements

The ASP890300 is a direct replacement for the ASP89X-000 processor. If you need to reconfigure a program, you may use any panel software that supports P89X processors. Select the P89X when traffic copping (I/O mapping).

**Installing a
ASP890300
Processor**

Use the following procedure to install an ASP890300 Processor.

Step	Action
1	Set the processor's Mode Select and Drop Address switches appropriately (shown in <i>Switch Settings, p. 19</i>). <ul style="list-style-type: none"> For example, when replacing or emulating an AS-P890-000, AS-J890-001, or AS-J890-101, select Rotary Switch Position 1.
2	If using ASCII communications, set the processor's Port Address and Handshake switches as required. <ul style="list-style-type: none"> The Port 1/Port 2 Handshake and J892 Port ASCII Address switches are ignored if the Mode switch setting indicates ASCII is disabled. The Handshake switches are enabled if a switch position indicating ASCII Enabled is selected. The J892 Port ASCII switches are enabled as indicated.

	DANGER
	<p>HAZARDOUS VOLTAGE</p> <ul style="list-style-type: none"> Disconnect all power before working on equipment. Verify correct terminal connections when wiring. <p>Failure to follow this precaution will result in death, serious injury, or equipment damage.</p>

Step	Action
3	Ensure the processor power source is switched off. Connect power wires to the appropriate AC or DC power connector terminals. If using AC power, for 115VAC operation, insert a jumper between terminals 4 and 5.
4	Connect the Remote I/O coaxial cables. Plug the power connectors into the processor. NOTE: Due to space restrictions (especially if the backplane is rack-mounted), drop cables must be RG-6 maximum. If using dual cables, the suggested method for cable connection is to attach the CHAN A cable first, then the CHAN B. When disconnecting, reverse the process, and remove the CHAN B cable first.
5	Insert the processor into the leftmost slot of the backplane. Press firmly to ensure it is properly seated in the backplane.
6	Tighten the captive screws at the top and bottom of the processor.
7	If used, plug the ASCII connectors into the processor.
8	For AC application, switch on "AC Pwr" For DC application, switch on "DC Pwr"
9	Apply power when the system is ready for processor operation. Make sure that the PWR OK and RDY LEDs are ON . If the system PLC is in RUN mode, make sure that the COMM ACTIVE LED is ON and the OURBUS ERROR LED is OFF .

Specifications

ASP890300 Specifications

The following table describes the specifications of the ASP890300.

Remote I/O Cabling	Coaxial cable 75 ohm
Remote I/O Connector	F-Type
Remote I/O Communications Rate	1.544 MHz
I/O scan time	Less than 5ms for 256 I/O points
RIO comm link time	Less than 1ms for 256 I/O points
Drop hold up time	Programmable from 300ms to 6553.6 sec (in 100ms increments)
Power supplied to I/O (Short circuit proof)	+5VIO, 7A max* +4.3V, 6A max* -5V, 0.5A max *The +5VIO and +4.3V combined cannot exceed 7A.
Power Requirements	115VAC, 1.1A, 50/60Hz 230VAC, 0.65A, 50/60Hz 24VDC, 4A
Inrush Current	30A @ 115VAC 25A @ 24VDC
Power Loss Hold up time	1 cycle AC loss 1ms @ 24VDC

Power Supply

The following table describes ASP890300 power supply testing. (These requirements do not apply to the DC auxiliary input.)

Test	Reference	Spec. Limit
Isolation AC Line to Output		2500 VDC 1780VAC
Electro-Static Discharge	IEC 1000-4-2	4KV Conducted 8KV Air Gap
Radio Frequency Interference	IEC 1000-4-3	10V/m 27MHz-1GHz
Fast Transient	IEC 1000-4-4	2.0KV Comm mode 2.0KV Diff mode
Surge Withstand	IEC1000-4-5	2.0KV Comm Mode 1.0KV Diff Mode
Conducted RF Susceptibility	IEC1000-4-6	0.15KHz-80MHz 10Vrms
Damped Oscillatory Wave	IEEE472	2.5KV Diff Mode 2.5KV Comm Mode

RIO Interface

The following table describes ASP890300 RIO interface testing.

Test	Reference	Spec. Limit
Isolation Coax to Backplane		500 VDC
Electro-Static Discharge	IEC 1000-4-2	4KV Conducted 8KV Air Gap
Radio Frequency Interference	IEC 1000-4-3	10V/m 27MHz-1GHz
Fast Transient	IEC 1000-4-4	1.0KV Cap Clamp
Surge Withstand	IEC1000-4-5	2.0KV to Shield
Conducted RF Susceptibility	IEC1000-4-6	0.15KHz-80MHz 10Vrms
Damped Oscillatory Wave	IEEE472	2.5KV to Shield

ASCII Ports

The following table describes ASP890300 ASCII ports testing.

Test	Reference	Spec. Limit
Isolation		No Test
Electro-Static Discharge	IEC 1000-4-2	4KV Conducted 8KV Air Gap
Radio Frequency Interference	IEC 1000-4-3	10V/m 27MHz-1GHz
Fast Transient	IEC 1000-4-4	1.0KV Cap Clamp
Surge	IEC1000-4-5	2.0KV to Shield
Conducted RF Susceptibility	IEC1000-4-6	0.15KHz-80MHz 10Vrms
Damped Oscillatory Wave	IEEE472	No Test <30 meters

Electromagnetic Emissions

The following table describes ASP890300 electromagnetic emissions testing.

Test	Reference	Spec. Limit
Radiated Emission	EN 55011	30-230MHz in situ at 10M 40dbuV 230-1000MHz in situ at 10M 47dbuV
Conducted Emission	EN55011	0.15-.5MHz 70(66) quasi peak (avg.) dbuV 0.5MHz-30MHz 73(60) quasi peak (avg.) dbuV

- Requires external filter

Temperature/ Vibration

The following table describes ASP890300 temperature and vibration testing.

Parameter	Reference	Specification Limits
Storage Temperature	IEC 68-2-14	-40 to +85°C
Operating Temperature	IEC 68-2-14	0 to 60°C Ambient
Humidity Non-Operating	IEC 68-2-3	95% RH at 60°C non-condensing
Humidity Operating	IEC 68-2-3	95% RH at 60°C non-condensing
Altitude	MIL-STD-810	15,000 feet
Vibration Operating	IEC-68-2-6	10-57Hz: 0.075mm Dual Axis
Shock Operating 3 shocks/axis	IEC 68-2-27	15g, 11ms
Free Fall Unpackaged	IEC 68-2-32	1m

Agency Approvals

The following table describes ASP890300 agency approvals.

Agency
UL 508
CSA 22.2-142
CE

Appendices

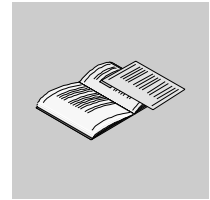

What's in this Appendix?

The appendix contains the following chapters:

Chapter	Chapter Name	Page
A	ASP890300 Universal Hardware Upgrade Guide	35
B	ASP890300 Executive Software Reflash	49
C	CE Requirements for ASP890300/800 Series I/O Systems	53

ASP890300 Universal Hardware Upgrade Guide



At a Glance

Purpose

The purpose of this chapter is to assist users in the physical replacement of existing 800 I/O Remote Adapters with the Schneider Electric ASP890300 Remote I/O Processor.

Existing Remote I/O system installations may utilize obsolete taps (MA-0185-000, Revision B or lower). The minimum revision taps that should be used are Revision C or higher. Any revision MA-0185-100 tap may be used. Refer to Section 3.6 of the *Modicon Remote I/O Cable System Planning and Installation Guide* (890 USE 101 00) for more information.

What's in this Chapter?

This chapter contains the following topics:

Topic	Page
Replacement of AS-P89X-000 Adapters	36
Replacement of AS-J89X-X0X Adapters	37
Replacement of AS-J81X-000 Adapters	39
Replacement of Slot Mount PLCs	41
Backplane Interconnection Diagrams	42
ASP89X Capacity Information	44
Power Supply Capacities in Remote Drop Secondary Applications	45
I/O Module Current Requirements	46

Replacement of AS-P89X-000 Adapters

Overview

The ASP890300 is backplane compatible with AS-P890-000 and AS-P892-000 installations. The AC power and ASCII port connections are different.

AC Power Connector Rewiring

Rewiring is required to accommodate a 5 terminal connector that includes a 115/230VAC jumper selection option as opposed to the switch selectable option in the original units. Rewiring requires a small slotted screwdriver.

	DANGER
	HAZARDOUS VOLTAGE <ul style="list-style-type: none">• Disconnect all power before working on equipment.• Verify correct terminal connections when wiring. Failure to follow this precaution will result in death, serious injury, or equipment damage.

ASCII Port Connector

Pin 1 on the P892 is chassis ground. Pin 1 on the ASP890300 ASCII port connector is not used. The connector shell is chassis ground.

Replacement of AS-J89X-X0X Adapters

Overview

The ASP890300 is **not physically compatible** if installations use the following adapter models.

AS-J890-001	AS-J892-001
AS-J890-002	AS-J892-002
AS-J890-101	AS-J892-101
AS-J890-102	AS-J892-102

In these installations, you will need to:

- replace the primary backplanes (housings)
- perform power calculations to determine if additional supplies are needed (see *I/O Module Current Requirements*, p. 46)
- consider backplane interconnection cables
- review ASCII port and coaxial cable connection

Primary Backplane Replacement

ASP890300 modules are compatible with:

- AS-H810-208 (10", ASP890300 plus three I/O modules)*
- AS-H810-209 (10", ASP890300 plus three I/O modules)*
- AS-H819-209 (19", ASP890300 plus six I/O modules)
- AS-H827-209 (27", ASP890300 plus ten I/O modules)

*Repair/service exchange only.

Power Considerations

If the primary backplane power requirements exceed the ASP890300 capabilities, enough I/O modules must be removed from the primary backplane to bring the current load within specified limits. In this case, an additional backplane and power supply will need to be added in the configuration unless the extra modules can be added to an existing powered backplane. For further reference, see *Power Supply Capacities in Remote Drop Secondary Applications*, p. 45 and *I/O Module Current Requirements*, p. 46.

Secondary backplanes AS-H819-100 and AS-H827-100 support 7 and 11 I/O modules, respectively. Subtract two modules if power supplies need to be added.

Backplane Interconnection Cables

See *Backplane Interconnection Diagrams*, p. 42 for appropriate configurations.

ASCII Port Pinout Comparison

The following table shows how the ASCII port pinouts are used on the J892 and ASP890300.

Terminal	J892 (25 pin)	ASP890300 (9 pin)
1	Shield	Not Used
2	TXD	RXD
3	RXD	TXD
4	RTS	DTR
5	CTS	SGND
6	DSR	DSR
7	Ground	RTS
8	Not Used	CTS
20	DTR	N/A

- The ASP890300 connector shell is chassis ground.
-

Coaxial Cable Interconnection/Terminations

AS-J89X-00X Remote I/O Adapters - These have BNC type connectors which are not compatible with the F style connections on ASP890300 modules. Installers may use BNC Jack to Male "F" Connector Adapters, part number 52-0724-000. The external 75Ω terminator added in series with the coax drop cable must be removed as the ASP890300 is terminated internally.

AS-J890-10X Remote I/O Adapters are compatible in this respect. They have "F" type coaxial cable connectors and are terminated internally.

Replacement of AS-J81X-000 Adapters

Overview

Note: You are reminded the ASP890300 is not compatible with J200 or S901 RIO heads that communicate with J810/J812 modules. Use of the ASP890300 requires the use of an S908 or CRP type RI/O head.

The ASP890300 is not physically compatible if installations use the following adapter models:

AS-J810-000	AS-J812-000
-------------	-------------

In these installations, you will need to:

- replace the primary backplanes (housings)
- perform power calculations to determine if additional supplies are needed (see *I/O Module Current Requirements*, p. 46)
- consider backplane interconnection cables
- review ASCII Port and coaxial cable connections

Primary Backplane Replacement

ASP890300 modules are compatible with:

- AS-H810-208 (10", ASP890300 plus three I/O modules)*
- AS-H810-209 (10", ASP890300 plus three I/O modules)*
- AS-H819-209 (19", ASP890300 plus six I/O modules)
- AS-H827-209 (27", ASP890300 plus ten I/O modules)

*Repair/service exchange only.

Power Considerations

If the primary backplane power requirements exceed the ASP890300 capabilities, enough I/O modules must be removed from the primary backplane to bring the current load within specified limits. In this case, an additional backplane and power supply will need to be added in the configuration unless the extra modules can be added to an existing powered backplane. For further reference, see *Power Supply Capacities in Remote Drop Secondary Applications*, p. 45 and *I/O Module Current Requirements*, p. 46.

Secondary backplanes AS-H819-100 and AS-H827-100 support 7 and 11 I/O modules, respectively. Subtract two modules if power supplies need to be added.

Backplane Interconnection Cables

See *Backplane Interconnection Diagrams*, p. 42 for appropriate configurations.

ASCII Port Pinout Comparison

The following table shows how the ASCII port pinouts are used on the J812 and ASP890300.

Terminal	J812 (25 pin)	ASP890300 (9 pin)
1	GND	Not Used
2	TXD	RXD
3	RXD	TXD
4	RTS	DTR
5	CTS	SGND
6	DSR	DSR
7	SGND	RTS
8	Not Used	CTS
20	DTR	N/A

- The ASP890300 connector shell is chassis ground.
-

Coaxial Cable Interconnection/Terminations

These have BNC type connectors which are not compatible with the F style connections on ASP890300 modules. Unless otherwise accommodated, installers may use BNC Jack to Male "F" Connector Adapters, part number 52-0724-000.

Replacement of Slot Mount PLCs

Compatibility

The ASP890300 is backplane compatible with Slot Mount PLC installations. These include:

- PC-0984-380/1/5; PC-E984-381/5
- PC-0984-480/5; PC-E984-480/5
- PC-0984-680/5; PC-E984-685
- PC-0984-780/5; PC-E984-785

AC Power Connector Rewiring

Rewiring is required to accommodate one 2 terminal and one 3 terminal connector, which include a 115/230VAC jumper selection option as opposed to the switch selectable option in the original units. Rewiring requires a small slotted screwdriver.

	DANGER
	<p>HAZARDOUS VOLTAGE</p> <ul style="list-style-type: none"> ● Disconnect all power before working on equipment. ● Verify correct terminal connections when wiring. <p>Failure to follow this precaution will result in death, serious injury, or equipment damage.</p>

Power Considerations

If replacing high end slot mount PLCs: Both +5VDC I/O power and the Combined load in PC-0984-680/5s and PC-0984-780/5s are rated 1A higher than the ASP890300. If the Primary backplane power requirements exceed the ASP890300 capabilities, enough I/O modules must be removed from the primary backplane to bring the current load within specified limits. In this case, an additional backplane and power supply will need to be added in the configuration unless the extra modules can be added to an existing powered backplane. See *I/O Module Current Requirements, p. 46* and *Power Supply Capacities in Remote Drop Secondary Applications, p. 45*.

Secondary backplanes AS-H819-100 and AS-H827-100 support 7 and 11 I/O modules, respectively. Subtract two modules if power supplies need to be added.

Backplane Interconnection Cables

For more information, see *Backplane Interconnection Diagrams, p. 42*

Backplane Interconnection Diagrams

ASP890300 with No Secondary Power Supply

The following illustration shows ASP890300 configurations with no secondary power supply.

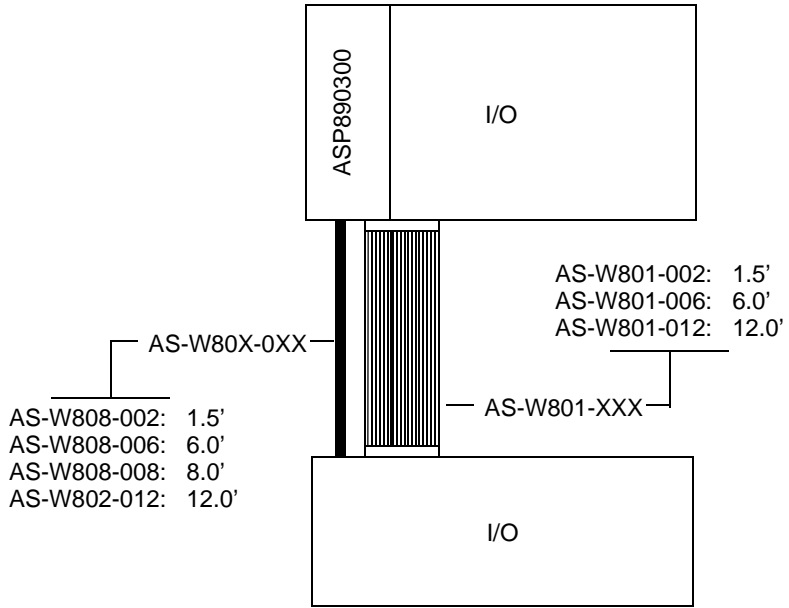

ASP890300 with a Secondary Power Supply Installed

The following illustration shows ASP890300 configurations with a secondary power supply.

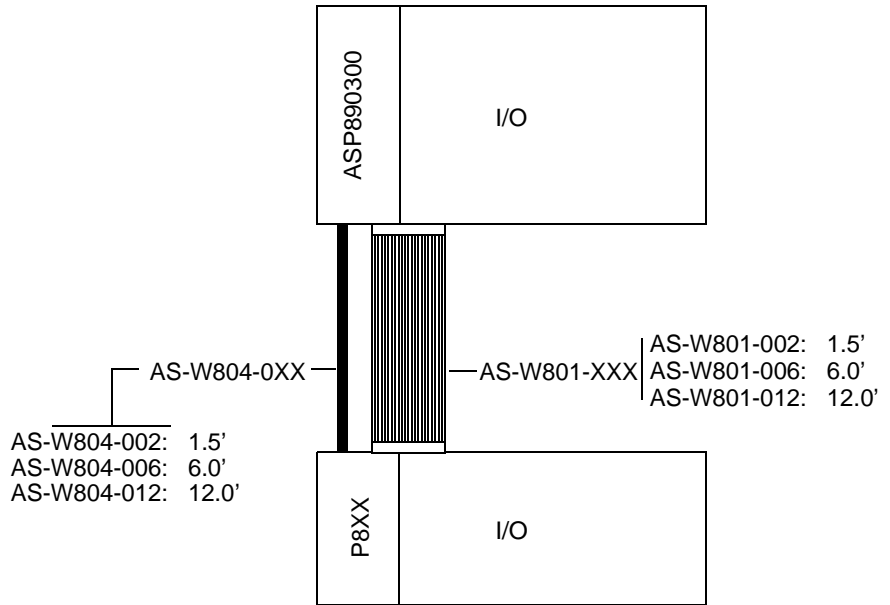

ASP89X Capacity Information

Capacity

Type	Current Capacity (A)			Max Combined +5V and +4.3V Load	Input
	+5.0V	+4.3V	-5.0V		
AS-P89X-000	3.0	3.0	0.25	3.0	115/230VAC, 0.75A @ 115VAC, or 24VDC, 2A
ASP890300	7.0	6.0	0.5	7.0	115VAC, 1.1A, 50/60Hz 230VAC, 0.65A, 50/60Hz 24VDC, 4A

Power Supply Capacities in Remote Drop Secondary Applications

Power Supply Capacities

Type	Current Capacity (A)			Max Combined +5V and +4.3V Load	Input
	+5.0V	+4.3V	-5.0V		
AS-P800-003	2.5	10.0	0.5	12.5	115/230VAC, 1.5A @115VAC
AS-P801-001	5.0	10.0	0.5	15.0	115/230VAC, 1.7A @115VAC
AS-P802-001	2.5	10.0	0.5	12.5	24VDC, 8A
AS-P810-001	5.0	5.0	0.3	10.0	115/230VAC, 1.6A @115VAC
AS-P830-000	5.0	6.0	0.5	6.0	115/230VAC, 0.5A @115VAC, or 24VDC, 2A
AS-P840-000	5.0	10.0	0.5	15.0*	115/230VAC, 1.1A @115VAC

*55° C max; 12A max @ 60° C

I/O Module Current Requirements

Requirements

Module	Current (mA) @		
	+5.0V	+4.3V	-5.0V
AS-B802-008	76	240	0
AS-B803-008	27	1	2
AS-B804-116	76	480	0
AS-B804-116	76	480	0
AS-B804-148	76	480	0
AS-B805-016	40	1	14
AS-B806-032	210	1	0
AS-B806-124	210	1	0
AS-B807-132	80	2	0
AS-B808-016	76	480	0
AS-B809-016	42	1	15
AS-B810-008	50	240	0
AS-B814-001	120	220	0
AS-B814-002	120	220	0
AS-B814-108	107	800	0
AS-B817-116	25	2	8
AS-B817-216	25	2	8
AS-B820-008	90	80	0
AS-B821-008	20	0	0
AS-B821-108	27	1	10
AS-B824-016	32	260	0
AS-B825-016	27	1	15
AS-B826-032	90	1	0
AS-B827-032	30	1	0
AS-B828-016	32	220	0
AS-B829-016	120	0	0
AS-B829-116	21	1	0
AS-B832-016	32	235	0
AS-B833-016	27	2	0

Module	Current (mA) @		
	+5.0V	+4.3V	-5.0V
AS-B836-016	50	603	0
AS-B837-016	40	1	15
AS-B838-032	160	1	0
AS-B840-008	120	220	0
AS-B840-108	67	400	0
AS-B842-008	120	220	0
AS-B846-001	65	1	0
AS-B846-002	65	1	0
AS-B849-016	40	1	15
AS-B853-016	40	1	15
AS-B855-016	80	1	0
AS-B862-001	180	220	0
AS-B863-001	180	220	0
AS-B863-032	250	0	0
AS-B863-132	350	10	0
AS-B864-001	100	100	0
AS-B865-001	400	600	0
AS-B868-001	180	220	0
AS-B869-001	180	220	0
AS-B872-002	540	220	0
AS-B872-011	240	880	0
AS-B872-100	475	5	0
AS-B872-200	750	5	0
AS-B873-001	400	440	0
AS-B873-002	300	300	0
AS-B873-011	300	440	0
AS-B873-012	300	300	0
AS-B875-001	300	440	0
AS-B875-002	300	300	0
AS-B875-011	300	440	0
AS-B875-012	300	300	0
AS-B875-102	650	975	0
AS-B875-111	500	900	0

Module	Current (mA) @		
	+5.0V	+4.3V	-5.0V
AS-B875-200	550	10	0
AS-B881-001	30	1	0
AS-B881-108	285	240	0
AS-B881-508	300	0	0
AS-B882-032	300	10	0
AS-B882-116	350	10	0
AS-B882-239	188	0	0
AS-B883-001	667	0	0
AS-B883-101	1000	0	0
AS-B883-111	1000	0	0
AS-B883-200	400	5	0
AS-B883-201	640	5	0
AS-B884-002	50	2	0
AS-B885-001	500	1760	0
AS-B885-002	500	1760	0
AS-B885-100	25	0	0
AS-B885-101	25	0	0
AS-B885-110	25	0	0
AS-B885-111	25	0	0
AS-B984-100	0	0	0
AS-B984-101	0	0	0

ASP890300 Executive Software Reflash



B

At a Glance

Purpose

The purpose of this chapter is to provide guidelines for reflash of executive software used in the processor. Executive software can be obtained on the Schneider web site, www.schneiderautomation.com, by selecting the appropriate Firmware location.

The ASP890300 executive software is resident in flash RAM and may be updated as required. Reflash requires a PC with an available serial port and loaded with Schneider panel software. Concept contains utilities that may be used. Versions of ProWORX and Modsoft that support Quantum will contain reflash utilities.

What's in this Chapter?

This chapter contains the following topics:

Topic	Page
Interconnection	50
Communication Parameters	51
Procedure	52

Interconnection

Cables

Cables that may be used to connect the panel PC serial port to the ASP890300 ASCII port 1 are:

- AS-W952-012 Programming Cable, 12'
 - 990NAA26320 Programming Cable, 12'
 - 990NAA26350 Programming Cable, 50'
-

Communication Parameters

RTU and ASCII Mode

Communication parameters for RTU and ASCII modes are shown here:

RTU Mode	9600 baud, 8 data bits, Even parity, 1 stop bit
ASCII Mode	9600 baud, 7 data bits, Even parity, 1 stop bit

Procedure

ASP890300 Executive Reflash Procedure

Use the following procedure to reflash the ASP890300 executive software.

Step	Action
1	At a time when system operation can be interrupted, turn off power to the ASP890300 and other supplies in the affected drop. Ensure the ASP890300 front panel power switches are in the OFF position.
2	Remove module from the backplane. Note the position of the MODE SELECT switch. The switch should be returned to that position when the reflash sequence has been completed. Set the MODE SELECT switch to position 7 (RTU mode) or 8 (ASCII mode)
3	Connect a communication cable from the panel software PC serial port to the ASP890300 ASCII Port 1 ONLY. Port 2 is not supported.
4	The module may be reinserted into the system backplane and powered. It may also be flashed on the bench, e.g. plugged into a spare non-system backplane and powered on. After power is turned on, the Comm Active LED (third from the top) will blink 9 times, then pause, blink 9 times and pause, etc. This indicates the module is in kernel mode and ready to be flashed.
5	In panel software, display the exec download menu.
6	Use the Direct MB Device selection. The address used should be that selected by the ASP890300 address rotary switches. If connected to a Modbus network, insure there are no address conflicts. Set the communication parameters to those listed above per the mode selection, either RTU or ASCII, and perform the normal executive software loading procedure.
7	After the transfer is complete, the panel software will indicate a timeout error, and there will be no further communication to the P890. Look at the ASP890300 LEDs for confirmation that the flash sequence has succeeded. When an exec download has successfully completed, the front panel LEDs will repeatedly blink in the same sequence from top to bottom as that following a power up. If the operation fails, the Comm Active LED will continue to flash as noted in Step 4. NOTE: Some versions of the built-in exec loader in ProWORX may lock up at the end of the transfer.
8	Power down the ASP890300.
9	Unplug the programming cable from the ASCII Port. Remove the module from its backplane. Set the MODE SELECT switch back to the correct position (noted in Step 2).
10	Insert the ASP890300 into the rack. Turn on power to it and other supplies as required. The ASP890300 should operate normally.

CE Requirements for ASP890300/ 800 Series I/O Systems

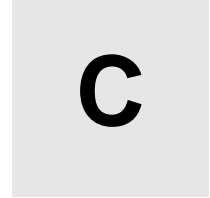

At a Glance

Purpose

This chapter covers the installation requirements necessary to maintain compliance with the European Directive for EMC 89/336/EEC for certain 800 Series I/O system components. The majority of 800 Series I/O components are approved per these requirements; however, examine your particular product/shipping carton for the CE mark to ensure approval.

What's in this Chapter?

This chapter contains the following topics:

Topic	Page
Requirements	54
Installation	55
Parts List	56

Requirements

Requirements List

The following requirements should be followed for installations complying with the CE marking.

- All wiring for power supply and I/O lines must be in grounded steel conduits (EMT) or must use braided shielded cable. If shielded cable is used, the braid must have 80% or more shield coverage, and the outside diameter of the braid (without jacket) must be in the range of 0.189 ... 0.237 in (4.8 ... 6.0 mm).
 - All cable shields must be grounded, using clips on the Grounding Bar (Modicon part number CER001). Shield is not terminated at module field connector.
 - Install braided earth ground as shown in Figure 1 from building earth ground to grounding clip (or clips as required) and to backplane ground reference.
 - Use a 110/220 Vac Line Filter (Schaffner part number FN670-30/6). Install as shown in the AC power input figure.
-

Installation

Remote Drop Example

The following graphics show the correct CE installation for a remote drop.

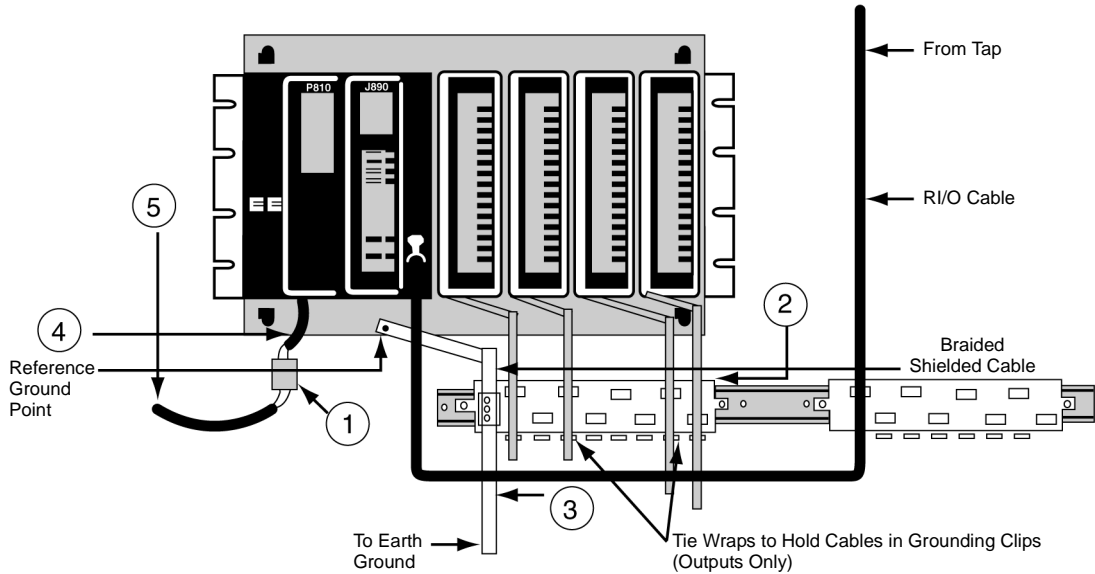

Typical CE Installation for a Remote Drop

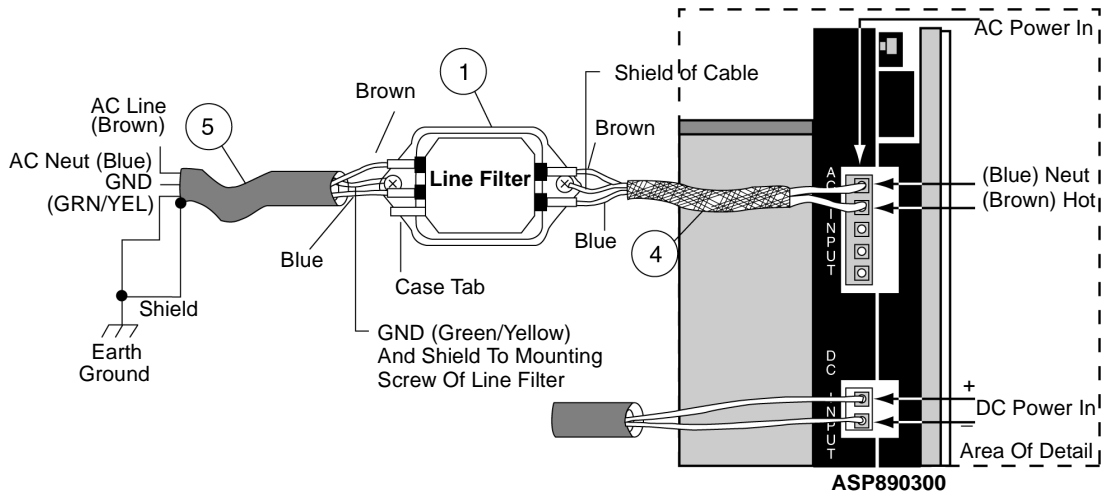

Parts List

Manufacturers Part Numbers/ Instructions

Callout	Vendor	Part Number	Description	Instructions
1	Schaffner	FN670-3/06	Line Filter (Fast on terminals) Dimensions: Length: 3.4 in (85 mm) Width: 2.2 in (55 mm) Height: 1.6 in (40 mm) Mounting Holes: 0.2 in (5.3 mm) dia.: 3 in (75 mm) centerline mounted Fast on Terminals: 0.25 in (6.4 mm)	Install next to the 984 CPU.
2	Modicon	CER001 or equivalent	Grounding Bar	All cable shields must be grounded. NOTE: Not required if using steel conduit.
3			Flat Ground Braided Cable	
4	Oflex	35005 3 conductor 100cy Series	Shielded Cable	The maximum length is 30 in (760 mm); the shield is terminated at the EMI Line Filter, open at CPU end. The third conductor is not used.
5	Oflex	35005 3 conductor 100cy Series	Shielded Cable	Terminate the shield at panel ground, at EMI Filter.

Index



Numerics

990NAA26320, 50
990NAA26350, 50

A

AC power, 16
AC power connector
 rewiring, 36, 41
agency approvals, 32
ASCII cable distance, 22
ASCII port
 pin layout, 23
ASCII port addressing
 J892, 20
 J892 (mode 5/6), 21
 P892, 20
ASCII port capacity, 18
ASCII port connector, 36
ASCII port handshake
 switch settings, 21
ASCII port interface connector, 22
ASCII port parameters, 22
ASCII port pinouts
 ASP890300, 38, 40
 J892, 38, 40
ASCII ports testing, 31
AS-J81X-000 adapters
 equipment replacement, 39
AS-J89X-X0X adapters
 equipment replacement, 37

ASP89X
 capacity, 44
AS-P89X-000 adapters
 equipment replacement, 36
AS-W952-012, 50

B

backplane interconnection, 39, 41
 configuration, 37
 no secondary power supply, 42
 secondary power supply, 43
backplanes, 17

C

cables
 interconnection, 50
capacity
 ASP89X, 44
 power supply, 45
 remote drop secondary applications, 45
coaxial cable
 interconnection/termination, 38, 40
communication parameters
 ASCII, 51
 RTU, 51
compatibility, 12
 backplanes, 17
confidence tests, 24
 power-up, 24
 run-time, 24

configuration, 17

D

DC power, 16
diagnostics, 24
drop I/O, 18

E

electromagnetic emissions testing, 31
equipment replacement
 AS-J81X-000 adapters, 39
 AS-J89X-X0X adapters, 37
 AS-P89X-000 adapters, 36
 primary backplane, 37, 39
 slot mount PLCs, 41

G

general description, 12

I

I/O drop address
 switch settings, 20
I/O module
 requirements, 46
I/O supply, 16
installation, 28

L

LED indicator
 error codes, 25
LED Indicators, 15

M

mounting, 12

P

panel software requirements, 27

pin layout
 ASCII port, 23
 remote device, 23

PLCs

 slot mount, 41
power, 13
 AC power input connections, 16
 DC power input connections, 16
 I/O supply, 16
 input power connectors part numbers, 17
 primary backplane, 37, 39, 41
power supply
 capacity, 45
power supply testing, 30
primary backplane
 equipment replacement, 37, 39
 power requirement, 39
 power requirements, 37, 41
programming cable
 990NAA26320, 50
 990NAA26350, 50
 AS-W952-012, 50

R

reflash procedure, 52
remote device
 pin layout, 23
remote drop secondary applications
 capacity, 45
remote I/O, 18
rewiring
 AC power connector, 36, 41
RIO interface testing, 30

S

secondary power supply
 backplane interconnection, 43
 none installed, 42
slot mounted PLCs
 equipment replacement, 41
specifications, 29

switch settings

- ASCII port handshake, 21
- I/O drop address switch, 20
- J892 (mode 5/6) ASCII port addressing, 21
- J892 ASCII port addressing, 20
- mode select switch, 19
- P892 ASCII port addressing, 20
- switch label, 19

T

temperature/vibration testing, 31

testing

- ASCII ports, 31
- electromagnetic emissions, 31
- power supply, 30
- RIO interface, 30
- temperature/vibration, 31

V**view**

- front, bottom, and left side, 13
- right side, 14

