

airtrol CPC 200 / 210 Fully Automatic Measuring and Calibration System for pH

Operating Instructions

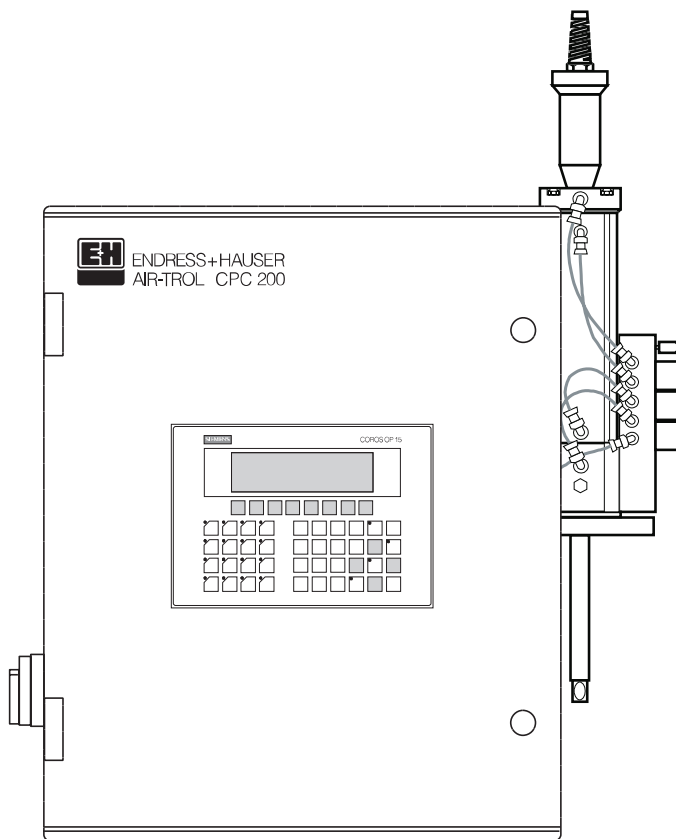
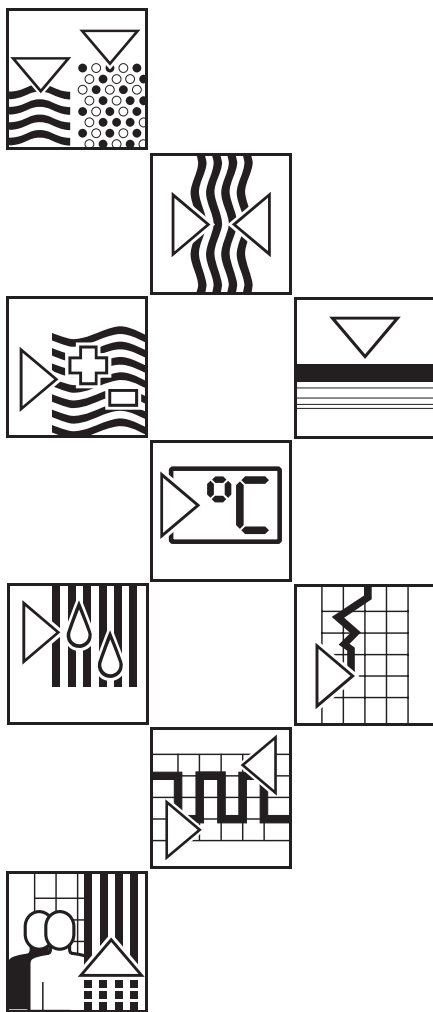


Table of contents

1.	General	2-3
1.1	Unpacking	2
1.2	Application	2
1.3	Ordering system	3
2.	Measuring system	4
3.	Installation	5-10
3.1	Basics for installation	5
3.2	Installation overview	6
3.3	Pneumatic connection	8
3.4	Compressed air connection	10
3.5	Water connection	10
3.6	Buffer and cleaner solutions	10
3.7	Connection to retractable pH assembly	10
4.	Electrical connection	11-14
4.1	Basics for connection	11
4.2	Connection diagram	11
4.3	Connection of CPC 200 to CPC 210	12
4.4	Connective networking of several systems via Profibus	13
5.	Start-up	15-20
5.1	General	15
5.2	Start-up sequence	15
6.	Operation	21-42
6.1	Modes of operation	23
6.2	Airtrol menu structure	24
6.3	Single menus	26
6.4	Service	34
6.5	"Auto(matic)" mode of operation	35
6.6	External start inputs	42
6.7	Relay status	42
7.	Error diagnosis	43-46
7.1	List of error messages	44
8.	Technical data	47
9.	Appendix	48-52
9.1	Cleaning agents for cleaner reservoir	48
9.2	Cleaning	48
9.3	Maintenance	48
9.4	Bus cable properties	49
9.5	System control S5-95U – Display and operating elements and interfaces	49
9.6	Accessories	50
9.7	Index	51

1. General

These operating instructions describe the automatic cleaning, pH signal monitoring and calibration system of the Airtrol CPC 200 / 210.



Note:

Separate operating instructions are required for the built-in pH measuring transmitter Mycom CPM 151-P and the retractable assembly Proffit CPA 463 or CPA 463S.

- pH / temperature measuring transmitter / controller Mycom CPM 151-P (BA 093C/07/en)
- Retractable assembly for pH / redox measurement Proffit CPA 463 (BA 007C/07/en)
- Retractable assembly for pH / redox measurement Proffit CPA 463S (BA 151C/07/en)

1.1 Unpacking

- Inspect for any damaged packaging! The post office or freight carrier must be informed of any damage. Damaged packaging material must be retained until the matter has been settled!
- Verify that the contents are undamaged! Inform the post office or freight carrier as well as the supplier of any damage.
- Check that the delivery is complete and agrees with the shipping documents and that the unit type and version match the nameplate (see fig. 1.1).

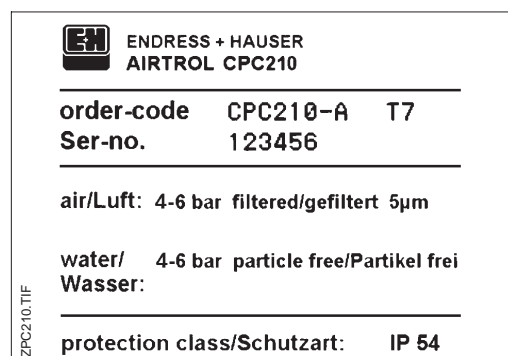
If you have any questions, consult your supplier or your competent Endress+Hauser sales center (see back cover of these operating instructions for addresses).

1.2 Application

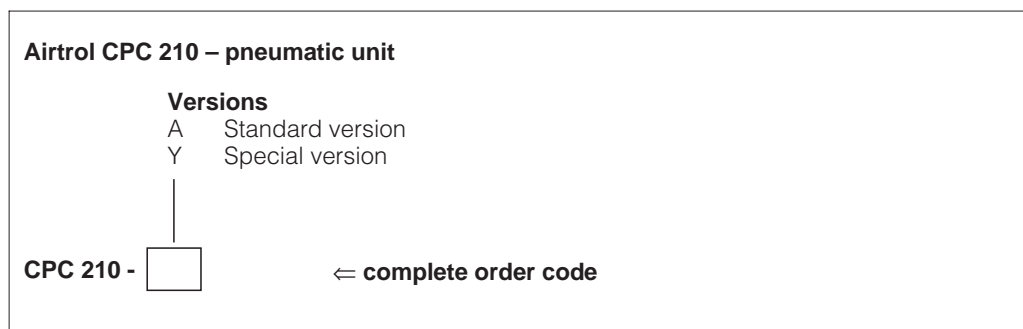
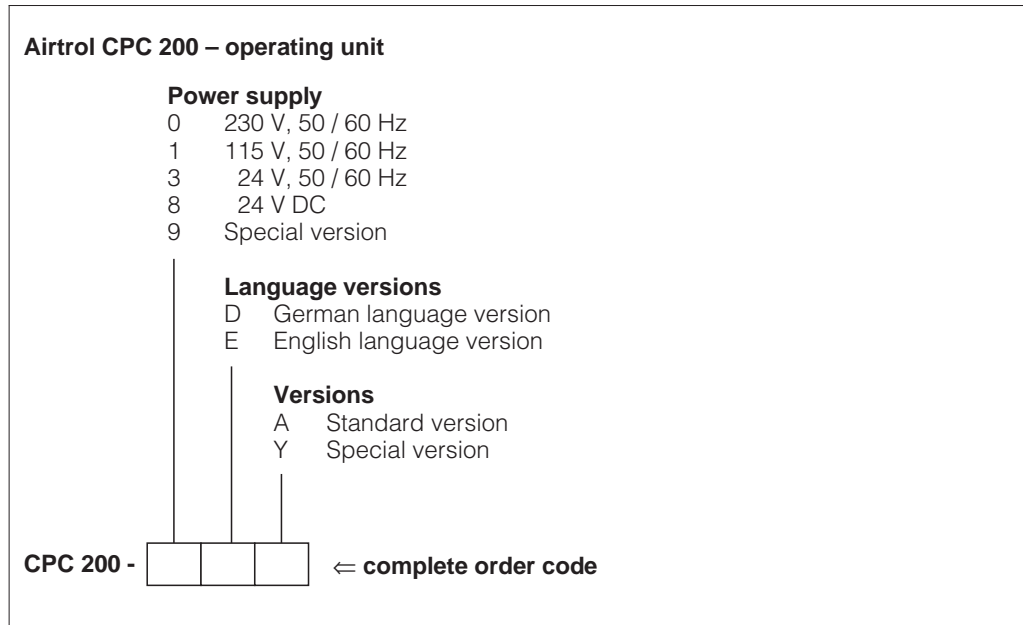
The Airtrol is an automatic cleaning, pH signal monitoring and calibration system.

When used in conjunction with the retractable pH / redox assembly Proffit, the Airtrol permits automatic cleaning and calibration of pH electrodes.

Fig. 1.1: Nameplates
left: Airtrol CPC 200
right: Airtrol CPC 210



1.3 Ordering system



2. Measuring system

The complete measuring system (fig. 2.1) comprises

- the operating unit CPC 200 and the pneumatic unit CPC 210
- a Proffit assembly
- a pH measuring cable CPK 7
- a connecting cable from the operating unit to the pneumatic unit (5 m, 14 wires)

- A control line from the pneumatic unit to the Proffit assembly (5 m pneumatic hoses in protective hose).

Connective networking of several systems (max. 10) is possible via Profibus (fig. 2.2).

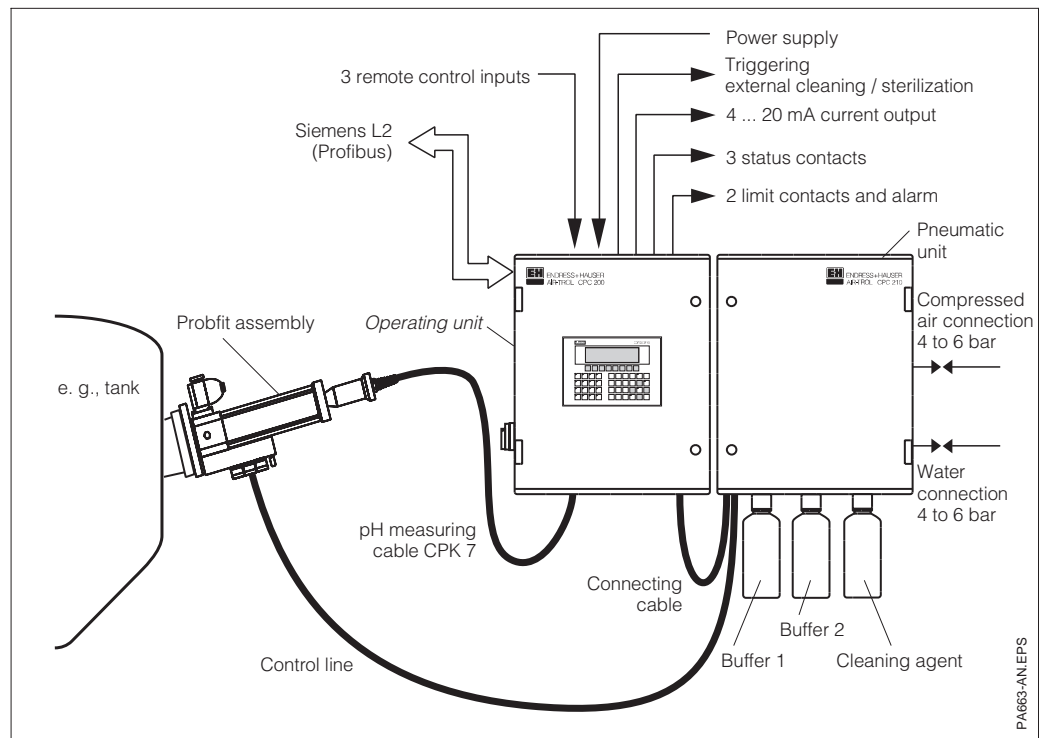


Fig. 2.1: Single system

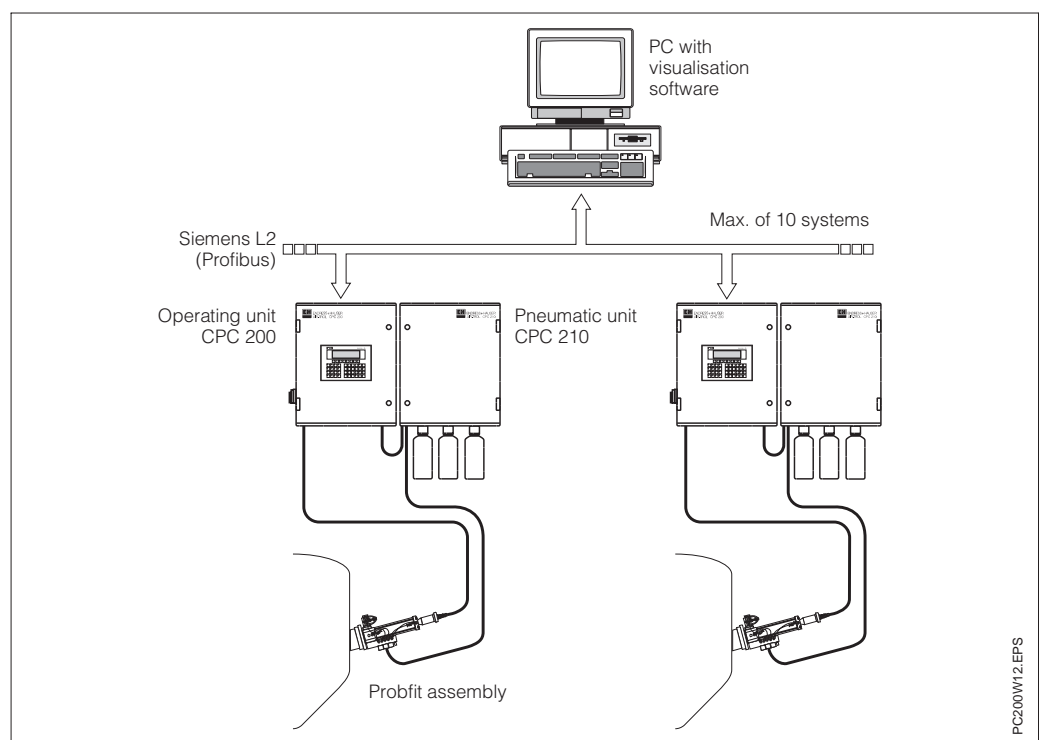


Fig. 2.2: Connective networking of several systems

3. Installation

3.1 Basics for installation



Note:

- Outdoor installation of system requires complete weather protection (sun and rain protection)!
- Ingress protection is IP 54.
- **Operating unit CPC 200**
 - Install at eye level to facilitate operation and assure readability of the system.
- **Pneumatic unit CPC 210**
 - Install next to the operating unit CPC 200 if possible to facilitate troubleshooting, maintenance, etc.
 - Make sure water and compressed air connections are easily accessible.
 - The standard length of the pneumatic connecting line between the pneumatic unit CPC 210 and the retractable pH assembly is 5 m.
 - The cleaner and buffer bottles are screwed onto the cabinet from below.

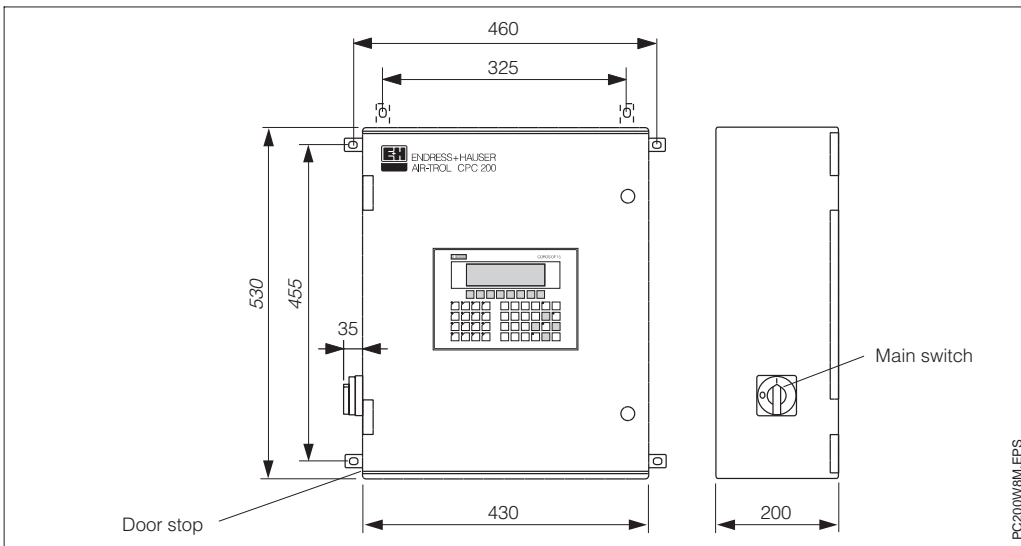


Fig. 3.1: Dimensions CPC 200

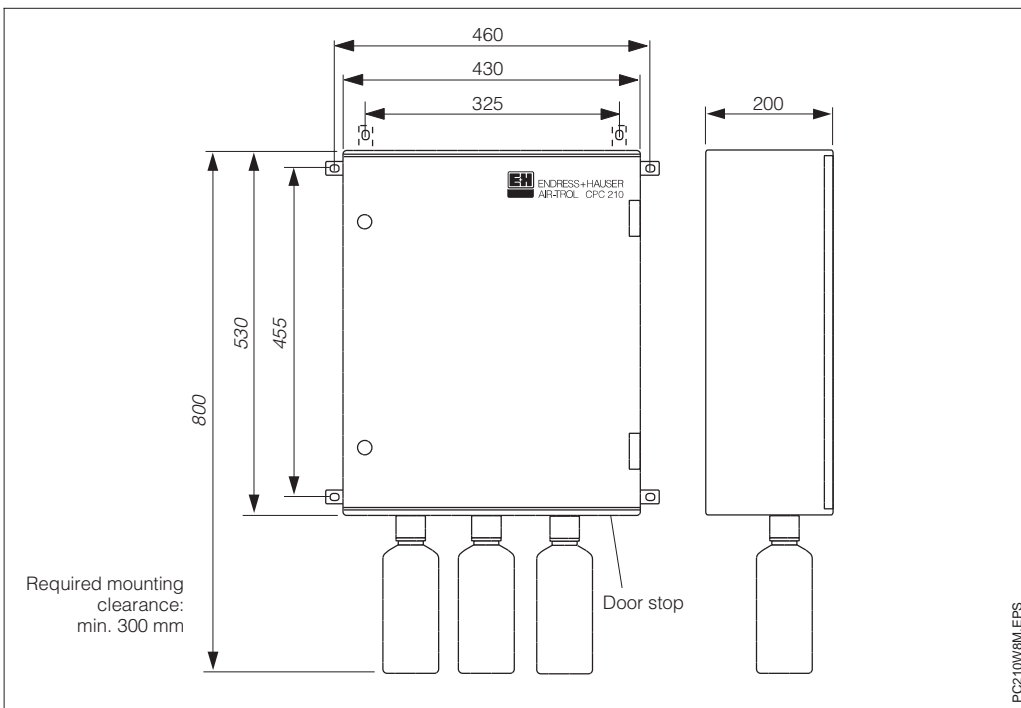


Fig. 3.2: Dimensions CPC 210

3.2 Installation overview

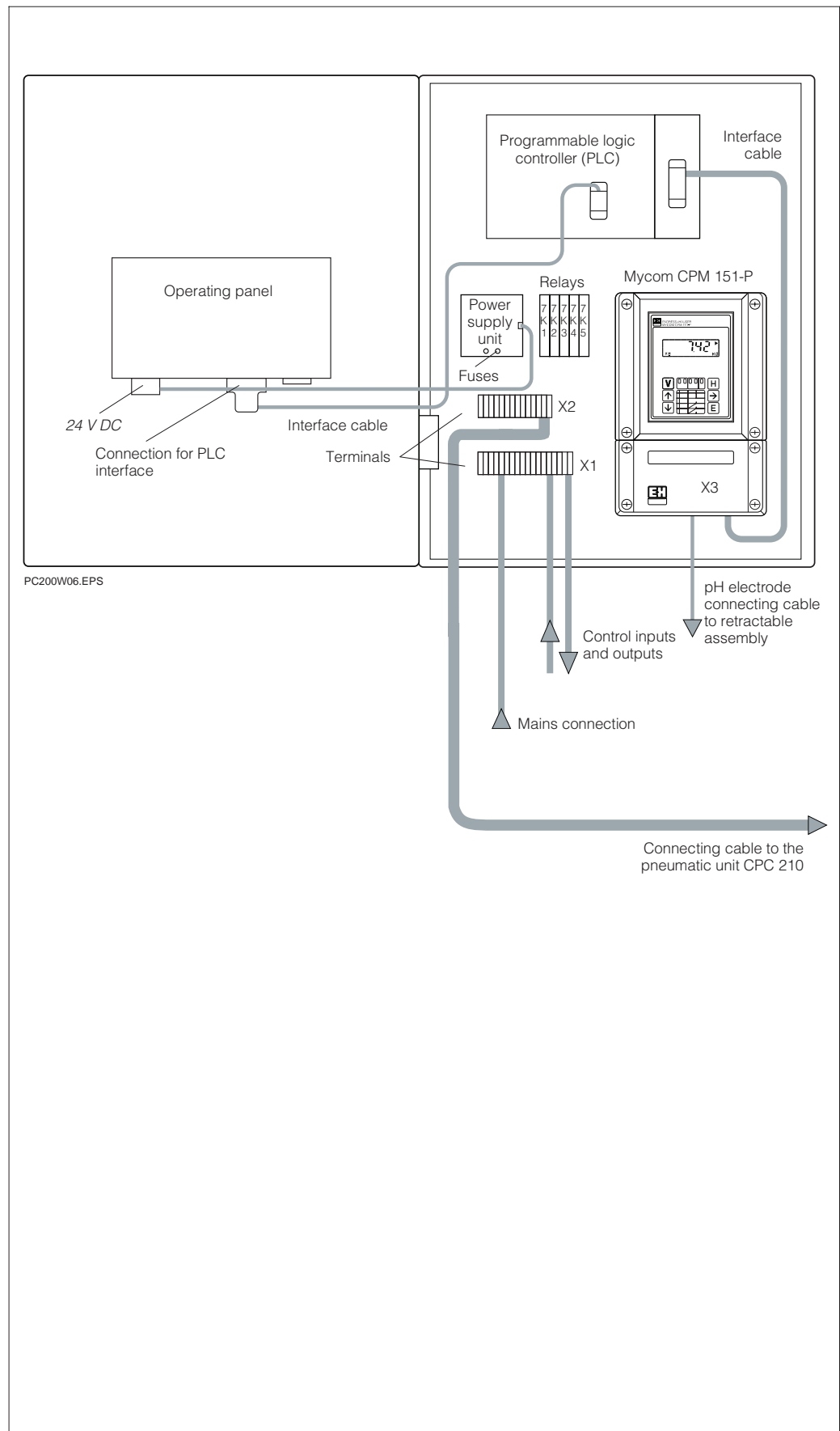


Fig. 3.3: Operating unit CPC 200 (open)

Notes:

- Relay designations (from left to right): 7K1, 7K2, 7K3, 7K4, 7K5
- Terminal block X3 is located inside the pH measuring transmitter Mycom CPM 151-P.

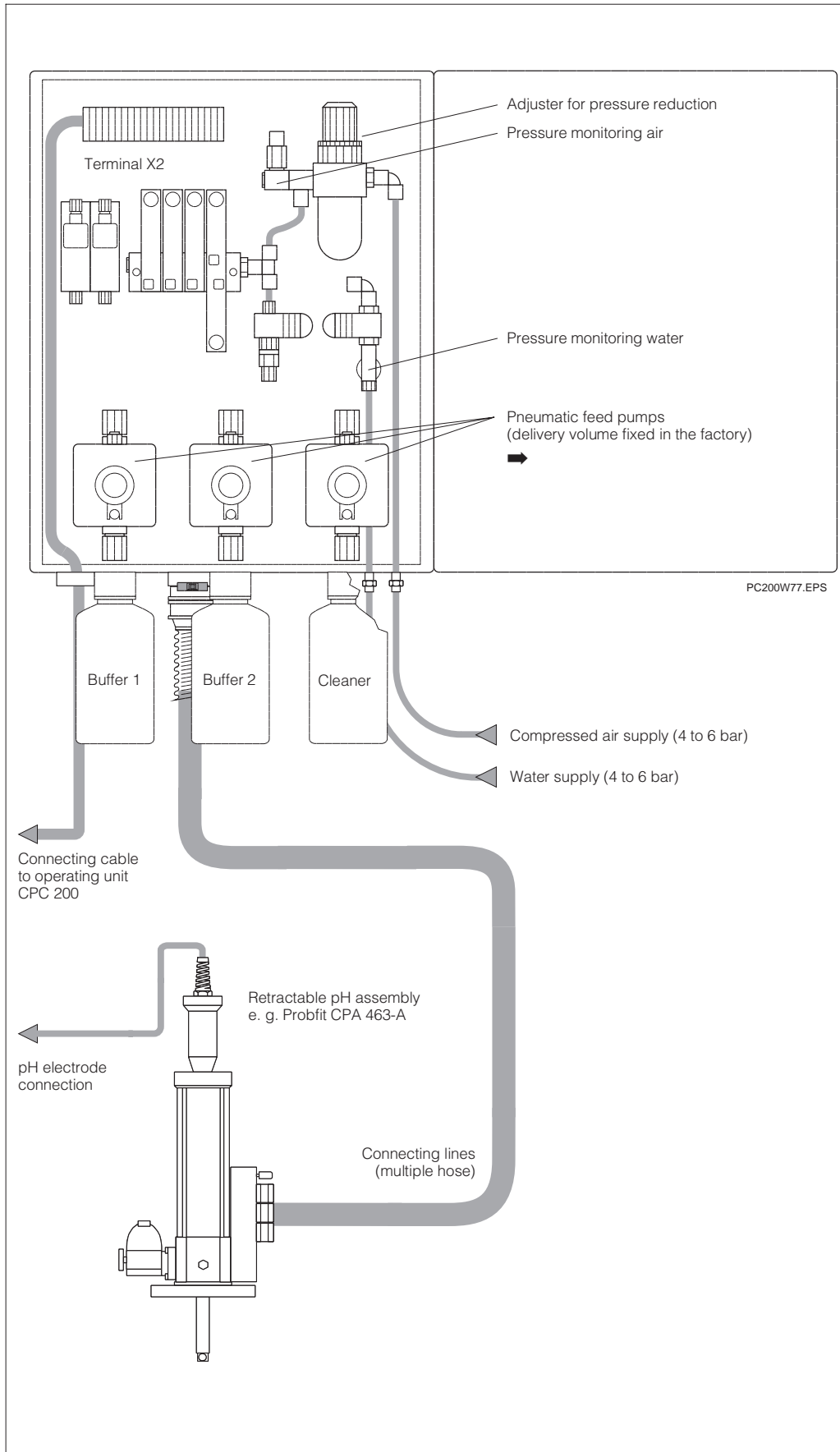


Fig. 3.4: Pneumatic unit CPC 210 (open)

Note:

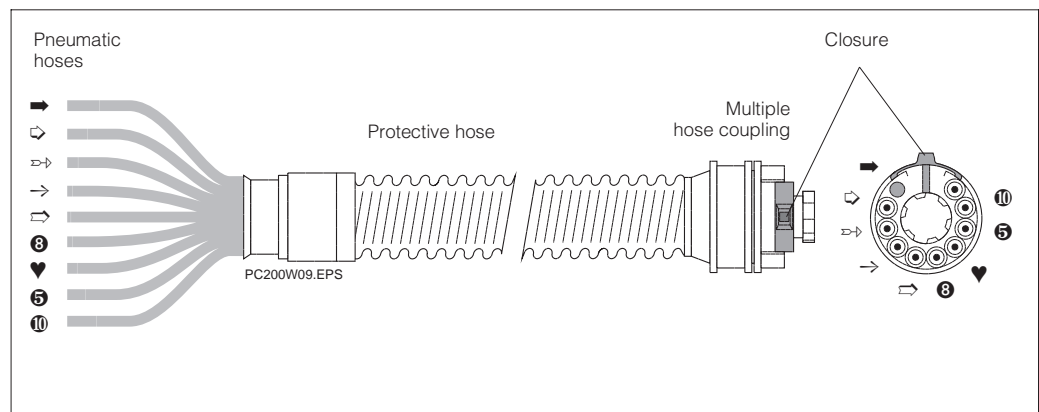
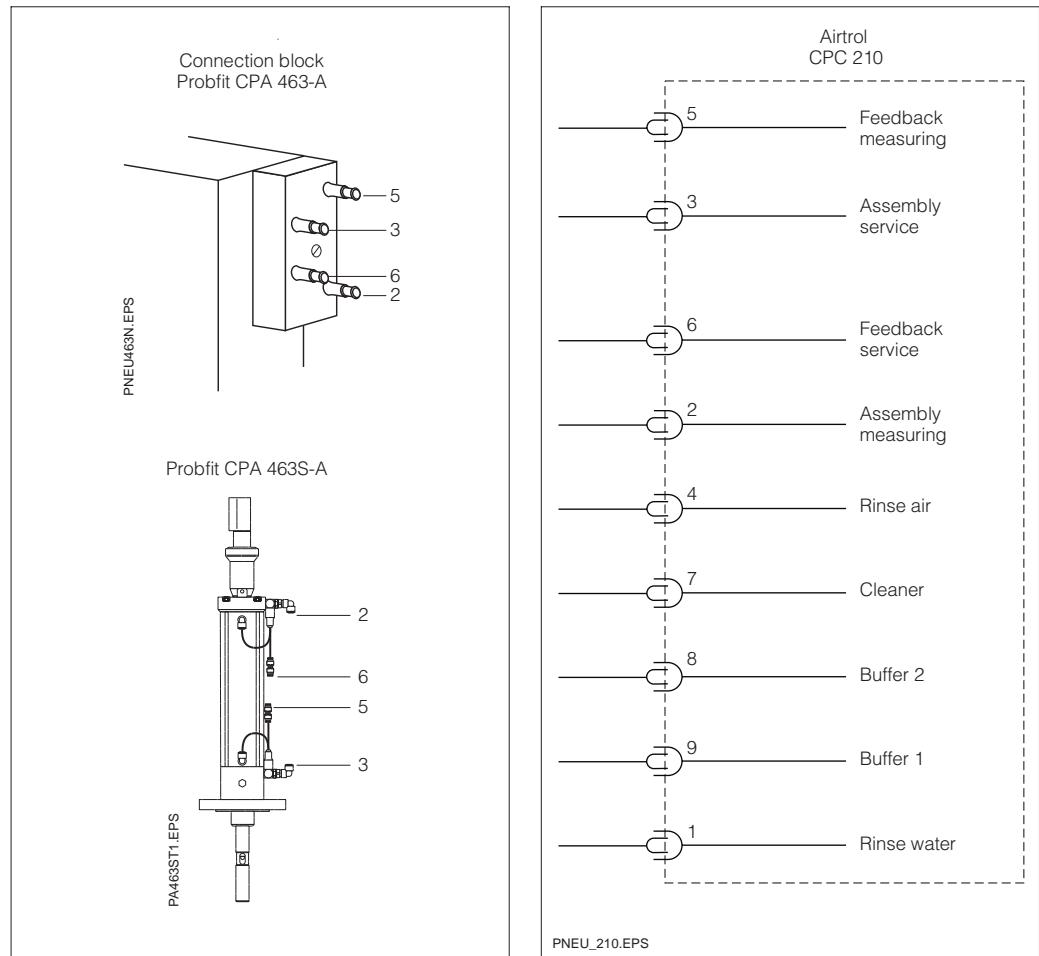
- ➔ The delivery volume adjustments for buffer solutions 1 and 2 and cleaning solution must not be changed.

3.3 Pneumatic connection



Note:

- Please read chapters 3.2 and 3.4 of the Probit operating instructions before connecting the pneumatic unit CPC 210 to the retractable assembly Probit.
- The distance between the pneumatic unit CPC 210 and the retractable assembly Probit must not exceed 5 m.



3.3.1 Flow diagram

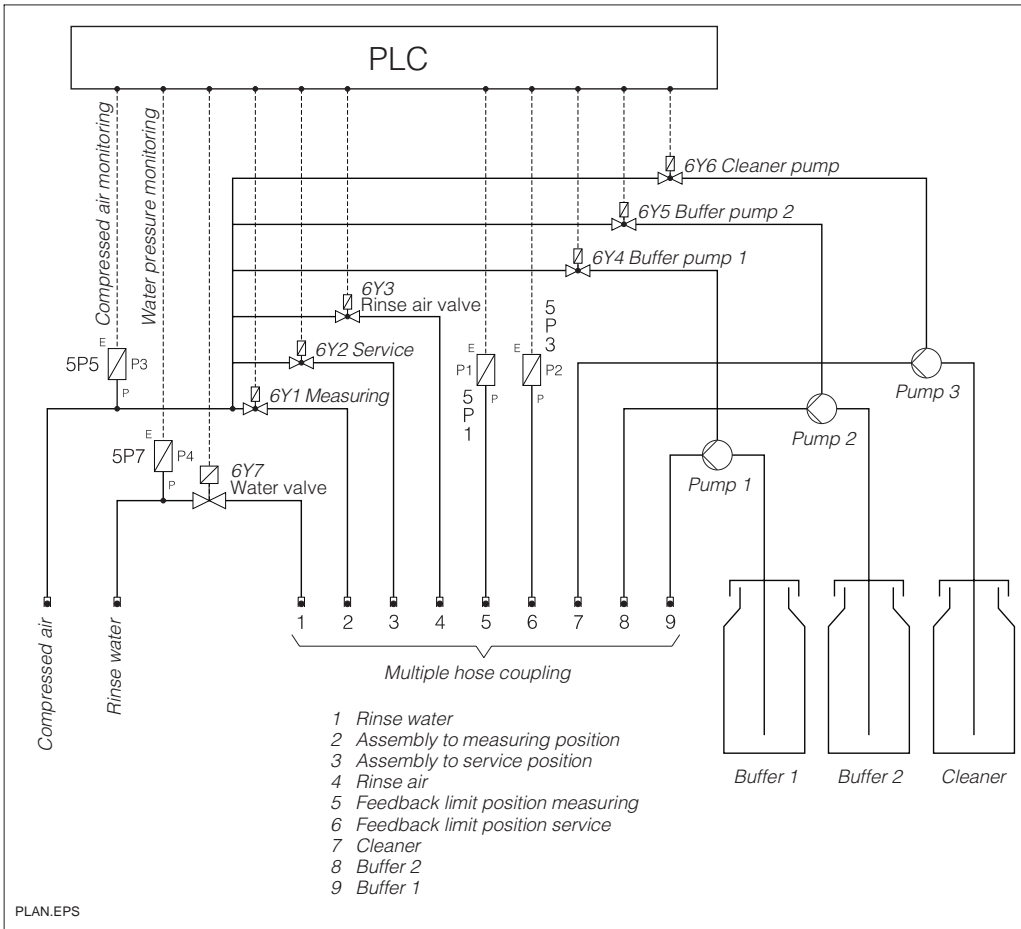


Fig. 3.7:
Flow diagram for the
pneumatic unit CPC 210

3.4 Compressed air connection

The compressed air is supplied via an ID4 / OD6 hose (4 mm inside diameter, 6 mm outside diameter).

The compressed air is to be supplied to the pneumatic unit CPC 210 via a line with a large diameter.

- Air quality: filtered (5 µm), water and oil-free
- Air pressure: 4 to 6 bar
- Air flow requirement: max. 20 l/min



Note:

- Compressed air pressures below 4 bar produce the error message "Air pressure too low".
- Please note the applicable regulations for accident prevention and safety for compressed air systems.
- We recommend installing a stopcock close to the compressed air connection.

3.5 Water connection

Screw-type couplings (SERTO system) are used for the water connections (both hoses and pipes with an inside diameter of 4 mm and an outside diameter of 6 mm).

- Water quality: city water, free of solid particles
- Water pressure: 4 to 6 bar



Note:

- Water pressures below 4 bar will produce the error message "Water pressure too low".
- We recommend installing a stopcock close to the water connection.

3.6 Buffer and cleaner solutions

The suction lines for the buffer and cleaning solutions go through the cabinet floor directly into the buffer and cleaner solution bottles screwed onto the cabinet.

The suction hoses can be extended if larger buffer and cleaning solution containers are to be used.

The suction height of the pumps is max. 1.5 m.



Warning:

Mechanical shocks on the buffer and cleaner solution bottles or horizontal position of the cabinet may cause penetration of fluid.

3.7 Connection to retractable pH assembly

- Connect the pneumatic hoses 1 to 9 to the retractable pH assembly Probit CPA in accordance with the pneumatic connection diagram (see fig. 3.5). Also refer to the operating instructions for the retractable pH assembly.
- The connections for rinse air, buffer, cleaning agent and rinse water are connected on the assembly.
- Plug in the multiple hose coupling when connecting the pneumatic unit CPC 210 and lock the closure in the "Lock" position.

4. Electrical connection

4.1 Basics for connection

**Caution:**

- The unit must be grounded before start-up!
- If faults cannot be remedied, the unit must be removed from service and secured to prevent accidental start-up.
- Before carrying out any installation or maintenance work, the system is to be shut down and the pressure in the hoses is to be released, i. e. set the main switch to OFF and shut off the media (caution: hoses may contain cleaner solution!).

**Warning:**

- The notes and warnings in these operating instructions must be strictly adhered to!
- Maintenance work may only be carried out by qualified personnel if the unit remains energised!
- Local power supply company regulations are to be observed!
- Use conductor cross sections in accordance with VDE 0100!
- Retighten all screw terminals before starting up the system!

**Note:**

- This system has been built and tested in accordance with VDE 0660 T500 and left the manufacturer's works in perfect condition.
- Any faults in the system may be remedied with the aid of the error list in chapter 7.1.
- Interventions in or changes to the system are impermissible and will void the warranty.
- After installing and connecting the system and assemblies, the entire system should be checked for proper function.

4.2 Connection diagram

CPC 200 / 210 and
external connections

Refer to the nameplate for the mains power requirements.

The internal supply voltage of the Airtrol is 24 V DC.

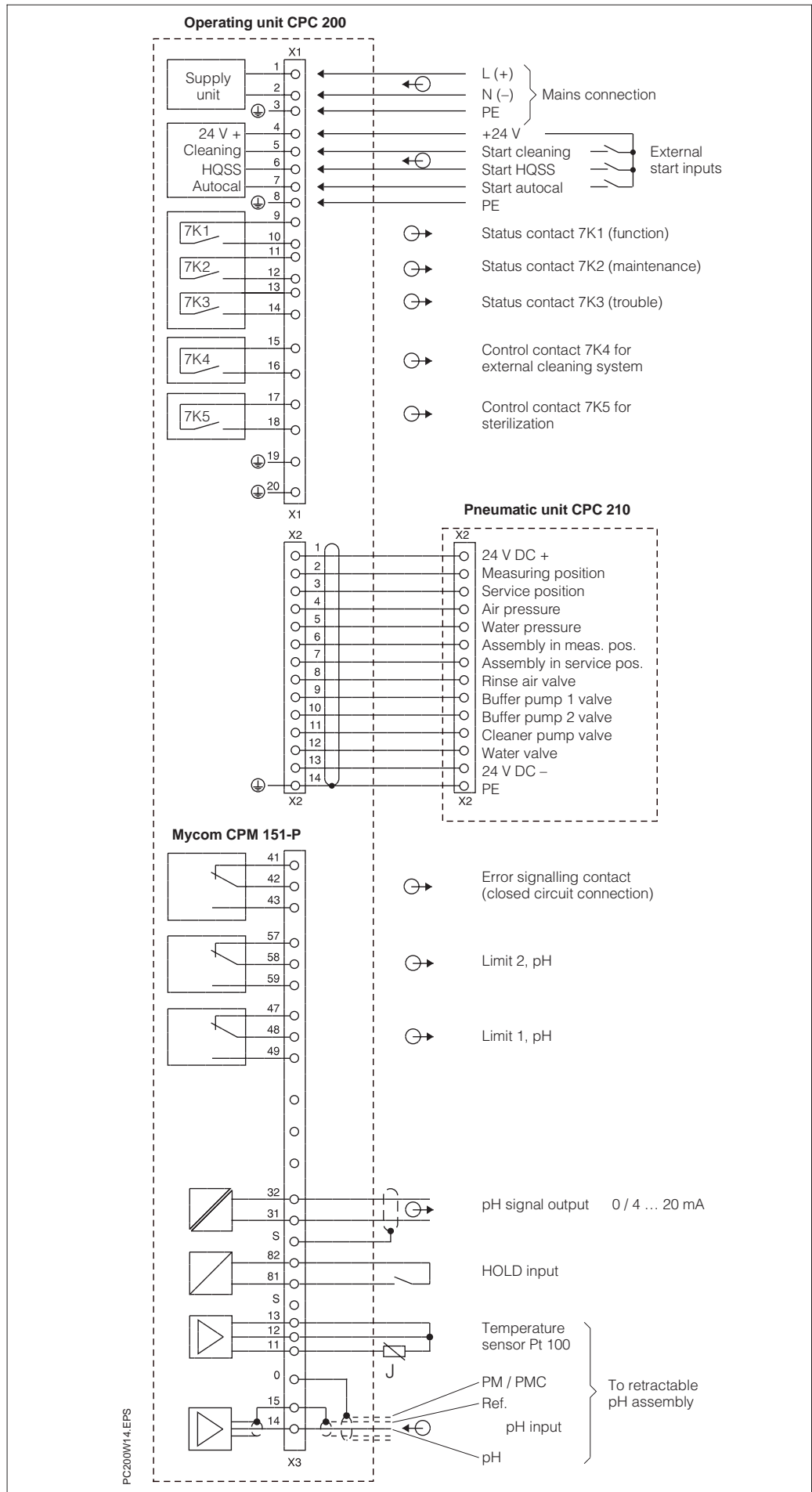


Fig. 4.1: Connection diagram for Airtrol CPC 200 / 210, Mycom CPM 151-P and retractable pH assembly

4.3 Connection of CPC 200 to CPC 210

The operating unit CPC 200 is connected to the pneumatic unit CPC 210 by means of a 14-wire cable.

4.3.1 Connection type selection for pH transmitter Mycom CPM 151-P

- When a retractable Proffit assembly made of PVC or PVDF material is used, the asymmetrical high-impedance type of connection must be chosen on the measuring transmitter.
- When a retractable Proffit assembly made of 1.4571 material is used, the symmetrical high-impedance type of connection must be chosen on the measuring transmitter and an additional connected potential matching.



Note:

Please note the separate operating instructions for the pH measuring transmitter Mycom CPM 151-P and the retractable pH assembly Proffit.

4.4 Connective networking of several systems via Profibus

A maximum of 10 systems, each comprising one control unit CPC 200 and one pneumatic unit CPC 210, can be connected via Profibus.

Shielded twisted-pair bus cable is used for bus system wiring (for properties see table in chapter 9). The bus connectors are installed in the PLC at the factory.

Procedure

- Route and split the bus cable as required.
- Connect the bus cable.
- Enable the terminating resistor on the first and last stations by switching it to the "ON" position.
- Plug in the bus connectors.

Bus cable connection

- Strip the wires according to fig. 4.2.
- Connect the bus cable.
Always connect through
A – A – A ... and
B – B – B ...
- Connect the bare screen to the metal guide.

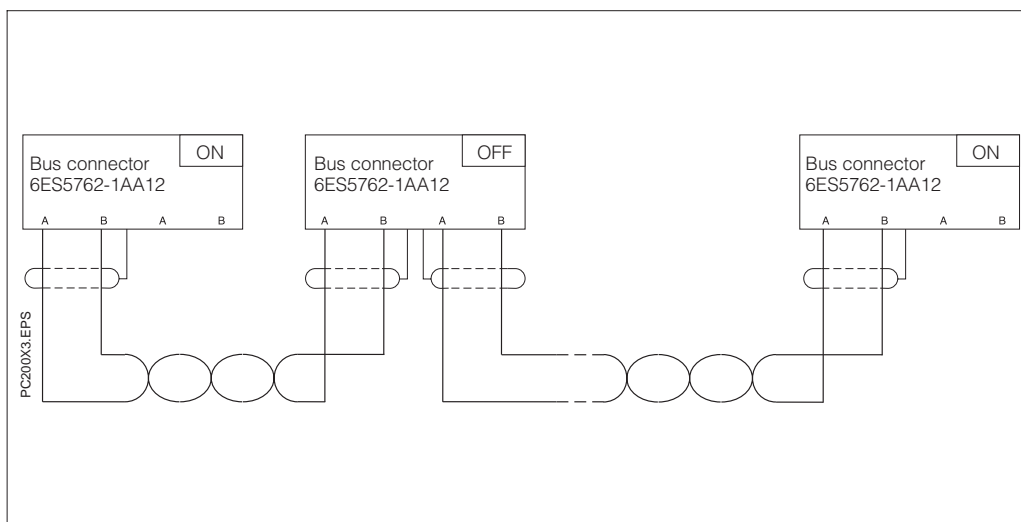


Bild 4.2: Bus cable connection diagram

Fig. 4.3: Bus cable stripping (left)

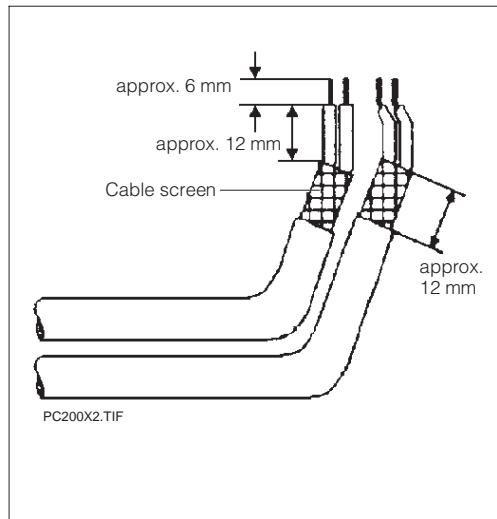
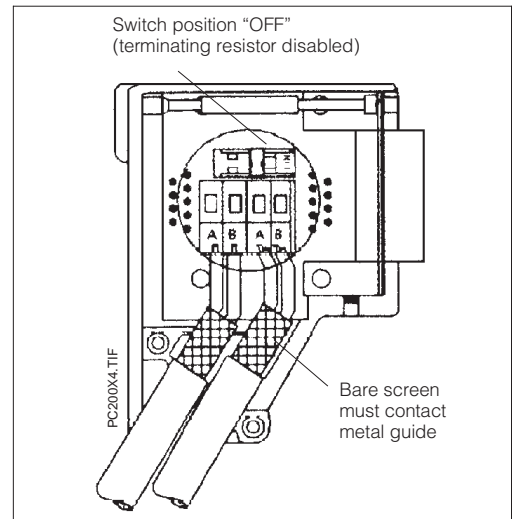


Fig. 4.4: Bus cable connection in opened connector (right)



Note:

Do not twist, stretch or pinch the cables during routing.



Warning:

When routing lines outside buildings, the applicable lightning protection and grounding measures must be taken.

- Lines outside buildings are to be run
 - in metal pipes grounded on both sides, or
 - in concrete armouring
- Signal lines are to be protected against overvoltage by
 - varistors, or
 - inert gas-filled lightning arresters
- Install these protective devices where the cable enters the building.

5. Start-up

5.1 General

**Note:**

- The applicable regulations for safety and accident prevention must be observed.
- Prior to power-up, verify that the mains ratings match the ratings on the nameplate.
- Make sure the media – air and water – are available (stopcocks open).
- The electrode must be installed in the assembly, and the measuring cable must be connected.
- The hoses for air and liquid media must be connected to the assembly.
- The multiple hose coupling in the pneumatic connecting line must be in the “LOCK” position.
- The bottles are filled with the buffer solutions and cleaning agent.
- Switch on the PLC:
The switch must be set to “RUN” (LED RUN is on).

**Warning:**

- Prior to performing installation or repair work, release air and water pressure from system sections.
- Do not perform installation or maintenance work while the system is energised.
- Please be aware that the hoses may contain caustic cleaner solutions.

5.2 Start-up sequence

**Note:**

- The following steps must be taken before starting up the Airtrol.
- Refer to chapter 6 for a detailed listing of the parameter setting steps.
- Refer to the following tables for a listing of the factory settings.

Start-up sequence

Step 1: Settings on Airtrol system			
Set main switch to "ON".		The operating panel goes through a start-up routine. Afterwards, the operating display is shown according to fig. 6.2.	
<p>Note: The version number displayed during the start-up sequence is an internal variable of the operating unit which is independent, however, of the Airtrol version number.</p>			
Step 2: Settings on pH measuring transmitter Mycom CPM 151-P (see chapter 8 of operating instructions for Mycom CPM 151-P)			
Unlocking the start-up level (Matrix field V8 / H9: "Code 2222" + "Enter")			
For measurement and calibration			
Matrix field	Function	Parameter settings	
		Factory	User
V0 / H3	Toggle 0 / 4 ... 20 mA 0 = 0 ... 20 mA 1 = 4 ... 20 mA	1	
V0 / H4	pH at 0 / 4 mA	2.00	
V0 / H6	pH at 20 mA	12.00	
V1 / H3	Determine the temperature compensation: automatic (1 = ATC) or manual (0 = MTC)	1	
V1 / H4	Entry of reference temperature for MTC	25 °C	
V1 / H5	Determine the calibration type: AUTOMATIC (= 1)	1	1
V8 / H3	Toggle the pH input 0 = symmetric 1 = asymmetric (1 for use of assemblies without potential matching pin)	0	
For limit function or control and alarm			
V4 / H0 and V5 / H0	Determine the controller type 0 = controller OFF 1 = limit contacter	1	
V4 / H1 and V5 / H1	Control characteristic for pulse-length or pulse-frequency controller		
V7 / H1	Alarm delay time	30	



Warning:

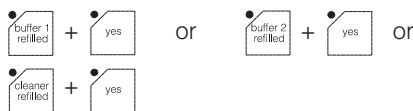
The interface parameters of the pH transmitter must not be modified,

Step 3: Settings via operating panel (main menu: "PASSWORD", "CONFIGURATION")				
Function description	Value range	Parameter settings		Description in chapter:
		Factory	User	
Password – Determination of passwords – level 9 = complete operation and configuration – level 3 = complete operation with calibration and configuration, not, however , password editing, service, Profibus address and clock – level 1 = menu item "language / contrast" of the main menu	levels 1, 3 and 9	2222 1111 (must be entered by Superuser!) —		6.3.8
Buffers – 2 values for buffer solution – upper value – lower value	0.00 to 14.00 pH 0.00 to 14.00 pH	7.00 4.00		6.3.5
Volumes – Volume of bottle with – buffer solution 1 – buffer solution 2 – cleaner solution – Pump delivery volume for – buffer pump 1 – buffer pump 2 – cleaner pump – Typical volumes for the rinse chambers: – Proffit CPA 463 – Proffit CPA 463S – Proffit CPA 465 – 1 m hose with 6 mm inside diameter	0.3 to 20.0 l 0.3 to 20.0 l 0.3 to 20.0 l 10 to 70 ml 10 to 70 ml 10 to 70 ml 30 ml 25 ml 30 ml 13 ml	1.0 1.0 1.0 30 30 30 — — — —		6.3.6



Note:

- When using external buffer and cleaner solution containers, these must not be placed more than 1.5 m below the pneumatic unit CPC 210 in order for the pump to deliver the fluid in question.
- The filling of buffer and cleaner solution bottles must be acknowledged with the following function keys:



Start-up sequence

Step 3: Settings via operating panel				
Function description	Value range	Parameter settings		Description in chapter:
		Factory	User	
Times				6.3.3
– <i>Cleaning</i>				
– stand by time until rinse t0	0 to 999 s	5		
– rinse time t1	0 to 999 s	5		
– soak time for cleaner t2	0 to 999 s	10		
– rinse after cleaner t3	0 to 999 s	5		
– 8 start times	00:00 to 23:59 hours	—		
– weekday	0 = daily 1 to 7 = Mon to Sun	0		
– enable (activation of start time)	0 = OFF, 1 = ON	0		
– <i>HQSS (quick test)</i>				
– 4 start times	00:00 to 23:59 hours	—		
– weekday	0 = daily 1 to 7 = Mon to Sun	0		
– enable	0 = OFF, 1 = ON	0		
– time for measured value stabilization t9	10 to 999 s	30		
– <i>Autocal</i>				
– 4 start times	00:00 to 23:59 hours	—		
– weekday	0 = daily 1 to 7 = Mon to Sun	0		
– enable	0 = OFF, 1 = ON	0		
– <i>Sterilization</i>				
– sterilization time t5	0 to 99 min	0		
– <i>Interval mode</i>				
– stand by time t4	0 to 999 min	10		
– measuring time t6	0 to 999 min	2		
– <i>General</i>				
– air rinse time t7 (blowing out of pH measuring chamber; for HQSS and autocal)	5 to 999 s	5		
– time for external cleaning t8 (for cleaning, HQSS and autocal)	0 to 999 s	0		
– rinse time after buffer t10 (for HQSS and autocal)	1 to 999 s	1		
– current output delay time t11 (When the pH assembly has returned to the measuring position after HQSS or autocal, the current output stays on “HOLD” for the duration of the delay time.)	1 to 999 s	1		

Step 3: Settings via operating panel				
Function description	Value range	Parameter settings		Description in chapter:
		Factory	User	
Limits				6.3.2
– <i>Alarm</i>				
– pH: upper limit	0.00 to 14.00 pH	10.00		
– pH: lower limit	0.00 to 14.00 pH	2.00		
– temp.: upper limit	–15.0 to +150.0 °C	50.0		
– temp.: lower limit	–15.0 to +150.0 °C	0.0		
– <i>Calibration</i>				
– slope: upper level	65.0 to 110.0%	110.0		
– slope: lower level	65.0 to 110.0%	65.0		
– zero point: upper level	5.50 to 9.50 pH	9.50		
– zero point: lower level	5.50 to 9.50 pH	5.50		
– <i>2 pH windows for HQSS</i>				
– window 1: upper limit	0.00 to 14.00 pH	7.50		
– window 1: lower limit	0.00 to 14.00 pH	6.50		
– window 2: upper limit	0.00 to 14.00 pH	4.50		
– window 2: lower limit	0.00 to 14.00 pH	3.50		
Cleaning				6.3.4
– Number of cleaning cycles for cleaning, HQSS and autocal	1 to 9	1		
– Toggle between internal and external cleaning system ¹	0 = internal 1 = external	0		
– Switch on back-pressure water ²	0 = OFF, 1 = ON	0		
PLC clock				6.3.7
– Date	01.01.00 to 31.12.99	—		
– Time	00:00 to 23:59 hours	—		
– Weekday	1 to 7 = Mon to Sun	—		











Remark:**¹ Toggle cleaning system**

0 = Internal cleaning system
1 = External cleaning system

² Switch on back-pressure water

When the pH electrode is retracted or moved into the process, a short-time overlap between process and outlet occurs with some retractable assemblies, e. g. Probit CPA 463. To prevent intrusion of fibrous or abrasive media into the seal and rinse area of the assembly, back-pressure water can be switched on when the assembly is retracted or moved into the process. An additional outlet valve (accessory for the assembly) ensures that the back-pressure does not escape through the outlet.
Note:
The back-pressure must exceed the process pressure.

Start-up sequence

Step 4: Functional test	
Selection of "manual" mode	Press the  function key and follow the directions on the display.
Switching to enlarged display	Press the  function key.
Priming / checking of hoses	<ul style="list-style-type: none"> – Press the  function key until the buffer value is shown on the display. – Press the  function key for 3 seconds. <p>The calibration chamber is blown out.</p> <p>Repeat these steps for buffer 2 and cleaner.</p>
Water valve test	Press the  function key in the "manual" mode.
Return to normal display	Press the  function key twice.
Selection of "automatic" mode	<p>Press the  function key.</p> <p>The pH electrode moves to measuring position.</p> <p>Follow the function sequence by observing the operating panel display.</p>
Manual start of a cleaning cycle	<p>Press the  function key.</p> <p>Follow the function sequence by observing the operating panel display.</p> <p>When the cycle is complete, the electrode returns to the measuring position.</p>
Manual start of an HQSS cycle	<p>Press the  function key.</p> <p>Follow the function sequence by observing the operating panel display.</p> <p>When the cycle is complete, the electrode returns to the measuring position.</p>
Manual start of an autocal cycle	<p>Press the  function key.</p> <p>Follow the function sequence by observing the operating panel display.</p> <p>When the cycle is complete, the electrode returns to the measuring position.</p>

6. Operation

The operating panel for communication between the Airtrol and the operator consists of a display and a keypad.

Display

The display can show 8 lines of 40 characters each. The display is backlit. The contrast can be adjusted to the ambient lighting conditions. There are two possibilities to proceed:

- By the “Shift” and “+/-” keys
 - Press the “Shift” key (it switches into the contrast mode)
 - Adjust contrast by the “+/-” key
 - Press the “Shift” key again
- In the menu item “language / contrast” of the main menu (see chapter 6.2).

The indications in the upper left corner of the display have the following meanings:

AUTO	automatic mode of operation
MAN	manual mode of operation
CLEAN	cleaning
HQSS	High Quality Sensor check System
ACAL	autocal
I	interval mode
S	back-pressure water
H	HOLD



Note:

- The contrast may change within one hour of power-up.
- The keys are active when the corresponding LED flashes.

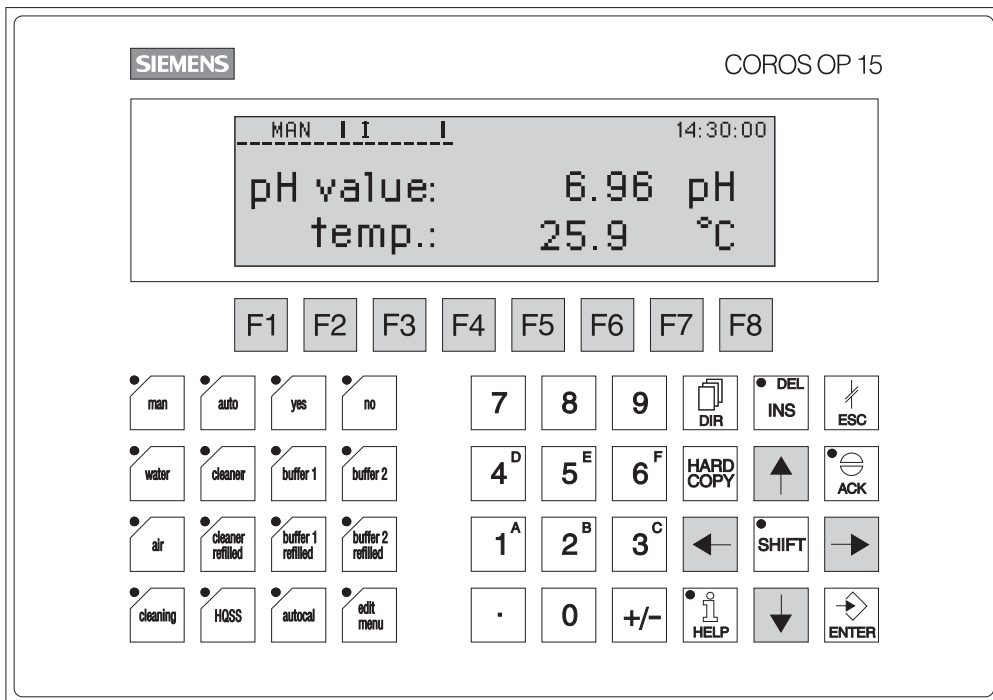


Fig. 6.1: Airtrol operating panel with display indication after start-up

Note:

The LEDs of the function keys (left key block) beam depending on the current program step, not, however, the LEDs of the function keys

- “cleaner refilled”
- “buffer 1 refilled”
- “buffer 2 refilled”

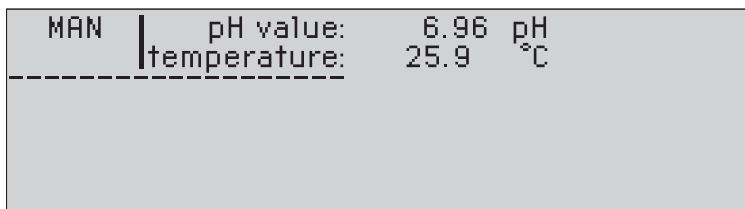


Fig. 6.2: Airtrol normal display indication

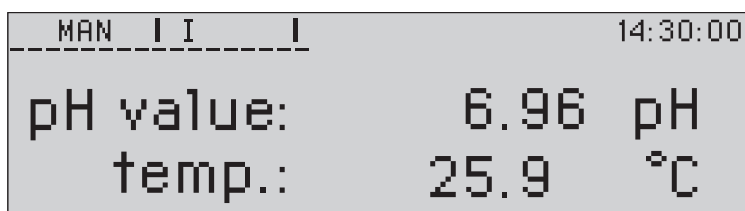




Fig. 6.3: Airtrol enlarged display indication (see chapter 6.2)


Menu function keys


 Manual mode, i. e. automatic mode is interrupted and the assembly moves to service position.


 Automatic mode, i. e. the assembly is in measuring position.


 Confirm


 Cancel


 Opens the water valve for as long as the key is pressed (key is enabled in "manual" mode only).

 Activates the cleaner pump or the external cleaning system for as long as the key is pressed (key is enabled in "manual" mode only).

 Activates buffer pump 1 for as long as the key is pressed (key is enabled in "manual" mode only).


 Activates buffer pump 2 for as long as the key is pressed (key is enabled in "manual" mode only).

 Opens the rinse air valve for as long as the key is pressed (key is enabled in "manual" mode only).
The cleaning / calibration chamber in the retractable assembly can be blown out with air.

 Sets the level monitoring for cleaner to starting value.


Note:

This key must be pressed after refilling (replacing) an empty cleaner bottle.

 Sets the level monitoring for "buffer 1" to starting value.


Note:


This key must be pressed after refilling (replacing) an empty buffer bottle.


 Sets the level monitoring for "buffer 2" to starting value.


Note:

This key must be pressed after refilling (replacing) an empty buffer bottle.

 Starts the cleaning cycle.

 Starts the quick sensor check (HQSS).

 Starts the automatic calibration.


 Switches to the main menu.




Note:


The main menu is only selectable if all error messages are cleared (see chapter 7).


System keypad

 No function


 Delete / insert


 Backspace key


 No function


 Cursor key "up"; accesses previous menu item.

 Cursor key "left"


 Cursor key "right"


 Cursor key "down"; accesses next menu item.

 Used to acknowledge error messages.

 Function keys for contrast adjustment of operator panel display



 Activates info texts.

 Acknowledge key

6.1 Modes of operation

The operation of the Airtrol is menu-driven. Two modes of operation are available:

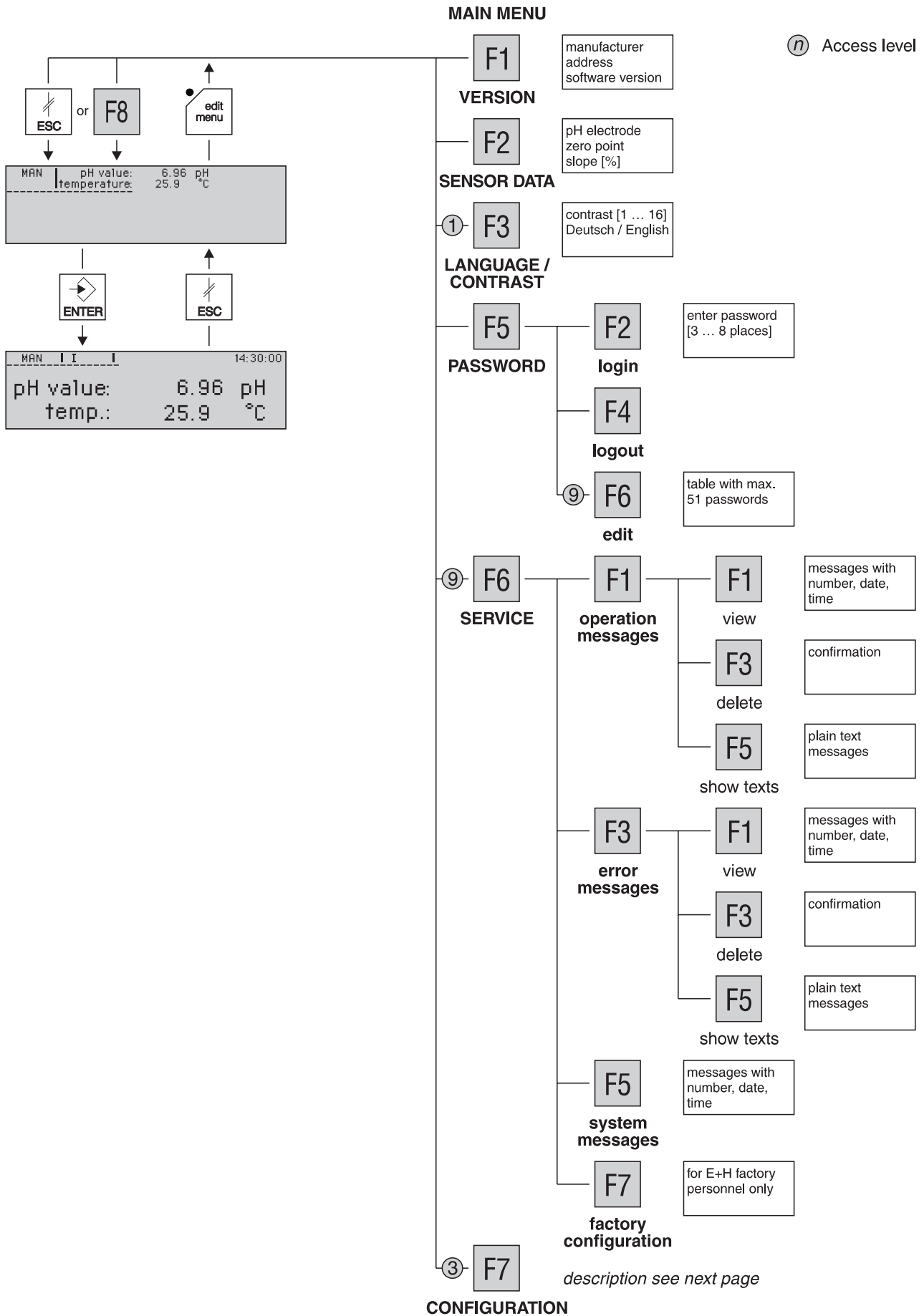
- **“Man(ual)”** mode of operation, i. e. operation via the operating panel.
 - The retractable assembly is in service position.
- **“Auto(matic)”** mode of operation, controlled via real-time clock, contact inputs or L2 bus (Profibus).
 - The retractable assembly is in measuring position.

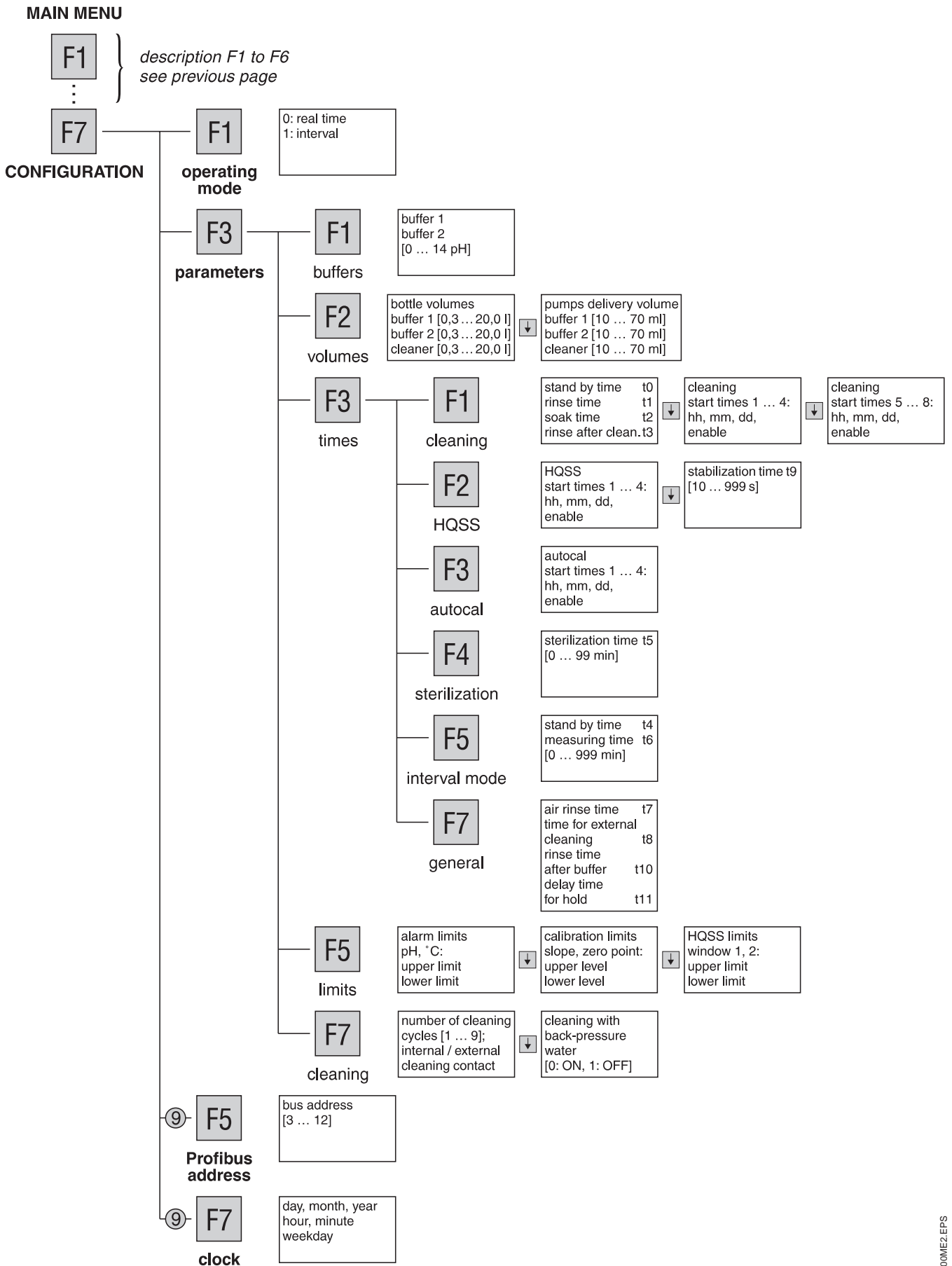
The mode of operation is indicated in the upper left corner of the normal or enlarged display by “MAN” or “AUTO” (see figs. 6.2 and 6.3).

The parameters for the control unit Airtrol CPC 200 are set via the operating panel.


The parameters for the pH measurement integrated in the system are set directly on the Mycom CPM 151-P pH measuring transmitter located in the control unit Airtrol CPC 200.

6.2 Airtrol menu structure





6.3 Single menus

The main menu is accessed by the  key.

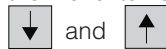
The single menus are selected by the softkeys:



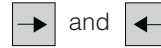
Note:

The configuration menu is only selectable if all error messages are cleared (see chapter 7).


The following cursor keys are used to select the menu items:



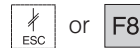
To change the value of a menu item, select the desired digit by moving the cursor with one of the following cursor keys:



A value may be changed using the numeric keypad. A flashing value indicates that this is the value that will be overwritten.

Any entry made must be confirmed by pressing the  key.

To return to the next menu level above, press



6.3.1 Password entry

The password serves to protect the entire system.

Access code

The access code for different user groups is defined via the password menu.

The basic access code and level structure is as follows:

The codes for access levels 1, 3 and 9 are user-definable. The Superuser password mentioned is the factory default password stored in the system. It can be replaced by user codes.

For safety reasons, you should make a note of your password and keep it in a safe place in order to prevent system access by unauthorised persons.

Access level	Designation	Password	Access for
1	Operator in field	e. g. 3333	Menu item "language / contrast" of the main menu
3	Operator in field	e. g. 1111	Complete operation with calibration and configuration (display only), not, however, password editing, service, Profibus address and clock
9	Superuser	2222	All functions, i. e. complete operation and configuration



Note:

- The access levels 2 and 4 to 8 are not defined in the control, i. e. they are without further functions. For example, level 4 can execute the same functions as level 3.

- Factory default setting for the password is "2222". To change the password refer to chapter 6.3.8.

Login


The following steps are required for password entry:

- Press 

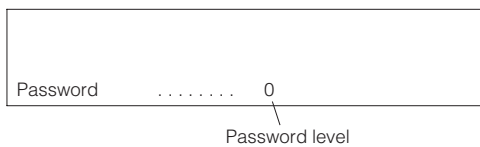
You are in the main menu.

- Press 

You are in the password menu.

- Press  for login.

The "password" entry field opens.



Password, 0
Password level

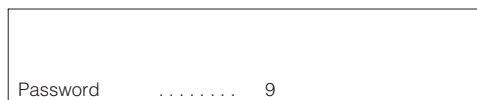
- Enter your password, e. g. "9999", via the numeric keypad.




Password *****

- Press 

The access level corresponding to the password you have just entered is indicated (the example shows the Superuser level 9).



Password 9

- Press  to return to the starting point.

6.3.2 Limit settings

(detailed representation)

You are in the main menu and have already entered your password.

- Press **F7**

You are in the configuration menu.

- Press **F3**

You are in the parameter menu.

- Press **F5**

The menu item "alarm limits" is displayed, where you can enter the upper and lower limits for pH (0 to 14 pH) and temperature (-15 to +150 °C). The cursor flashes in the "upper limit pH" entry field.

ALARM LIMITS		
upper limit	pH :	pH
lower limit	pH :	pH
upper limit	temp. :	°C
lower limit	temp. :	°C

- Enter the new value via the numeric keypad. The entire value now flashes.

- Press 


The new value is accepted and ceases to flash.

- Use the same procedure to enter "lower limit pH", "upper limit temp." and "lower limit temp."

- Press 

This takes you to the menu item "calibration limits", where you can enter the upper and lower levels for slope (65 to 110% of the theoretical slope) and zero point (5.50 to 9.50 pH).


CALIBRATION LIMITS		
slope:	upper level :	%
	lower level :	%
zero point:	upper level :	pH
	lower level :	pH

- Enter the values and confirm them by 

- Press 

This takes you to the menu item "HQSS limits", where you can enter the upper and lower limits for the HQSS windows 1 and 2 (0.00 to 14.00 pH).

HQSS LIMITS		
window 1:	upper limit :	pH
	lower limit :	pH
window 2:	upper limit :	pH
	lower limit :	pH

- When you finished entering parameters, press  to return to the starting point.



Note:

The limits entered via the operating panel only affect relay 7K3 as a common signal. Further limits can be entered separately on the Mycom. However, exceedings of these values also affect 7K3 (see Mycom operating instructions).

6.3.3 Time settings

You are in the main menu and have already entered your password.

- Press **F7**

You are in the configuration menu.

- Press **F3**

You are in the parameter menu.

- Press **F3** again.

You are in the time menu.



Cleaning

- Press **F1**

You can now enter all times for cleaning. The first menu item is "general times for cleaning".

GENERAL TIMES FOR CLEANING			
stand by time until rinse: t0		sec.	
rinse time: t1		sec.	
soak time for cleaner: t2		sec.	
rinse after cleaner: t3		sec.	


Entry range for t0 to t3: 0 to 999 s.

- Enter the times and confirm them by 
- Press 


In the menu items "start cleaning 1...4" and "start cleaning 5...8" you can enter a maximum of altogether 8 start times to start the cleaning cycle. These start times are controlled by the built-in real-time clock and can be used for daily cleaning or cleaning on a specific weekday.

START CLEANING 1...4			
clean. 1: hh	mm	dd	enable
clean. 2: hh	mm	dd	enable
clean. 3: hh	mm	dd	enable
clean. 4: hh	mm	dd	enable

START CLEANING 5...8			
clean. 5: hh	mm	dd	enable
clean. 6: hh	mm	dd	enable
clean. 7: hh	mm	dd	enable
clean. 8: hh	mm	dd	enable

- Use the cursor keys to move between the entry fields. Confirm your settings by 

The settings become active after entering "1" in the "enable" field.

- When you finished entering parameters, press  to return to the starting point.

HQSS

The HQSS "High Quality Sensor check System" is used to check the pH electrode quickly by means of the two buffer solutions.

The HQSS check tests whether the pH electrode reaches a specific pH window within a given period of time when pH buffer solution is supplied. This check does not constitute a calibration of the pH electrode. It has the following advantages:

- The current calibration remains unchanged.
- The pH electrode is checked very quickly.

You are in the time menu.

- Press **F2**

In the menu item "start HQSS 1...4" you can enter 4 start times for the HQSS check. These start times can be assigned to every weekday (daily) or to a specific weekday.


START HQSS 1...4			
HQSS 1: hh	mm	dd	enable
HQSS 2: hh	mm	dd	enable
HQSS 3: hh	mm	dd	enable
HQSS 4: hh	mm	dd	enable

- Proceed as above to set, confirm and activate the start times.

- Press 

In the menu item "other times HQSS" you can enter the time for stabilization of the measured value.

OTHER TIMES HQSS	
Stabilization time :	sec.
entry range: 10-999 sec.	

- When you finished entering parameters, press  to return to the starting point.


Autocal

You are in the time menu.

- Press **F3**

You can enter 4 start times to start the autocal cycle. These cycles can be either repeated daily or on a specific weekday.

START AUTOCAL 1...4			
AutoCal 1:	hh	mm	dd enable
AutoCal 2:	hh	mm	dd enable
AutoCal 3:	hh	mm	dd enable
AutoCal 4:	hh	mm	dd enable

- Proceed as above to set, confirm and activate the start times.
- Press  to return to the starting point.



Note for cleaning, HQSS and autocal:

If the current output or controller of the pH instrument is used, then it is automatically set to "HOLD" with the above functions.

After completion of the function, "HOLD" is automatically reset after the delay time for hold entered in "general times".

Sterilization


In the rinse chamber, the electrode comes into contact with non-sterile air, water or buffer solution. Therefore a step "sterilization" is provided.

You are in the time menu.

- Press **F4**

You can enter the sterilization time. Setting "0" means that relay contact 7K5 is not actuated and no sterilization takes place. If you enter a time > 0, then sterilization will be performed after each cleaning, HQSS or autocal process before the sensor moves back to service position. This occurs regardless whether cleaning, HQSS or autocal was started manually, automatically or externally.

STERILIZATION	
entry:	t5 min.
0 = no sterilization	
entry range: 0-99 min.	

- Press  to return to the starting point.

Interval mode


You are in the time menu, and the interval mode is selected (see chapter 6.5). In the real-time mode, the menu item "interval mode" is not relevant.

- Press **F5**

You can enter the times for the interval mode.

- Stand by time:
The assembly is in service position.
- Measuring time:
The assembly is in measuring position.

TIMES FOR INTERVAL MODE	
stand by time:	t4 min.
measuring time:	t6 min.
entry range: 0 - 999 min.	
Real time ==> not relevant !	

- Press  to return to the starting point.

General

You are in the time menu.

- Press **F7**


You can enter the following general times.

- Time for air rinse (blowing out of the pH measuring chamber) for HQSS and autocal
- Cleaning time for an external cleaning system for cleaning, HQSS and autocal (relay contact 7K4)
- Water rinse time after buffer for HQSS and autocal
- Current output delay time:
When the pH assembly has returned to the measuring position after HQSS and autocal, the current output stays on "HOLD" for the duration of the delay time.

GENERAL TIMES	
air rinse time:	t7 sec.
time for external cleaning:	t8 sec.
rinse time after buffer:	t10 sec.
delay time for hold:	t11 sec.

Entry range for

- t7: 5 to 999 s
- t8: 0 to 999 s
- t10, t11: 1 to 999 s.

- Press  to return to the starting point.

6.3.4 Cleaning settings

You are in the main menu and have already entered your password.

- Press **F7**

You are in the configuration menu.



- Press **F3**

You are in the parameter menu.

- Press **F7**

In the menu item “cleaning cycles” you can enter the number of cycles for cleaning and switch the cleaner pump to “internal” or “external”.

CLEANING CYCLES	
cleaning cycles :	1-9
cleaning int./external:	0=intern. 1=extern.

- Enter the values and confirm them by 
- Press 



In the menu item “cleaning with back-pressure water” you can switch on back-pressure water:

When the pH electrode is retracted or moved into the process, a short-time overlap between process and outlet occurs with some retractable assemblies, e. g. Probit CPA 463. To prevent intrusion of fibrous or abrasive media into the seal and rinse area of the assembly, back-pressure water can be switched on when the assembly is retracted or moved into the process. An additional outlet valve (accessory for the assembly) ensures that the back-pressure does not escape through the outlet.

Note:

The back-pressure must exceed the process pressure.

CLEANING WITH BACK-PRESSURE WATER	
entry:	
	1=with back-pressure water

- Enter the value and confirm it by 
- Press  to return to the parameter menu.

6.3.5 Buffer settings

You are in the main menu and have already entered your password.

- Press **F7**

You are in the configuration menu.



- Press **F3**

You are in the parameter menu.

- Press **F1**

You can enter the pH values of the buffers.

BUFFER VALUE ENTRY	
buffer solution 1:	pH
buffer solution 2:	pH
entry range: 0.00 – 14.00 pH	

- Enter the values and confirm them by 
- Press  to return to the parameter menu.

6.3.6 Volume settings

You are in the main menu and have already entered your password.

- Press **F7**

You are in the configuration menu.


- Press **F3**

You are in the parameter menu.

- Press **F2**

In the menu item “bottle volumes” you can enter the total volumes of the bottles for buffer solutions and cleaner.

BOTTLE VOLUMES	
buffer solution 1 :	
buffer solution 2 :	
cleaner :	
entry range: 0.3 – 20.0 l	

- Enter the values and confirm them by 

- Press 


In the menu item “pumps delivery volume” you can enter the delivery volumes for buffer pumps and cleaner pump.

PUMPS DELIVERY VOLUME	
buffer pump 1:	ml
buffer pump 2:	ml
cleaner pump :	ml
entry range: 10 – 70 ml	



Note:

The delivery volume depends on the retractable assembly used. The calibration chamber must always be filled completely. Please note the operating instructions supplied with the Proffit assembly.

- Enter the values and confirm them by 

- Press  to return to the starting point.

6.3.7 Clock settings

You are in the main menu and have already entered the Superuser password.


- Press **F7**


You are in the configuration menu.

- Press **F7** again.

You can enter date, time and weekday (1 to 7 = Monday to Sunday) for the PLC.

SHOW/SET TIME+DATE		
day:	month:	year:
hour:	minute:	weekday:

- Enter the values and confirm them by 

- Press  to close this menu.

Date and time are automatically transferred when you close the menu (seconds are set to zero).

6.3.8 Password settings

The password menu is used for login, logout and password editing.

You are in the main menu.

- Press **F5**

You are in the password menu.

- Press **F6**

If you have not yet entered the Superuser password, then the following message is displayed:

```
$ 317: Password level invalid
```

This is followed by:

```
Password ..... 0
```

- Enter the Superuser password via the numeric keypad.

```
Password *****
```

- Press 

The Superuser level 9 is indicated.

```
Password ..... 9
```

- Press 

- Press **F6**

You can edit a table of max. 51 passwords. The cursor flashes on the entry level of the first password.

```
0          2 2 2 2  9
1  - - - - - - - -
2  - - - - - - - -
.  - - - - - - - -
.  - - - - - - - -
9  - - - - - - - -
.  - - - - - - - -
50 - - - - - - - -
```

- Enter your desired password, e. g. "1111" for level 3, via the numeric keypad.

```
0          2 2 2 2  9
1          1 1 1 1  -
2  - - - - - - - -
.  - - - - - - - -
.  - - - - - - - -
9  - - - - - - - -
.  - - - - - - - -
50 - - - - - - - -
```

- Press 

- Press  to select the "level" entry field.

- Enter "3" via the numeric keypad.

```
0          2 2 2 2  9
1          1 1 1 1  3
2  - - - - - - - -
.  - - - - - - - -
.  - - - - - - - -
9  - - - - - - - -
.  - - - - - - - -
50 - - - - - - - -
```

- Proceed in the same manner for level 9, i. e. overwrite "2222".

 **Note:**

- A password is necessary for levels 1, 3 and 9.
- The password is deleted by entering "0".

See also chapters 5.2 and 6.3.1.

6.4 Service

You are in the main menu and have already entered the Superuser password.

- Press **F6**

You are in the service menu.

6.4.1 Operation and error messages

The submenus “operation messages” and “error messages”, which you can enter

by pressing **F1** or **F3**, respectively,

have the same structure (see chapter 6.2). The following table describes the functions of their menu items.

Function description	Meaning
F1 View	<ul style="list-style-type: none"> – Lists all operation or error messages with number and with date and time of occurrence. – For troubleshooting, refer to chapter 7, “Error diagnosis”.
F3 Delete	<ul style="list-style-type: none"> – After confirmation, this erases all messages contained in the operation or error message buffer with the exception of any alarms that have not been cleared.
F5 Show texts	<ul style="list-style-type: none"> – Lists all operation or error message numbers with the corresponding plain text messages.

Legend:

Ack-Gr/ = Acknowledging group for error messages (not used at the moment)

No 00/ = Acknowledging group number
014 = Message number

C = came
G = gone
A = acknowledged

on 25.03.95 = date
23:29:25 = time

Example of an operation message

Event no 059 C on 16.02.95 23:29:25
Event no 059 G on 16.02.95 23:29:35
Event no 059 A on 16.02.95 23:29:45

Example of an error message

Ack-Gr/No 00/014 C on 25.03.95 23:29:25
Ack-Gr/No 00/014 G on 25.03.95 23:29:35
Ack-Gr/No 00/014 A on 25.03.95 23:29:45

6.4.2 System messages

You are in the service menu.

- Press **F5**

Analogously to the menu items “view” described in the previous chapter, system messages with number, date and time are listed.


6.4.3 Factory configuration



Warning:

This menu item is reserved for use by Endress+Hauser factory personnel exclusively.

6.5 “Auto(matic)” mode of operation

Normal measuring operation takes place in the “auto(matic)” mode of operation and is started by pressing the  key on the operating panel.

If there is no manual intervention (“man(ual)” mode of operation), the system continues to operate until interrupted by a cleaning or other procedure started.

Interruptions may be:

- cleaning
- HQSS
- autocal
- via the timer programmed
- via the L2 bus
- via external contact inputs

Real time mode and interval mode

In the menu item “operating mode” of the configuration menu (see chapter 6.2), two modes of operation can be selected.

- Real-time mode (setting “0”):
The assembly is in measuring position, only in service position for cleaning and calibration.
- Interval mode (setting “1”):
The assembly is in service position during stand by time t4, only in measuring position during measuring time t6 according to the setting of the timer (see chapter 6.3.3).
The value of t6 appears in the upper right corner of the normal display.

6.5.1 Measuring mode (“Auto(matic)”)

After powering up the Airtrol by switching on the main switch (see fig. 3.1), the system performs a start routine including an EEPROM test, RAM test and flash test.

- If the electrode is in measuring position, the display indicates the “auto(matic)” mode:

AUTO	pH value:	6.96 pH
	temperature:	25.9 °C

- If the electrode is in service position, the display indicates the “man(ual)” mode:

MAN	pH value:	6.96 pH
	temperature:	25.9 °C



Note:

All function keys with flashing LEDs can be used.

6.5.2 Cleaning function

There are 4 possibilities to start a cleaning cycle:

- via timer
- via L2 bus
- via keyboard (for maintenance in the field)
- externally via the contact input "start cleaning" (terminal 4/5, see fig. 4.1).

You can enter 8 start times. These are assigned to every weekday or to a specific weekday. Each cleaning start time must be enabled separately to become active.

Increasing the number of cleaning cycles is possible by means of a programmable repeat sequence via the menu item "cleaning" of the parameter menu (see chapter 6.3.4).

"External" cleaning

If required, the Airtrol can also be used to drive an external cleaning system (relay contact 7K4).

To do this, the menu item "cleaning" of the parameter menu must be programmed for "cleaning external" (see chapter 6.3.4).

The internal pump is disabled when external cleaning is selected.

Cleaning

Refer to chapter 6.3.3 with regard to parameter entry for the cleaning procedure.

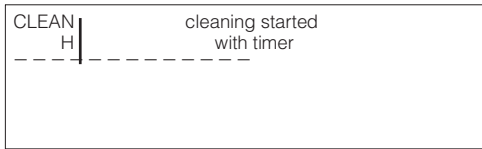
The control diagram is shown in the following.

Control diagram "cleaning"													
Action	Measuring	Set Hold	Retract electrode	Waiting	Pre rinse	Pump cleaning agent	Soaking	Water rinse	Standby*	Sterilization	Electrode to medium	Hold delay	Measuring
Parameter				t0	t1	vol.2	t2	t3	(t4)	t5		t11	(t6)
Service position													
Measuring position													
Hold													
Water													
Cleaning agent													
Compressed air													
Buffer 1													
Buffer 2													
Sterilization													
Back-pressure water													
Repeated cleaning													

*for interval mode only

The individual steps of a cleaning cycle started with timer are:

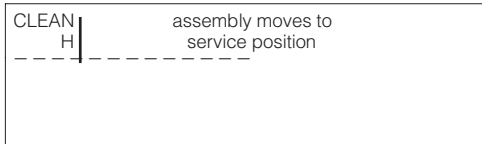
Step 1: **Cleaning started with timer**



Note:

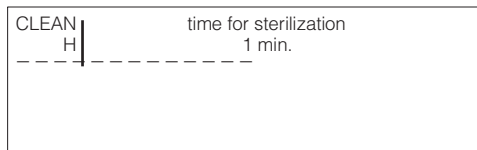
If the “cleaning” start input is enabled by remote control at this time, then the assembly remains in service position after water rinse until the start input is opened again.

Step 2: **Assembly moves to service position**

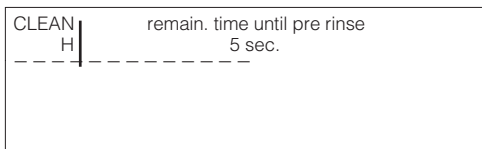


The following step is only performed if a sterilization time $t_5 > 0$ was set.

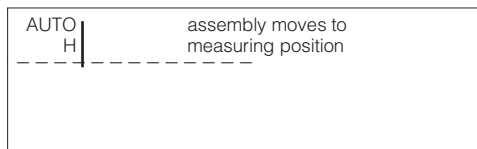
Additional step: **Sterilization**



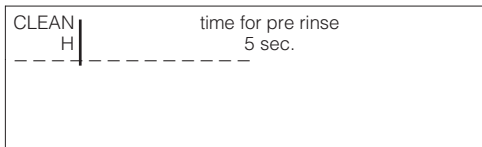
Step 3: **Pause**



Step 8: **Assembly moves to measuring position**



Step 4: **Water valve is open**



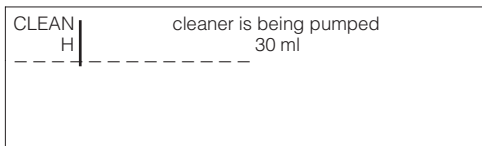
The cleaning procedure is now complete. Normal operation continues.



Note:

If a problem is detected during the sequence, then a changed sequence will be performed, which you can easily follow on the operating panel. The corresponding error number (Err) appears on the display. See chapter 7.1 for error explanations and troubleshooting instructions.

Step 5: **Cleaning**



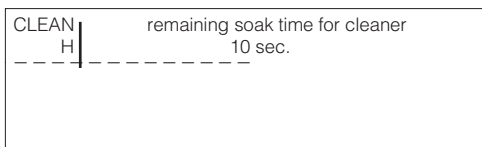
Note

for cleaning, HQSS and autocal:

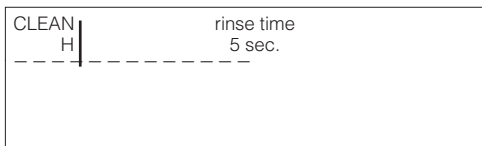


A cleaning, HQSS or autocal cycle can be truncated by

Step 6: **Soaking**



Step 7: **Water valve is open**



6.5.3 HQSS function

The HQSS “High Quality Sensor check System” mode permits the pH electrode to be checked using the two buffer solutions.

The HQSS check verifies whether or not the pH electrode reaches a specific pH window within a given period of time. This check does not constitute a calibration of the pH electrode.

Advantages of HQSS check

- The current calibration remains unchanged.
- The pH electrode is checked very quickly.

There are 4 possibilities to start an HQSS cycle:

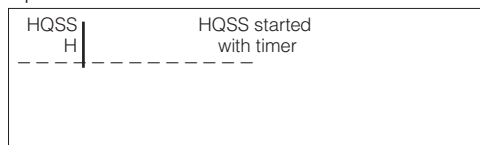
- via timer
- via L2 bus
- via keyboard (for maintenance in the field)
- externally via the contact input “start HQSS” (terminal 4/6, see fig. 4.1).

You can enter 4 start times. These are assigned to every weekday or to a specific weekday. Each HQSS start time must be enabled separately to become active. The control diagram is shown in the following.

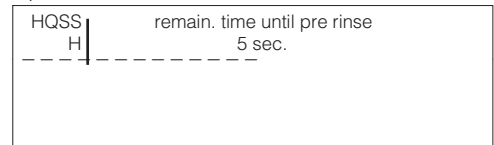
Control diagram “HQSS”																					
Action	Measuring	Set Hold	Retract electrode	Waiting	Pre rinse	Pump cleaning agent	Soaking	Water rinse	Air rinse	Pump buffer 1	Set point comparison 1	Water rinse	Air rinse	Pump buffer 2	Set point comparison 2	Water rinse	Sterilization	Electrode to medium	Hold delay	Measuring	
Parameter				t0	t1	vol.2	t2	t3	t7	vol.	t9	t10	t7	vol.	t9	t10	t5		t11		
Service position																					
Meas. position																					
Hold																					
Water																					
Cleaning agent																					
Compressed air																					
Buffer 1																					
Buffer 2																					
Sterilization																					
Back-press. water																					
Repeated clean.																					

The individual steps of an HQSS cycle started with timer are:

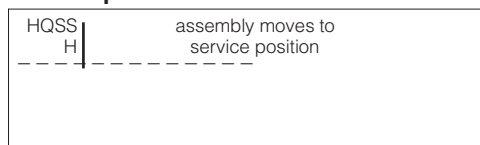
Step 1: **HQSS started with timer**



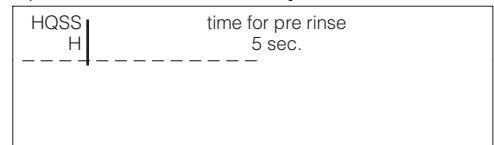
Step 3: **Pause**



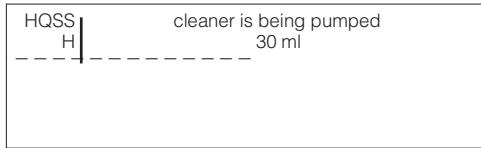
Step 2: **Assembly moves to service position**



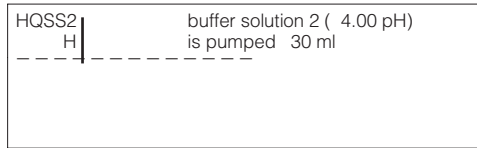
Step 4: **Water valve is open**



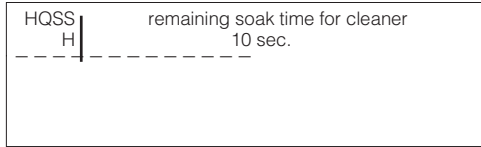
Step 5: **Cleaning**



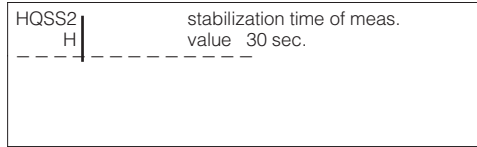
Step 14: **Buffer 2 is pumped**



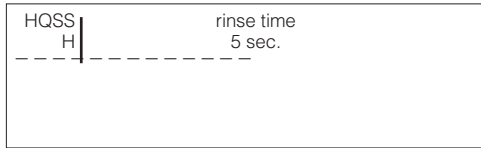
Step 6: **Soaking**



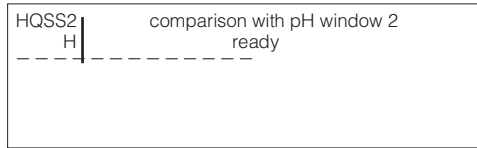
Step 15: **Pause**



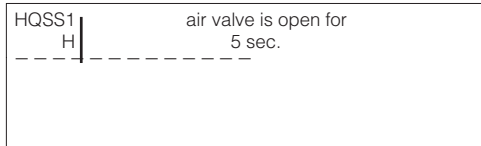
Step 7: **Water valve is open**



Step 16: **Comparison with window 2**



Step 8: **Air valve is open**



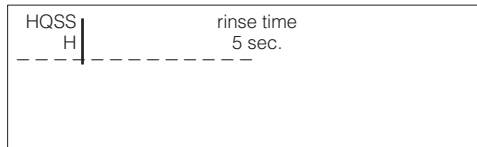
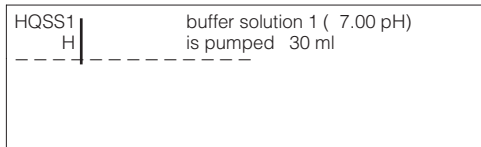
Step 17: **Water valve is open**

Note:

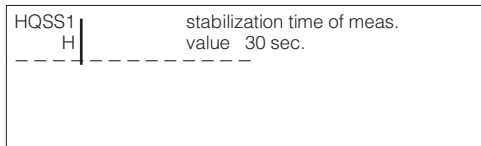


If the "HQSS" start input is enabled by remote control at this time, then the assembly remains in service position after water rinse until the start input is opened again.

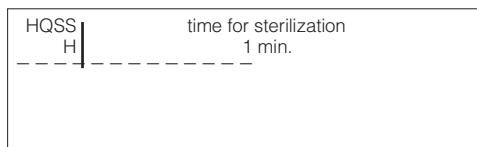
Step 9: **Buffer 1 is pumped**



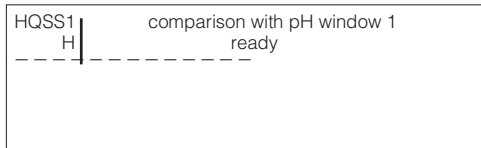
Step 10: **Pause**



Additional step for t5 > 0: **Sterilization**

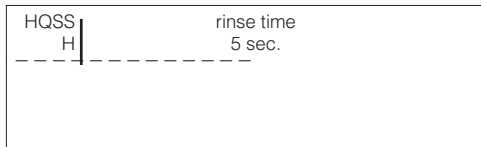


Step 11: **Comparison with window 1**



The HQSS procedure is now complete. The assembly returns to the measuring position. Normal operation continues.

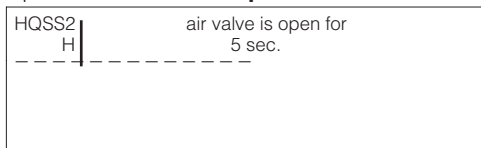
Step 12: **Water valve is open**



Note:

If a problem is detected during the sequence, then a changed sequence will be performed, which you can easily follow on the operating panel. The corresponding error number (Err) appears on the display. See chapter 7.1 for error explanations and troubleshooting instructions.

Step 13: **Air valve is open**



6.5.4 Autocal function

(Automatic calibration)

There are 4 possibilities to start an autocal cycle:

- via timer
- via L2 bus
- via keyboard (for maintenance in the field)
- externally via the contact input "start autocal" (terminal 4/7, see fig. 4.1).

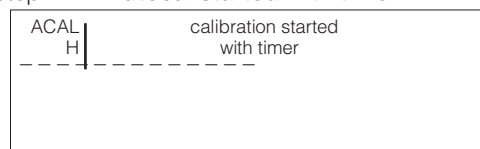
You can enter 4 start times. These are assigned to every weekday or to a specific weekday. Each autocal start time must be enabled separately to become active.

The control diagram is shown in the following.

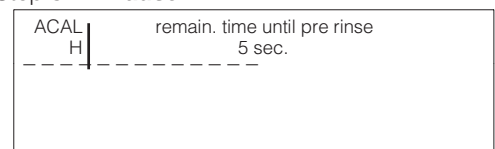
Control diagram "autocal"																					
Action	Measuring	Set Hold	Retract electrode	Waiting	Pre rinse	Pump cleaning agent	Soaking	Water rinse	Air rinse	Pump buffer 1	Calibrate value 1	Water rinse	Air rinse	Pump buffer 2	Calibrate value 2	Water rinse	Sterilization	Electrode to medium	Hold delay	Measuring	
Parameter				t0	t1	vol.2	t2	t3	t7	vol.		t10	t7	vol.		t10	t5		t11		
Service position																					
Meas. position																					
Hold																					
Water																					
Cleaning agent																					
Compressed air																					
Buffer 1																					
Buffer 2																					
Sterilization																					
Back-press. water																					
Repeated clean.																					

The individual steps of an autocal cycle started with timer are:

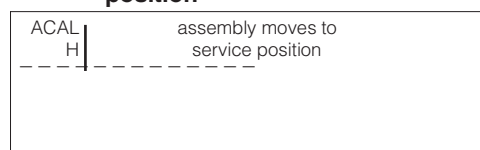
Step 1: **Autocal started with timer**



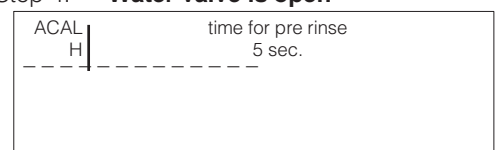
Step 3: **Pause**



Step 2: **Assembly moves to service position**



Step 4: **Water valve is open**



Step 5: **Cleaning**

ACAL	cleaner is being pumped
H	30 ml

Step 14: **Buffer 2 is pumped**

ACAL2	buffer solution 2 (4.00 pH)
H	is pumped 30 ml

Step 6: **Soaking**

ACAL	remaining soak time for cleaner
H	10 sec.

Step 15: **Calibration 2 started**

ACAL2	cal. with buffer sol. (4.00 pH)
H	started

Step 7: **Water valve is open**

ACAL	rinse time
H	5 sec.

Step 16: **Calibration 2 completed**

ACAL2	calib. with buffer sol. 2
H	ready

Step 8: **Air valve is open**

ACAL1	air valve is open for
H	5 sec.

Step 17: **Display of calibration data**

ACAL	sensor	zero point:	pH
H	data	slope:	%

Step 9: **Buffer 1 is pumped**

ACAL1	buffer solution 1 (7.00 pH)
H	is pumped 30 ml

Step 18: **Water valve is open**

ACAL	rinse time
H	5 sec.

Step 10: **Calibration 1 started**

ACAL1	cal. with buffer sol. (7.00 pH)
H	started

Note:



If the "autocal" start input is enabled by remote control at this time, then the assembly remains in service position after water rinse until the start input is opened again.

Step 11: **Calibration 1 completed**

ACAL1	calib. with buffer sol. 1
H	ready

Additional step for t5 > 0: **Sterilization**

ACAL	time for sterilization
H	1 min.

Step 12: **Water valve is open**

ACAL	rinse time
H	5 sec.

The autocal procedure is now complete. The assembly returns to the measuring position. Normal operation continues.

Note:



If a problem is detected during the sequence, then a changed sequence will be performed, which you can easily follow on the operating panel. The corresponding error number (Err) appears on the display. See chapter 7.1 for error explanations and troubleshooting instructions.

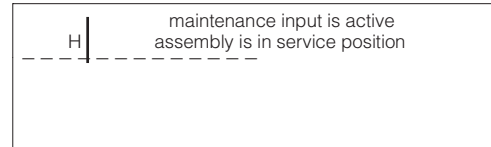
Step 13: **Air valve is open**

ACAL2	air valve is open for
H	5 sec.

6.6 External start inputs

If all relays are closed (no fault present), then a pulse with a duration of min. 500 ms is required at the external start input to start cleaning, HQSS or autocal.
 If the start input remains closed, then cleaning, HQSS or autocal is performed completely.
 After water rinse, the function is interrupted until the start input is opened again.

In the meantime, the electrode is stored in the water under safe and optimum conditions.
 The following message is displayed:



Caution:

For maintenance work at the assembly, the compressed-air supply must additionally be interrupted.

6.7 Relay status

The relay outputs 7K1, 7K2 and 7K3 (terminals -X1) are status outputs.

The relay 7K4 is used for triggering an external cleaning pump.

The relay 7K5 is used for triggering sterilization.

The following table shows the possible status outputs of relays 7K1, 7K2 and 7K3.



Note:

All relays are closed during trouble-free operation.
 If all relays are open, then this indicates a power failure.

Designation		7K1	7K2	7K3
Measuring mode (no fault present)		1	1	1
Power failure		0	0	0
Rinsing / calibration / maintenance – Manual operation – Cleaning cycle (incl. stand by time) – HQSS cycle – Autocal cycle		0	X	X
Maintenance request – Refill cleaner – Refill buffer solution 1 – Refill buffer solution 2	Error no. 05 07 06	X	0	X
Fault – Air pressure failure – Water pressure failure – Service limit position not reached – Measuring limit position not reached – HQSS: Measured value outside window – Autocal: Measured value unstable – Autocal: Zero out of range – Autocal: Slope out of range – pH-measuring unit error – Limit or setpoint exceeded – SCS error (software version 2.02 or later) – Interface error PLC <—> Mycom	Error no. 01 02 03 04 08 35 34 33 12 13 16 32	X	X	0

Legend:

X = independent of relay status
 1 = relay closed, contact closed
 0 = relay open, contact open



Note:


- In case of several error messages, combinations of the relay statuses are possible.
- Mycom-specific error messages are indicated via the alarm relay of the Mycom.

7. Error diagnosis


When the system detects an error, a plain-text error message appears on the operating panel display. For example:

```
-----
Err. 01: Air pressure too low
-----
```

Error messages are indicated by a blinking display.

An error message can be reset by pressing the  key.

Before entering the main menu, all blinking error messages have to be reset.

If the error is removed, then the error message can be deleted from the display by pressing the  key.

The message, however, remains active in the error or operation message list.

If the error is not yet removed, then the display changes from “blinking” to “continuous”.

If several errors have been detected, then they will be displayed in turn after acknowledgement of the preceding error.

In case several errors occur at the same time,

the  and  keys allow you to scroll to

the beginning or to the end of the error list.

The errors that have occurred can be called up in the service menu (see chapter 6.4) at a later point in time as described above.

All possible errors that may occur are listed in the error list in chapter 7.1 in ascending order by error number.

Internal system messages are indicated with the “\$” sign, e. g.:

```
$ 339: End of booting
```

Please observe additionally the notes in the handbook for system control.

Should it prove impossible to clear an error by following the instructions in chapter 7.1, please contact your supplier or authorised Endress+Hauser representative (see back cover of these operating instructions for addresses).










Note:


Please also note the supplied operating instructions for:

- pH measuring transmitter Mycom CPM 151-P
- Retractable pH assembly Probit CPA.

7.1 Error list

Err	Meaning	Elimination
01	Air pressure too low	<ul style="list-style-type: none"> – Check whether medium is supplied to control cabinet. – Listen for whistling or hissing (indication of a leak). – Check whether the pressure drops during the Airtrol system function sequence (air volume too low).
02	Water pressure too low	<ul style="list-style-type: none"> – Check whether medium is supplied to control cabinet. – Look for water puddles in surrounding area (indication of a leak).
03	Service position not reached	<ul style="list-style-type: none"> – Return to the measuring mode via the “auto(matic)” mode. Restart the cleaning process manually. – Check the connections on the retractable pH assembly Probit. – Are the media available (failure of compressed air supply)? – Is the tap cock stuck (CPA 463)? – Try to move the assembly manually.
04	Measurement position not reached	<ul style="list-style-type: none"> – Return to the “man(ual)” mode. Restart the measuring operation by changing over to the “auto(matic)” mode. – Check the connections on the retractable pH assembly Probit. – Are the media available (failure of compressed air supply)? – Try to move the assembly manually.
05	Maintenance request: Refill buffer solution 1	<ul style="list-style-type: none"> – Replace or refill the bottle with buffer solution 1. – Reset the ml counter on the operating panel to the initial value by pressing the  key.
06	Maintenance request: Refill cleaner	<ul style="list-style-type: none"> – Replace or refill the bottle with the cleaner solution. – Reset the ml counter on the operating panel to the initial value by pressing the  key.
07	Maintenance request: Refill buffer solution 2	<ul style="list-style-type: none"> – Replace or refill the bottle with buffer solution 2. – Reset the ml counter on the operating panel to the initial value by pressing the  key.
08	HQSS, measured value outside window	<ul style="list-style-type: none"> – Initiate cleaning process – Renew buffer solution – Are limits in window too narrow? <ul style="list-style-type: none"> – Check pH measuring line – Replace electrode if necessary – Initiate calibration
09	Parameter error Mycom	<ul style="list-style-type: none"> – Check connection of pH measuring line – Initiate cleaning process – Replace electrode if necessary
12	pH-measuring unit error	<p>No entry registered for extended period of time.</p> <ul style="list-style-type: none"> – Press the  key to resume activity. – If appropriate, press the  key to return to the measuring mode.

Err	Meaning	Elimination
13	Limit or setpoint exceeded	Check limit settings on operating unit and alarm settings in pH measuring transmitter Mycom CPM 151-P. – Check actuator, controller function and control parameters on Mycom.
14	Below pH measuring range	– Check pH measurement, pH control and connections – Check pH measuring line
15	pH measuring range exceeded	– Check pH measurement, pH control and connections – Check pH measuring line
16	Sensor, connector or cable defective (SCS error Mycom CPM 151-P)	– Replace pH electrode or dry electrode plug-in head and cable (replace if necessary). Note operating instructions of retractable pH assembly Proprofit CPA.
17	Below temperature measuring range	– Check temperature measurement and connections – Check measuring line and sensor
18	Temperature measuring range exceeded	– Check temperature measurement and connections – Check measuring line and sensor
19	pH output current value below 0 / 4 mA	– Check 0 / 4 mA measuring range assignment on Mycom CPM 151-P and change if necessary – Check measurement and control
20	pH output current value exceeds 20 mA	– Check 20 mA measuring range assignment on Mycom CPM 151-P and change if necessary – Check measurement and control
23	pH measuring range too small (< 2 pH)	pH difference of < 2 pH produces error message – Check measuring range assignment on Mycom CPM 151-P
24	Current output inverted	Parameter limits interchanged. Value V0 / H5 must be smaller than value V0 / H6 (e. g. 2 to 10 pH). See operating instructions of pH measuring transmitter Mycom CPM 151-P.
26	Min. ontime for (Ri or Rd) controller 1 too high	– Decrease value (permissible range: 0.1 to 5.0 seconds)
27	Min. ontime for (Ri or Rd) controller 2 too high	– Decrease value (permissible range: 0.1 to 5.0 seconds)
28	pH buffer solution difference too small	– Choose two buffers with a pH difference > 2 pH – Check buffer solutions and renew if necessary
29	Buffer solution 1 empty	– Replace or refill the bottle with buffer solution 1. – Reset the ml counter on the operating panel to the initial value by pressing the  key.
30	Buffer solution 2 empty	– Replace or refill the bottle with buffer solution 2. – Reset the ml counter on the operating panel to the initial value by pressing the  key.

Err	Meaning	Elimination
31	Cleaner empty	<ul style="list-style-type: none"> – Replace or refill the bottle with the cleaner solution. – Reset the ml counter on the operating panel to the initial value by pressing the  key.
32	Interface error PLC <—> Mycom (CPM 151-P)	<ul style="list-style-type: none"> – Check line connections from Mycom to assembly or PLC – Set main switch to “OFF” – Restart system
33	Outside permissible slope range	<ul style="list-style-type: none"> – Repeat calibration – Renew buffer solutions – Change electrode if necessary – Check instrument and measuring cable with pH simulator – Check set limits
34	Outside permissible zero range	<ul style="list-style-type: none"> – Repeat calibration – Renew buffer solutions – Change electrode if necessary – Check instrument and measuring cable with pH simulator – Check set limits
35	Measured value unstable during calibration (Mycom CPM 151-P)	<ul style="list-style-type: none"> – Check electrical connection (PM?) – Check instrument and measuring cable with pH simulator, if necessary
48	Change PLC battery	Back-up battery of the PLC is dead; <ul style="list-style-type: none"> – Change battery as quickly as possible!*

**Warning:**

* The back-up battery in the PLC must be changed as quickly as possible **when the unit is switched on!** Switching off the unit during battery change will result in the loss of stored data in the memory. The default values will be reactivated.

**Note:**

When the system message “\$ 200: Change battery” is displayed, the back-up battery in the operating unit must be changed. The back-up battery of the operating unit must also be exchanged **before the unit is switched off**. Otherwise the default values are activated.

8. Technical data

pH measurement

pH measuring range	0.00 ... 14.00
Measured value resolution	0.01 pH
Zero shift range	+5.5 ... +9.5 pH
Automatic temperature compensation range	-15 ... +150 °C
Reference temperature	25 °C
Slope adjustment	38 ... 65 mV/pH
pH signal input	optionally symmetrical high-impedance or asymmetrical high-impedance, $2 \times 0.5 \times 10^{12} \Omega$
Temperature sensor	Pt 100, 3-wire arrangement
Signal output	0 / 4 ... 20 mA, galvanically separated
pH signal transmission range	adjustable, $\Delta 2$... $\Delta 14$ pH
Load	max. 600 Ω
Separation voltage	650 Vp-p

Sensor Check System SCS

Limit for error message	
pH measuring chain resistance	$\leq 2 \text{ M}\Omega$
Connection capacitance	$\geq 2 \text{ nF}$

Limits / controllers, alarm, interference

Contact outputs (X1; status contacts Airtrol)	3 × max. 250 V AC / 300 V DC, max. 5 A max. 2000 VA / 35 W
pH error message (X3; Mycom)	1 × max. 250 V AC / 3 A / 500 VA
Limits / controllers (X3; Mycom)	2 contact outputs
Limit contactor function	pulse-length or pulse-frequency controller
Controller response	P / PI / PID
Function type	MIN or MAX (direct / inverted)
Set point adjustment	2 × 0 ... 100% of MR
Hysteresis for limit contacts	1 ... 10% of MR
Contact delay	pickup / dropout 0 ... 6000 s
Contact load	max. 250 V AC, max. 3 A, max. 500 VA

General technical data

Display	LCD, 4-line text display
Ambient temperature – nominal operating range	0 ... 40 °C
Relative humidity	10 ... 90%
Ingress protection	IP 54
Dimensions (H × W × D)	530 × 430 × 200 mm
Total weight	
CPC 200	19.5 kg
CPC 210	17.5 kg

Electrical data

AC voltage for CPC 200	24, 115, 230 V AC, 50 ... 60 Hz (+6 / -10%)
DC voltage for CPC 200	max. 20 ... 30 V
DC voltage for CPC 210	24 V DC (internal)
Power consumption	max. 60 VA
Terminal cross section	max. 2.5 mm ²
Connecting cable between CPC 200 and CPC 210	14 × 0.5 mm ² , 5 m (included in scope of delivery)

Medium connections

Water connection	bulkhead gland, ID 4 / OD 6
Water quality	city water, free of solids
Water pressure	4 ... 6 bar
Compressed air connection	bulkhead gland, ID 4 / OD 6
Air quality	oil and water-free (instrument-quality air); filtered to 5 μm
Air pressure	4 ... 6 bar
Air flow requirement	max. 20 l/min
Multiple pneumatics/assembly hose connection	standard 5 m (incl. in scope of delivery)
Line material	1 × PTFE, 8 × polyurethane
Protective hose	PVC
Control air / media outputs	10-tube plug-in connection

9. Appendix

9.1 Cleaning agents for cleaner reservoir

Soiling / coating	Cleaning agents
Grease and oil	– (Alkaline) agents containing surfactants or – water-soluble, organic solvents, e. g. alcohols
Limestone deposits	Hydrochloric acid, approx. 3%
Metal hydroxide deposits	Hydrochloric acid, approx. 3%
Cyanide deposits	Hydrochloric acid, approx. 3%
Sulphide deposits	Mixture of 3% hydrochloric acid and saturated thiourea (sodium thiosulphate)
Protein coatings	Mixture of 3% hydrochloric acid and saturated pepsin
Fibres, suspended solids	Pressure water, possibly containing wetting agents
Heavy biological coatings	Hydrochloric acid, approx. 3%
Light biological coatings	Pressure water

9.2 Cleaning

For cleaning of keys and housing we recommend commercial, non-abrasive cleaning agents.



Warning:

We do not guarantee resistance to concentrated mineral acids or lyes, benzyl alcohol, methylene chloride and high-pressure steam.

9.3 Maintenance

Note:









- Check hoses and cables for leakage and damage at regular intervals.
- Check to see that the electrical terminal connections are firmly seated.



Warning to system control:

Exchange the back-up battery of the PLC in due time, please. Otherwise, the system data get lost in case of a power failure.

Step	Remark
Acknowledgement following replacement or refilling of buffer or cleaner solution	<p>The system is equipped with a ml counter that registers buffer and cleaner solution consumption. An alarm condition is signalled when approx. 90% of the buffer or cleaner is used up.</p> <p>If the buffer solution 1 bottle has been refilled, this must be acknowledged and signalled to the Airtrol as follows:</p> <p>Press the  +  keys.</p> <p>Proceed analogously for the other two bottles, however, by pressing the following keys:</p> <ul style="list-style-type: none"> – for buffer solution 2:  +  – for cleaner solution:  + 

9.4 Bus cable properties

Features	Values
Type of cable	2-core, twisted and screened
Surge impedance	approx. 135 ... 160 Ω (f = 3 ... 20 MHz)
Loop impedance	≥ 115 Ω/km
Effective capacitance	30 nF/km
Attenuation	0.9 dB/100 (f = 200 kHz)
Permissible wire cross section	0.3 mm ² ... 0.5 mm ²
Permissible cable diameter	8 mm ± 0.5 mm
Maximum cable length	400 m (at 500 kbaud)

9.5 System control S5-95U – Display and operating elements

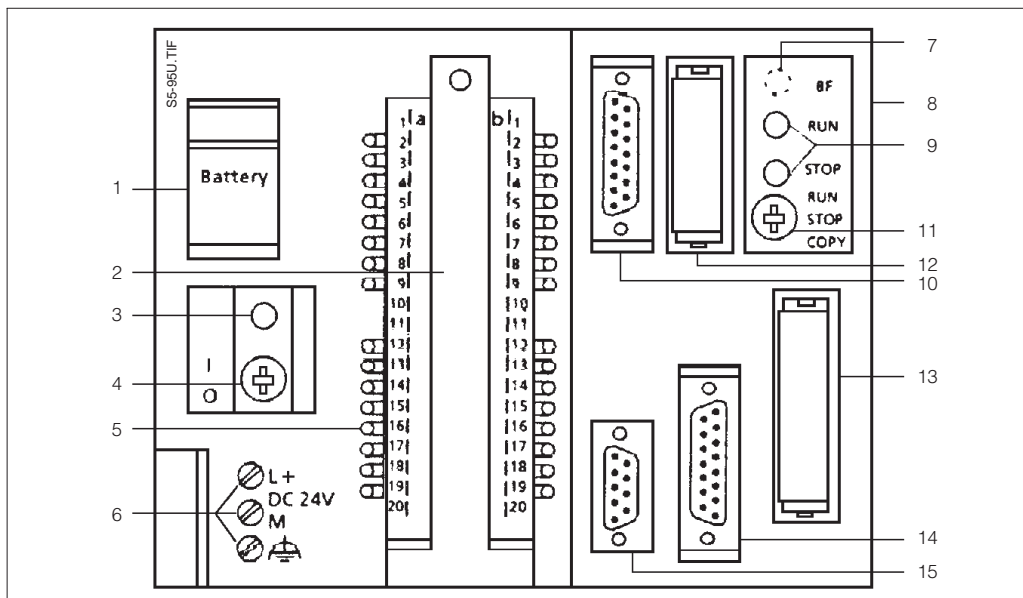


Fig. 9.1: System control S5-95U Display and operating elements and interfaces

Legend:

- 1 Battery box
 - 2 Front plug for digital inputs and digital outputs
 - 3 Display for low battery
 - 4 On / Off switch
 - 5 LED for digital inputs and digital outputs
 - 6 Terminals for power supply
 - 7 – on S5-95U, order no. 6ES5 095-8MB... SINEC L2 bus error LED
– on S5-95U, order no. 6ES5 095-8MD... SINEC L2-DP bus error LED
 - 8 Connector for S5-100U components
 - 9 Display for operating modes
– green LED = RUN
– red LED = STOP
 - 10 Interface for analogue inputs and analogue output
 - 11 Switch for operating mode
 - 12 L2 bus connector
- Note:**
- Do not remove L2 bus connector!
 - Switch position must be set to "ON" on single system.
- 13 Controller memory seat: E(E)PROM
 - 14 Interface for programming device, PC, operator panel or SINEC L1 bus
 - 15 Interface for alarm inputs and counter inputs

9.6 Accessories

The following accessories can be ordered separately:

- Retractable pH assembly Probit CPA 463 for Airtrol CPC 200 / 210
Order no. CPA 463-A
- Retractable pH assembly Probit CPA 463S for Airtrol CPC 200 / 210
Order no. CPA 463S-A
- Special pH cable CPK 7 for electrodes with an integrated Pt 100 temperature sensor, with dual screen and PVC jacket
Temperature range: -25 ... +85 °C
Cable length: min. 5 m
Cable diameter: 7 mm
Order no. CPK 7-05
- Buffer solution pH 7.0
Order no. CPY 2-3
- Buffer solution pH 4.01
Order no. CPY 2-1
- pH electrode Orbisint CPS 11-2 AA5 TSA for Probit CPA 463-A and CPA 463S-A
Order no. CPS 11-2 AA5 TSA
- pH electrode Orbisint CPS 11-2 BA5 TSA for Probit CPA 463-A and CPA 463S-A
Order no. CPS 11-2 BA5 TSA
- pH electrode Ceraliquid CPS 41-2 BB5 TSS for Probit CPA 463-A0, -A2, -A4 and CPA 463S-A0xxx
Order no. CPS 41-2 BB5 TSS

9.7 Index

- A**
- Access code 26, 33
 - Access level 27
 - Accessories 50
 - Acknowledge replacement / refilling
 - of buffer solution 17, 48
 - Acknowledge replacement / refilling
 - of cleaner solution 17, 48
 - Air valve 39, 41
 - Airtrol menu structure 24-25
 - Appendix 48-52
 - Areas of application 2
 - Auto(matic) mode of operation 23, 35-41
 - Autocal 30
 - Autocal function 40-41
 - Autocal settings 30
- B**
- Back-pressure water 19, 31
 - Back-up battery of the operating unit 46
 - Back-up battery of the PLC 46, 48
 - Basics for connection 11
 - Basics for installation 5
 - Buffer and cleaner solutions 10
 - Buffer settings 17, 31
 - Bus cable properties 49
- C**
- Calibration limits 28
 - Cleaning 48
 - Cleaning agents for cleaner reservoir 48
 - Cleaning function 36-37
 - Cleaning settings 19, 29, 31
 - Clock settings 19, 32
 - Code: see Access code
 - Code "1111":
 - see Password access level 3
 - Code "2222":
 - see Password access level 9
 - Compressed air connection 10
 - Connection diagram 11
 - Connection diagram, overall 12
 - Connection of CPC 200 to CPC 210 13
 - Connection to retractable pH assembly 10
 - Connection type for pH transmitter 13
 - Connective networking
 - of several systems via Profibus 13-14, 49
 - Control diagram "autocal" 40
 - Control diagram "cleaning" 36
 - Control diagram "HQSS" 38
- D**
- Display 21
 - Display, enlarged indication 21
 - Display, normal indication 21
- E**
- Electrical connection 11-14
 - Enlarged display indication 21
 - Error diagnosis 43-46
 - Error list 44-46
 - Error messages 34, 43
 - Example of an error message 34
 - Example of an operation message 34
 - External cleaning 36
 - External start inputs 42
- F**
- Flow diagram 9
- G**
- General 2-3
 - General start-up notes 15
 - General times 30
- H**
- HQSS 29
 - HQSS function 38-39
 - HQSS settings 29
- I**
- Installation 5-10
 - Installation overview 6-7
 - Interval mode 30, 35
- K**
- Key functions 22
 - Keypad 22
- L**
- Limit settings 19, 28
- M**
- Maintenance 48
 - Manual mode of operation 23
 - Measuring mode (Auto(matic)) 35
 - Measuring system 4
 - Menu function keys 22
 - Menu structure 24-25
 - Modes of operation 23
- N**
- Normal display indication 21
- O**
- Operating modes: see Modes of operation
 - Operating panel 21
 - Operation 21-42
 - Operation messages 34
 - Ordering system 3

P		T	
Password	17, 26-27, 33	Table of contents	1
Password access level 1	17, 26, 33	Technical data	47
Password access level 3	17, 26, 33	Temperature configuration	28
Password access level 3:		Temperature limits	28
Code "1111"	17, 26, 33	Time settings	18, 29-30
Password access level 9	17, 26, 33	Times for interval mode	30
Password access level 9:			
Code "2222"	17, 26, 33	U	
Password entry	26-27, 33	Unpacking	2
Password factory setting	26		
Password menu	17, 33	V	
Password settings	33	Volume settings	17, 32
pH configuration	28		
pH limits	28	W	
Pneumatic connection	8-9	Water connection	10
		Water valve	37-41
R			
Real time mode	35		
Relay status	42		
S			
Service	34		
Signal output	16		
Single menus	26-33		
Start times	29		
Start-up	15-20		
Start-up sequence	16-20		
Start-up: Functional test	20		
Start-up: Settings			
on Airtrol system	16		
on measuring transmitter	16		
via operating panel	17-19		
Sterilization	30		
Sterilization time	30		
System control S5-95U	49		
System keypad	22		
System messages	34, 43, 46		

Europe

Austria

□ Endress+Hauser Ges.m.b.H.
Wien
Tel. (02 22) 8 80 56-0, Fax (02 22) 8 80 56-35

Belarus

Belorgsintez
Minsk
Tel. (01 72) 26 31 66, Fax (01 72) 26 31 11

Belgium / Luxembourg

□ Endress+Hauser S.A./N.V.
Brussels
Tel. (02) 2 48 06 00, Fax (02) 2 48 05 53

Bulgaria

INTERTECH-AUTOMATION
Sofia
Tel. (02) 65 28 09, Fax (02) 65 28 09

Croatia

□ Endress+Hauser GmbH+Co.
Zagreb
Tel. (01) 660 14 18, Fax (01) 660 14 18

Cyprus

I+G Electrical Services Co. Ltd.
Nicosia
Tel. (02) 48 47 88, Fax (02) 48 46 90

Czech Republic

□ Endress+Hauser GmbH+Co.
Ostrava
Tel. (069) 6 61 19 48, Fax (069) 6 61 28 69

Denmark

□ Endress+Hauser A/S
Søborg
Tel. (31) 67 31 22, Fax (31) 67 30 45

Estonia

Elvi-Aqua-Teh
Tartu
Tel. (07) 42 27 26, Fax (07) 42 27 27

Finland

□ Endress+Hauser Oy
Espoo
Tel. (90) 8 59 61 55, Fax (90) 8 59 60 55

France

□ Endress+Hauser
Huningue
Tel. (03) 89 69 67 68, Fax (03) 89 69 48 02

Germany

□ Endress+Hauser Meßtechnik GmbH+Co.
Weil am Rhein
Tel. (076 21) 975-01, Fax (076 21) 975-555

Great Britain

□ Endress+Hauser Ltd.
Manchester
Tel. (01 61) 2 86 50 00, Fax (01 61) 9 98 18 41

Greece

I & G Building Services Automation S.A.
Athens
Tel. (01) 9 24 15 00, Fax (01) 9 22 17 14

Hungary

Mile Ipari-Elektro
Budapest
Tel. (01) 2 61 55 35, Fax (01) 2 61 55 35

Iceland

Vatnshreinsun HF
Reykjavik
Tel. (00354) 88 96 16, Fax (00354) 88 96 13

Ireland

Flomeaco Company Ltd.
Kildare
Tel. (045) 86 86 15, Fax (045) 86 81 82

Italy

□ Endress+Hauser Italia S.p.A.
Cernusco s/N Milano
Tel. (02) 92 10 64 21, Fax (02) 92 10 71 53

Latvia

Raita Ltd.
Riga
Tel. (02) 26 40 23, Fax (02) 26 41 93

Lithuania

Agava Ltd.
Kaunas
Tel. (07) 20 24 10, Fax (07) 20 74 14

Netherlands

□ Endress+Hauser B.V.
Naarden
Tel. (035) 6 95 86 11, Fax (035) 6 95 88 25

Norway

□ Endress+Hauser A/S
Tranby
Tel. (032) 85 10 85, Fax (032) 85 11 12

Poland

□ Endress+Hauser Polska Sp. z o.o.
Warsaw
Tel. (022) 6 51 01 74, Fax (022) 6 51 01 78

Portugal

Tecnisis - Tecnica de Sistemas Industriais
Linda-a-Velha
Tel. (01) 4 17 26 37, Fax (01) 4 18 52 78

Romania

Romconseng SRL
Bucharest
Tel. (01) 4 10 16 34, Fax (01) 4 10 16 34

Russia

Avtomatika-Sever Ltd.
St. Petersburg
Tel. (08 12) 5 56 13 21, Fax (08 12) 5 56 13 21

Slovak Republic

Transcom Technik s.r.o.
Bratislava
Tel. (07) 5 21 31 61, Fax (07) 5 21 31 81

Slovenia

□ Endress+Hauser D.O.O.
Ljubljana
Tel. (061) 1 59 22 17, Fax (061) 1 59 22 98

Spain

□ Endress+Hauser S.A.
Barcelona
Tel. (93) 4 73 46 44, Fax (93) 4 73 38 39

Sweden

□ Endress+Hauser AB
Sollentuna
Tel. (08) 6 26 16 00, Fax (08) 6 26 94 77

Switzerland

□ Endress+Hauser AG
Reinach/BL 1
Tel. (061) 7 15 62 22, Fax (061) 7 11 16 50

Turkey

Intek Endüstriyel Ölçü ve Kontrol Sistemleri
Istanbul
Tel. (02 12) 2 75 13 55, Fax (02 12) 2 66 27 75

Ukraine

Industria Ukraina
Kiev
Tel. (044) 2 68 52 13, Fax (044) 2 68 52 13

Africa

Morocco

Oussama S.A.
Casablanca
Tel. (02) 24 13 38, Fax (02) 40 26 57

South Africa

□ Endress+Hauser Pty. Ltd.
Sandton
Tel. (11) 4 44 13 86, Fax (11) 4 44 19 77

Tunisia

Controle, Maintenance et Regulation
Tunis
Tel. (01) 79 30 77, Fax (01) 78 85 95

America

Argentina

Servotron SACIFI
Buenos Aires
Tel. (01) 7 02 11 22, Fax (01) 3 34 01 04

Bolivia

Tritec S.R.L.
Cochabamba
Tel. (042) 5 69 93, Fax (042) 5 09 81

Brazil

Servotek
Sao Paulo
Tel. (011) 5 36 34 55, Fax (011) 5 36 30 67

Canada

□ Endress+Hauser Ltd.
Burlington, Ontario
Tel. (905) 6 81 92 92, Fax (905) 6 81 94 44

Chile

DIN Instrumentos Ltda.
Santiago
Tel. (02) 2 05 01 00, Fax (02) 2 25 81 39

Colombia

Colsein Ltd.
Santafe de Bogota D.C.
Tel. (01) 2 36 76 59, Fax (01) 6 10 78 68

Costa Rica

EURO-TEC S.A.
San Jose
Tel. (0506) 2 96 15 42, Fax (0506) 2 96 15 42

Ecuador

Insetec Cia. Ltda.
Quito
Tel. (02) 46 18 33, Fax (02) 46 18 33

Guatemala

ACISA Automatizaci3n Y Control
Ciudad de Guatemala, C.A.
Tel. (02) 334 59 85, Fax (02) 332 74 31

Mexico

Endress+Hauser Instruments International
Mexico City Office, Mexico D.F.
Tel. (05) 5 68 96 58, Fax (05) 5 68 41 83

Paraguay

INCOEL S.R.L.
Asuncion
Tel. (021) 20 34 65, Fax (021) 2 65 83

Peru

Esim S.A.
Lima
Tel. (01) 4 71 46 61, Fax (01) 4 71 09 93

Uruguay

Circular S.A.
Montevideo
Tel. (02) 92 57 85, Fax (02) 92 91 51

USA

□ Endress+Hauser Inc.
Greenwood, Indiana
Tel. (317) 5 35-71 38, Fax (317) 5 35-14 89

Venezuela

H. Z. Instrumentos C.A.
Caracas
Tel. (02) 9 79 88 13, Fax (02) 9 79 96 08

Asia

China

□ Endress+Hauser Shanghai
Shanghai
Tel. (021) 6 46 46 70 00, Fax (021) 6 47 4 78 60

Hong Kong

□ Endress+Hauser (H.K.) Ltd.
Hong Kong
Tel. (0852) 25 28 31 20, Fax (0852) 28 65 41 71

India

□ Endress+Hauser India Branch Office
Mumbai
Tel. (022) 6 04 55 78, Fax (022) 6 04 02 11

Indonesia

PT Grama Bazita
Jakarta
Tel. (021) 7 97 50 83, Fax (021) 7 97 50 89

Japan

□ Sakura Endress Co., Ltd.
Tokyo
Tel. (422) 54 06 11, Fax (422) 55 02 75

Malaysia

□ Endress+Hauser (M) Sdn. Bhd.
Petaling Jaya, Selangor Darul Ehsan
Tel. (03) 7 33 48 48, Fax (03) 7 33 88 00

Pakistan

Speedy Automation
Karachi
Tel. (021) 772 29 53, Fax (021) 773 68 84

Philippines

Brenton Industries Inc.
Makati Metro Manila
Tel. (2) 8 43 06 61, Fax (2) 8 17 57 39

Singapore

□ Endress+Hauser (S.E.A.) Pte., Ltd.
Singapore
Tel. 4 68 82 22, Fax 4 66 68 48

South Korea

Hitrol Co. Ltd.
Bucheon City
Tel. (032) 6 72 31 31, Fax (032) 6 72 00 90

Taiwan

Kingjarl Corporation
Taipei R.O.C.
Tel. (02) 7 18 39 38, Fax (02) 7 13 41 90

Thailand

□ Endress+Hauser Ltd.
Bangkok
Tel. (02) 9 96 78 11-20, Fax (02) 9 96 78 10

Vietnam

Tan Viet Bao Co. Ltd.
Ho Chi Minh City
Tel. (8) 8 33 52 25, Fax (8) 8 33 52 27

Iran

Telephone Technical Services Co. Ltd.
Tehran
Tel. (021) 87 46 75 54, Fax (021) 8 73 72 95

Israel

Instrumetrics Industrial Control Ltd.
Tel-Aviv
Tel. (03) 6 48 02 05, Fax (03) 6 47 19 92

Jordan

A.P. Parpas Engineering S.A.
Amman
Tel. (06) 55 92 83, Fax (06) 55 92 05

Kingdom of Saudi Arabia

Anasia
Jeddah
Tel. (03) 6 71 00 14, Fax (03) 6 72 59 29

Kuwait

Kuwait Maritime & Mercantile Co. K.S.C.
Safat
Tel. (05) 2 43 47 52, Fax (05) 2 44 14 86

Lebanon

Network Engineering Co.
Jbeil
Tel. (01) 325 40 52, Fax (01) 994 40 80
Mustafa & Jawad Science & Industry Co. L.L.C.
Ruwi
Tel. (08) 60 20 09, Fax (08) 60 70 66

United Arab Emirates

Descon Trading EST.
Dubai
Tel. (04) 35 95 22, Fax (04) 35 96 17

Yemen

Yemen Company for Ghee and Soap Industry
Taiz
Tel. (04) 23 06 65, Fax (04) 21 23 38

Australia + New Zealand

Australia

GEC Alsthom LTD.
Sydney
Tel. (02) 6 45 07 77, Fax (02) 96 45 08 18

New Zealand

EMC Industrial Instrumentation
Auckland
Tel. (09) 4 44 92 29, Fax (09) 4 44 11 45

All other countries

□ Endress+Hauser GmbH+Co.
Instruments International
Weil am Rhein, Germany
Tel. (076 21) 9 75-02, Fax (076 21) 9 75 34 5

□ Members of the Endress+Hauser group



50061226

Endress + Hauser

Nothing beats know-how

