



S-PM GEARED MOTOR DRIVE UNIT FR-D700-G INSTRUCTION MANUAL (BASIC) FR-D720-0.2K to 3.7K-G

1

2

3

4

5

6

7

8

9

Thank you for choosing this Mitsubishi Electric S-PM geared motor drive unit.
This Instruction Manual (Basic) provides handling information and precautions for use of the equipment.
Please forward this Instruction Manual (Basic) to the end user.

CONTENTS

[1] OUTLINE	1
[2] INSTALLATION AND WIRING	5
[3] PRECAUTIONS FOR USE OF THE DRIVE UNIT	16
[4] FAILSAFE OF THE SYSTEM WHICH USES THE DRIVE UNIT	18
[5] DRIVE THE MOTOR	19
[6] PARAMETERS	27
[7] TROUBLESHOOTING	31
[8] PRECAUTIONS FOR MAINTENANCE AND INSPECTION	36
[9] SPECIFICATIONS	38



To obtain the Instruction Manual (Applied)

Contact where you purchased the drive unit, your Mitsubishi Electric sales representative, or the nearest Mitsubishi Electric FA Center for the following manuals:

- *Instruction Manual (Applied) [IB(NA)-0600478ENG]*

These manuals are required if you are going to utilize functions and performance.

The PDF version of this manual is also available for download at the "Mitsubishi Electric Factory Automation Website", which is an information service offered on the Internet.

(URL: www.MitsubishiElectric.co.jp/fa/)

This Instruction Manual (Basic) provides handling information and precautions for use of the equipment. Please forward this Instruction Manual (Basic) to the end user.

This section is specifically about safety matters

Do not attempt to install, operate, maintain or inspect the drive unit until you have read through the Instruction Manual (Basic) and appended documents carefully and can use the equipment correctly. Do not use this product until you have a full knowledge of the equipment, safety information and instructions.

In this Instruction Manual (Basic), the safety instruction levels are classified into "WARNING" and "CAUTION".

⚠ WARNING Incorrect handling may cause hazardous conditions, resulting in death or severe injury.

⚠ CAUTION Incorrect handling may cause hazardous conditions, resulting in medium or slight injury, or may cause only material damage.

The **⚠ CAUTION** level may even lead to a serious consequence according to conditions. Both instruction levels must be followed because these are important to personal safety.

1. Electric Shock Prevention

⚠ WARNING

- While power is ON or when the drive unit is running, do not open the front cover. Otherwise you may get an electric shock.
- Do not run the drive unit with the front cover or wiring cover removed. Otherwise you may access the exposed high-voltage terminals or the charging part of the circuitry and get an electric shock.
- Even if power is OFF, do not remove the front cover except for wiring or periodic inspection. You may accidentally touch the charged drive unit circuits and get an electric shock.
- Before wiring or inspection, power must be switched OFF. To confirm that, LED indication of the operation panel must be checked. (It must be OFF.) Any person who is involved in wiring or inspection shall wait for at least 10 minutes after the power supply has been switched OFF and check that there are no residual voltage using a tester or the like. The capacitor is charged with high voltage for some time after power OFF, and it is dangerous.
- This drive unit must be earthed (grounded). Earthing (grounding) must conform to the requirements of national and local safety regulations and electrical code (NEC section 250, IEC 536 class 1 and other applicable standards).
- Any person who is involved in wiring or inspection of this equipment shall be fully competent to do the work.
- The drive unit must be installed before wiring. Otherwise you may get an electric shock or be injured.
- Setting dial and key operations must be performed with dry hands to prevent an electric shock. Otherwise you may get an electric shock.
- Do not subject the cables to scratches, excessive stress, heavy loads or pinching. Otherwise you may get an electric shock.
- Do not change the cooling fan while power is ON. It is dangerous to change the cooling fan while power is ON.
- Do not touch the printed circuit board or handle the cables with wet hands. Otherwise you may get an electric shock.
- When measuring the main circuit capacitor capacity, the DC voltage is applied to the motor for 1s at powering OFF. Never touch the motor terminal, etc. right after powering OFF to prevent an electric shock.
- A PM motor is a synchronous motor with embedded magnets. High-voltage is generated at motor terminals while the motor is running even after the drive unit power is turned OFF. Before wiring or inspection, the motor must be confirmed to be stopped. For applications where the motor is driven by the load, the low-voltage manual contactor, which is installed at the drive unit's output side, must be opened before wiring or inspection. Otherwise you may get an electric shock.

2. Fire Prevention

⚠ CAUTION

- Drive unit must be installed on a nonflammable wall without holes (so that nobody touches the drive unit heatsink on the rear side, etc.). Mounting it to or near flammable material can cause a fire.
- If the drive unit has become faulty, the drive unit power must be switched OFF. A continuous flow of large current could cause a fire.
- When using a brake resistor, a sequence that will turn OFF power when a fault signal is output must be configured. Otherwise the brake resistor may overheat due to damage of the brake transistor and possibly cause a fire.
- Do not connect a resistor directly to the DC terminals P/+ and N/-. Doing so could cause a fire.

3. Injury Prevention

⚠ CAUTION

- The voltage applied to each terminal must be the ones specified in the Instruction Manual. Otherwise burst, damage, etc. may occur.
- The cables must be connected to the correct terminals. Otherwise burst, damage, etc. may occur.
- Polarity must be correct. Otherwise burst, damage, etc. may occur.
- While power is ON or for some time after power-OFF, do not touch the drive unit since the drive unit will be extremely hot. Doing so can cause burns.

4. Additional Instructions

Also the following points must be noted to prevent an accidental failure, injury, electric shock, etc.

(1) Transportation and Mounting

⚠ CAUTION

- The product must be transported in correct method that corresponds to the weight. Failure to do so may lead to injuries.
- Do not stack the boxes containing drive units higher than the number recommended.
- The product must be installed to the position where withstands the weight of the product according to the information in the Instruction Manual.
- Do not install or operate the drive unit if it is damaged or has parts missing.
- When carrying the drive unit, do not hold it by the front cover or setting dial; it may fall off or fail.
- Do not stand or rest heavy objects on the product.
- The drive unit mounting orientation must be correct.
- Foreign conductive objects must be prevented from entering the drive unit. That includes screws and metal fragments or other flammable substance such as oil.
- As the drive unit is a precision instrument, do not drop or subject it to impact.
- The drive unit must be used under the following environment: Otherwise the drive unit may be damaged.

Environment	Surrounding air temperature	-10°C to +50°C (non-freezing)
	Ambient humidity	90%RH or less (non-condensing)
	Storage temperature	-20°C to +65°C *
	Atmosphere	Indoors (free from corrosive gas, flammable gas, oil mist, dust and dirt)
	Altitude/ vibration	Maximum 1,000m above sea level. 5.9m/s ² or less at 10 to 55Hz (directions of X, Y, Z axes)

* Temperature applicable for a short time, e.g. in transit.

(2) Wiring

CAUTION

- Do not install a power factor correction capacitor or surge suppressor/capacitor type filter on the drive unit output side. These devices on the drive unit output side may be overheated or burn out.
- The connection orientation of the output cables U, V, W to the motor affects the rotation direction of the motor.
- PM motor terminals (U, V, W) hold high-voltage while the PM motor is running even after the power is turned OFF. Before wiring, the PM motor must be confirmed to be stopped. Otherwise you may get an electric shock.
- Never connect a PM motor to the commercial power supply. Applying the commercial power supply to input terminals (U, V, W) of a PM motor will burn the PM motor. The PM motor must be connected with the output terminals (U, V, W) of the drive unit.

(3) Trial run

CAUTION

- Before starting operation, each parameter must be confirmed and adjusted. A failure to do so may cause some machines to make unexpected motions.

(4) Usage

WARNING

- A PM motor and the drive unit must be used in the specified capacity combination.
- Do not use multiple PM motors with one drive unit.
- Any person must stay away from the equipment when the retry function is set as it will restart suddenly after trip.
- Since pressing  key may not stop output depending on the function setting status, separate circuit and switch that make an emergency stop (power OFF, mechanical brake operation for emergency stop, etc.) must be provided.
- OFF status of the start signal must be confirmed before resetting the drive unit fault. Resetting drive unit alarm with the start signal ON restarts the motor suddenly.
- Do not use a PM motor in an application where a motor is driven by its load and runs at a speed higher than the maximum motor speed.
- Do not use a synchronized, induction, or induced-synchronized motor, that is not a dedicated PM motor.
- Do not use the drive unit for a load other than the dedicated PM motor.
Connection of any other electrical equipment to the drive unit output may damage the equipment.
- Do not modify the equipment.
- Do not perform parts removal which is not instructed in this manual. Doing so may lead to fault or damage of the product.

CAUTION

- The electronic thermal relay function does not guarantee protection of the motor from overheating. It is recommended to install an external thermal for overheat protection.
- Do not use a magnetic contactor on the drive unit input for frequent starting/stopping of the drive unit. Otherwise, the life of the drive unit decreases.
- The effect of electromagnetic interference must be reduced by using an EMC filter or by other means. Otherwise nearby electronic equipment may be affected.
- Appropriate measures must be taken to suppress harmonics. Otherwise power supply harmonics from the drive unit may heat/damage the power factor correction capacitor and generator.
- When parameter clear or all parameter clear is performed, the required parameters must be set again before starting operations because all parameters return to the initial value.
- The drive unit can be easily set for high-speed operation. Before changing its setting, the performances of the motor and machine must be fully examined.
- Stop status cannot be hold by the drive unit's brake function. In addition to the drive unit's brake function, a holding device must be installed to ensure safety.
- Before running a drive unit which had been stored for a long period, inspection and test operation must be performed.
- Static electricity in your body must be discharged before you touch the product. Otherwise the product may be damaged.
- In the system with a PM motor, the drive unit power must be turned ON before closing the contacts of the contactor at the output side.
- If you are installing the drive unit to drive a three-phase device while you are contracted for lighting and power service, consult your electric power supplier.

(5) Emergency stop

CAUTION

- A safety backup such as an emergency brake must be provided to prevent hazardous condition to the machine and equipment in case of drive unit failure.
- When the breaker on the drive unit input side trips, the wiring must be checked for fault (short circuit), and internal parts of the drive unit for a damage, etc. The cause of the trip must be identified and removed before turning ON the power of the breaker.
- When any protective function is activated, appropriate corrective action must be taken, and the drive unit must be reset before resuming operation.

(6) Maintenance, inspection and parts replacement

CAUTION

- Do not carry out a megger (insulation resistance) test on the control circuit of the drive unit. It will cause a failure.

(7) Disposal

CAUTION

- The drive unit must be treated as industrial waste.

General instruction

Many of the diagrams and drawings in this Instruction Manual (Basic) show the drive unit without a cover or partially open for explanation. Never operate the drive unit in this manner. The cover must be always reinstalled and the instruction in this Instruction Manual (Basic) must be followed when operating the drive unit. For more details on a dedicated PM motor, refer to the Instruction Manual of the dedicated PM motor.

<Abbreviation>

PU	Operation panel and parameter unit (FR-PU07)
Drive unit.....	The FR-D700-G series drive unit for Mitsubishi S-PM geared motor
FR-D700-G.....	The FR-D700-G series drive unit for Mitsubishi S-PM geared motor
Pr.	Parameter number (Number assigned to function)
PU operation.....	Operation using the PU (operation panel/FR-PU07)
External operation.....	Operation using the control circuit signals
Combined operation	Operation using both the PU (operation panel/FR-PU07) and External operation
PM motor	The S-PM series dedicated magnet (PM) motor

<Trademark>

• Company and product names herein are the trademarks and registered trademarks of their respective owners.

<Mark>



REMARKS :Additional helpful contents and relations with other functions are stated.



NOTE :Contents requiring caution or cases when set functions are not activated are stated.



POINT :Useful contents and points are stated.

<Related document>

 Refer to the *Instruction Manual (Applied)* for further information on the following points.

- Removal and reinstallation of the cover
- Connection of stand-alone option unit
- EMC and leakage currents
- Detailed explanation on parameters
- Troubleshooting
- Check first when you have a trouble
- Inspection items (life diagnosis, cooling fan replacement)
- Measurement of main circuit voltages, currents and powers

Harmonic suppression guideline (when drive units are used in Japan)

All models of general-purpose inverters used by specific consumers are covered by "The Harmonic Suppression Guideline for Consumers Who Receive High Voltage or Special High Voltage". (For further details,  refer to *Chapter 3 of the Instruction Manual (Applied)*.)

1 OUTLINE

1.1 Product checking and parts identification

Unpack the drive unit and check the capacity plate on the front cover and the rating plate on the drive unit side face to ensure that the product agrees with your order and the drive unit is intact.

● Drive unit model

FR - D720 - 1.5 K - G

Symbol	Voltage class
D720	Three-phase 200V class

Represents the drive unit capacity [kW]

Represents the S-PM geared motor drive

Cooling fan
The cooling fan is removable.
 Refer to the Instruction Manual (Applied)

Operation panel
(Refer to page 2)

Voltage/current input switch
(Refer to page 8)

PU connector
(Refer to page 8)

Front cover
Refer to the Instruction Manual (Applied) for installation/removal.

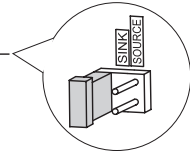

Control logic switchover jumper connector
The jumper connector is in the sink logic (SINK) when shipped from the factory. Move the jumper connector to change to the source logic (SOURCE). Always fit the jumper connector to the either position.
 Refer to the Instruction Manual (Applied)

Control circuit terminal block
(Refer to page 9)

Main circuit terminal block
(Refer to page 9)

Combed shaped wiring cover
 Refer to the Instruction Manual (Applied) for installation/removal.

Capacity plate

FR-D720-1.5K-G SERIAL : XXXXXX

↑ Drive unit model ↑ Serial number

Rating plate Production year and month

	MITSUBISHI	DRIVE UNIT DATE: XXX-XX
Drive unit model	MODEL FR-D720-1.5K-G	
Input rating	INPUT : XXXXX	
Output rating	OUTPUT : XXXXX	
Serial number	SERIAL : _____	
	MITSUBISHI ELECTRIC CORPORATION	PASSED
	MODEL NO. 50001	

● Accessory

- Fan cover fixing screws (M3 × 35mm)

Capacity	Quantity
0.2K to 0.75K	none
1.5K to 3.7K	1

These screws are necessary for compliance with the EU Directive. (Refer to page 41)

REMARKS

- For how to find the SERIAL number, refer to page 44.
- Caution stickers are enclosed with this instruction manual. These caution stickers include stickers that are used for the automatic restart after instantaneous power failure function, which are not required for FR-D700-G.

1.2 Operation panel

1.2.1 Names and functions of the operation panel

The operation panel cannot be removed from the drive unit.

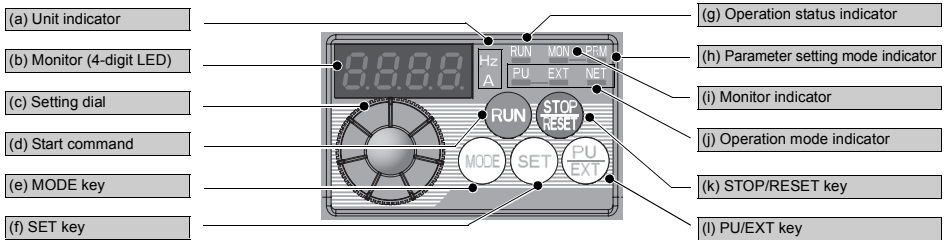

No.	Component	Name	Description
(a)		Unit indicator	Hz: Lit to indicate frequency. (Flickers when the set frequency monitor is displayed.) A: Lit to indicate current. (Both "Hz" and "A" are lit to indicate a value other than frequency or current.)
(b)		Monitor (4-digit LED)	Shows the speed, parameter number, etc. (To monitor the output power, the set speed and other items, set Pr. 52.)
(c)		Setting dial	The dial of the Mitsubishi drive unit. The setting dial is used to change the speed and parameter settings. Press to display the following. <ul style="list-style-type: none"> • Displays the set speed in the monitor mode • Present set value is displayed during calibration • Displays the order in the faults history mode
(d)		Start command	Select the rotation direction in Pr. 40.
(e)		MODE key	Used to switch among different setting modes. Pressing simultaneously changes the operation mode. Holding this key for 2 seconds locks the operation. The key lock is invalid when Pr. 161 = "0 (initial setting)." Refer to the Instruction Manual (Applied)
(f)		SET key	Used to enter a setting. If pressed during the operation, monitored item changes as the following: <div style="border: 1px solid black; padding: 5px; display: inline-block;"> Rotation speed → Output current → Output voltage </div>
(g)		Operation status indicator	Lit or flickers during drive unit operation. * Lit: When the forward rotation operation is being performed. Slow flickering (1.4s cycle): When the reverse rotation operation is being performed. Fast flickering (0.2s cycle): When has been pressed or the start command has been given, but the operation cannot be made. <ul style="list-style-type: none"> • When the speed command is less than the starting speed. • When the MRS signal is being input.
(h)		Parameter setting mode indicator	Lit to indicate the parameter setting mode.
(i)		Monitor indicator	Lit to indicate the monitor mode.
(j)		Operation mode indicator	PU: Lit to indicate the PU operation mode. EXT: Lit to indicate the External operation mode.(EXT is lit at power-ON in the initial setting.) NET: Lit to indicate the Network operation mode. PU and EXT: Lit to indicate EXT/PU combined operation mode 1 and 2 All of these indicators are OFF when the command source is not at the operation panel.
(k)		STOP/RESET key	Used to stop operation commands. Used to reset a fault when the protective function (fault) is activated.
(l)		PU/EXT key	Used to switch between the PU and External operation modes. To use the External operation mode (operation using a separately connected speed setting potentiometer and start signal), press this key to light up the EXT indicator. (Press simultaneously (0.5s), or change the Pr. 79 setting to change to the combined operation mode. Refer to the Instruction Manual (Applied)) PU: PU operation mode EXT: External operation mode Used to cancel the PU stop also.

1.2.2 Basic operation (factory setting)

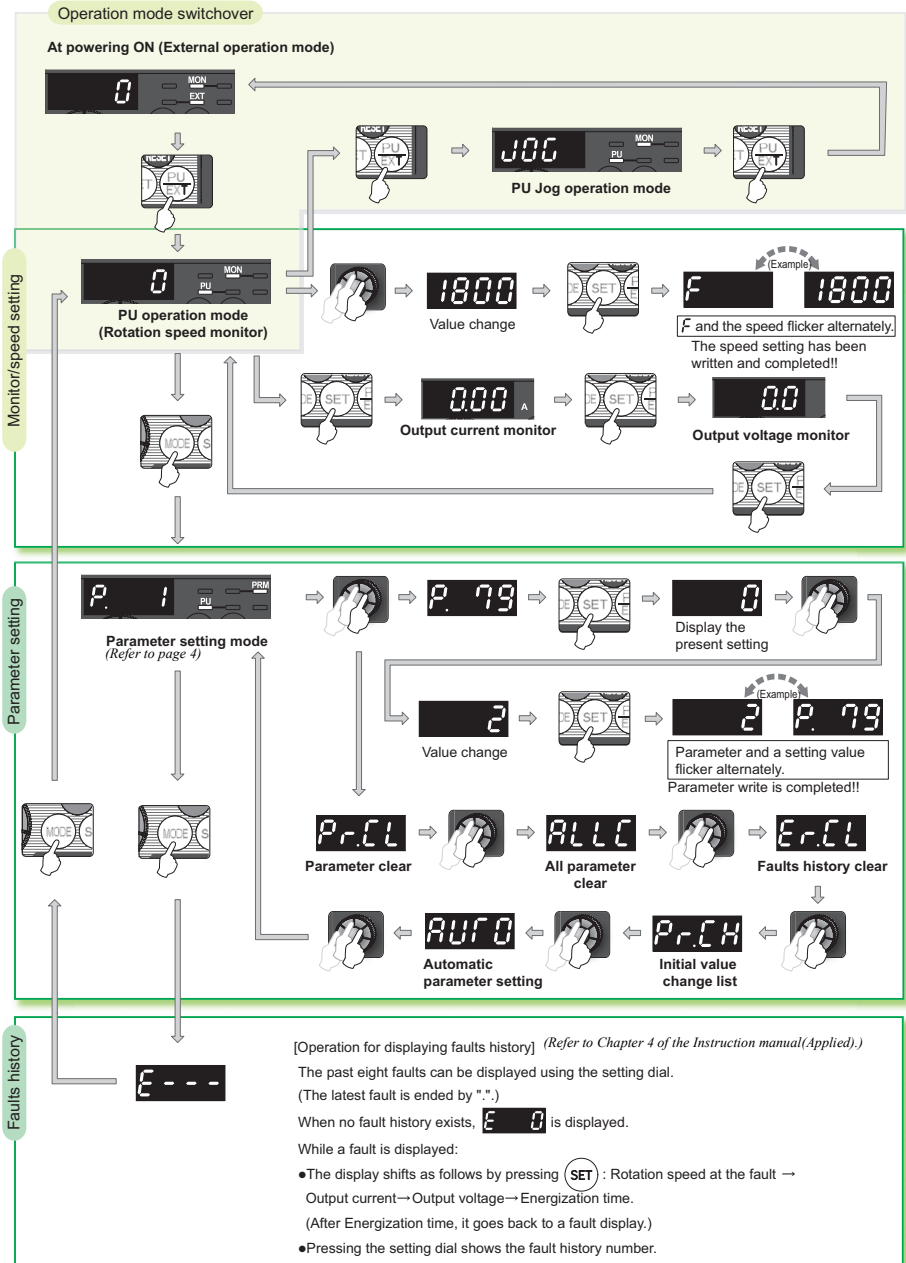

1

1.2.3 Changing the parameter setting value

Changing example Change the Pr. 1 Maximum setting.

Operation

1. Screen at power-ON
The monitor display appears.
2. Changing the operation mode
Press **PU EXT** to choose the PU operation mode. [PU] indicator is lit.
3. Parameter setting mode
Press **MODE** to choose the parameter setting mode.
4. Selecting the parameter number
Turn **▲** until **P. 1** (Pr. 1) appears.
5. Reading the set value
Press **SET** to read the present set value.
"3000"(3000r/min (initial value)) appears.
6. Changing the setting value
Turn **▲** to change the set value to "1800"(1800r/min)
7. Setting the parameter
Press **SET** to set.
The parameter number and the setting value flicker alternately.



REMARKS

? **Er 1** to **Er 4** is displayed...Why?

Er 1 appears Write disable error

Er 2 appears Write error during operation

Er 3 appears Calibration error

Er 4 appears Mode designation error

(For details, refer to the Instruction Manual (Applied).)

The number of digits displayed on the operation panel is four. Only the upper four digits of values can be displayed and set. If the values to be displayed have five digits or more including decimal places, the fifth or later numerals cannot be displayed nor set.

(Example) For Pr. 505

When 60Hz is set, 60.00 is displayed.

When 120Hz is set, 120.0 is displayed and second decimal place is not displayed nor set.

1.2.4 Parameter clear/all parameter clear



POINT

- Set "1" in Pr.CL Parameter clear, ALLC all parameter clear to initialize all parameters. (Parameters are not cleared when "1" is set in Pr. 77 Parameter write selection.)
- Refer to the extended parameter list of the Instruction Manual (Applied) for parameters cleared with this operation.

Operation

1. Screen at power-ON
The monitor display appears.
2. Changing the operation mode
Press **PU EXT** to choose the PU operation mode. [PU] indicator is lit.
3. Parameter setting mode
Press **MODE** to choose the parameter setting mode.
4. Selecting Parameter Clear (All Parameter Clear)
Turn **▲** until **P.r.C.L (ALLC)** appears.
5. Selecting the setting value
Press **SET** to read the present set value.
"0"(initial value) appears.
Turn **▲** to change it to the set value "1".
6. Executing Parameter Clear
Press **SET** to set.
"1" and Pr. CL (ALLC) indications flicker alternately.



REMARKS

? **Er 1** and **Er 4** are displayed alternately ...

Why?

Er 1 The drive unit is not in the PU operation mode.

Er 4 PU connector is used.(Parameter unit (FR-PU07) is in use.)

Setting	Description
0	Clear is not executed.
1	Sets parameters back to the initial values. (Parameter clear sets back all parameters except calibration parameters, terminal function selection parameters to the initial values.) Refer to the parameter list of the Instruction Manual (Applied) for availability of parameter clear and all parameter clear.

2 INSTALLATION AND WIRING



AC power supply
Use within the permissible power supply specifications of the drive unit. To ensure safety, use a moulded case circuit breaker, earth leakage circuit breaker or magnetic contactor to switch power ON/OFF. (Refer to page 38)

Moulded case circuit breaker (MCCB) or earth leakage circuit breaker (ELB), fuse
The breaker must be selected carefully since an in-rush current flows in the drive unit at power on. (Refer to page 6)

Magnetic contactor (MC)
Install the magnetic contactor to ensure safety. Do not use this magnetic contactor to start and stop the drive unit. Doing so will cause the drive unit life to be shortened. (Refer to page 6)

Reactor (FR-HAL, FR-HEL option)
Reactors (option) must be used when power harmonics measures are taken, the power factor is to be improved or the drive unit is installed near a large power supply system (500kVA or more). The drive unit may be damaged if you do not use reactors. Select the reactor according to the model. Remove the jumpers across terminals P/+ and P1 to connect the DC reactor.

AC reactor (FR-HAL)



DC reactor (FR-HEL) *



Noise filter (ferrite core) * (FR-BSF01, FR-BLF)
Install a noise filter (ferrite core) to reduce the electromagnetic noise generated from the drive unit. Effective in the range from about 1MHz to 10MHz. When more wires are passed through, a more effective result can be obtained. A wire should be wound four turns or more.



Parameter unit (FR-PU07)



Enclosure surface operation panel (FR-PA07)
By connecting the connection cable (FR-CB2) to the PU connector, operation can be performed from FR-PU07, FR-PA07.



RS-232C - RS-485 converter is required when connecting to PC with RS-232C interface.
(Refer to the Instruction Manual (Applied))

RS-485 ↔ RS-232C Converter

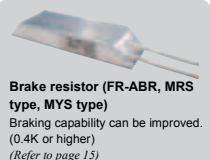

Brake resistor (FR-ABR, MRS type, MYS type)
Braking capability can be improved. (0.4K or higher)
(Refer to page 15)

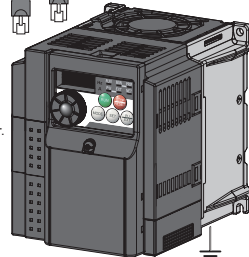

Drive unit (FR-D700-G)

Earth (Ground)

Noise filter (ferrite core) (FR-BSF01, FR-BLF)
Install a noise filter (ferrite core) to reduce the electromagnetic noise generated from the drive unit. Effective in the range from about 1MHz to 10MHz. A wire should be wound four turns at a maximum.



Contactors
Example: No-fuse switch (DSN type)
Install a contactor in an application where the PM motor is driven by the load even at power-OFF of the drive unit. Do not open or close the contactor while the drive unit is running (outputting).

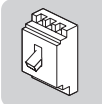

Motor

Earth (Ground)

* Filterpack (FR-BFP2), which contains DC reactor and noise filter in one package, is also available.



High power factor converter (FR-HC)

Power supply harmonics can be greatly suppressed. Install this as required.



Power regeneration common converter (FR-CV)

Great braking capability is obtained. Install this as required.



Resistor unit (FR-BR) Discharging resistor (GZG, GRZG)

The regenerative braking capability of the drive unit can be exhibited fully. Install this as required.

Devices connected to the output

Do not install a power factor correction capacitor, surge suppressor or noise filter (capacitor) on the output side of the drive unit. When installing a moulded case circuit breaker on the output side of the drive unit, contact each manufacturer for selection of the moulded case circuit breaker.

Earth (Ground)

To prevent an electric shock, always earth (ground) the motor and drive unit. For reduction of induction noise from the power line of the drive unit, it is recommended to wire the earth (ground) cable by returning it to the earth (ground) terminal of the drive unit.



NOTE

- The life of the drive unit is influenced by surrounding air temperature. The surrounding air temperature should be as low as possible within the permissible range. This must be noted especially when the drive unit is installed in an enclosure. (Refer to Chapter1 of the Instruction Manual(Applied))
- Wrong wiring might lead to damage of the drive unit. The control signal lines must be kept fully away from the main circuit to protect them from noise. (Refer to page 8)
- Do not install a power factor correction capacitor, surge suppressor or EMC filter (capacitor) on the drive unit output side. This will cause the drive unit to trip or the capacitor and surge suppressor to be damaged. If any of the above devices are connected, immediately remove them.
- Electromagnetic wave interference
The input/output (main circuit) of the drive unit includes high frequency components, which may interfere with the communication devices (such as AM radios) used near the drive unit. In this case, install the FR-BIF optional EMC filter (capacitor) (for use in the input side only) or FR-BSF01 or FR-BLF EMC filter (ferrite core) to minimize interference. (Refer to Chapter 3 of the Instruction Manual (Applied)).
- Refer to the Instruction Manual of each option and peripheral devices for details of peripheral devices.
- A PM motor cannot be driven by the commercial power supply.
- A PM motor is a magnet motor. High-voltage is generated at motor terminals while the motor is running even after the drive unit power is turned OFF. Before closing the contactor at the output side, make sure that the drive unit power is ON and the motor is stopped.

2.1 Peripheral devices

Check the drive unit model of the drive unit you purchased. Appropriate peripheral devices must be selected according to the capacity.

Refer to the following list and prepare appropriate peripheral devices.

Drive unit Model	Motor Output (kW)	Moulded Case Circuit Breaker (MCCB) *1 or Earth Leakage Circuit Breaker (ELB) *2		Magnetic Contactor (MC) *3		Reactor		
		Reactor connection		Reactor connection		FR-HAL	FR-HEL	
		without	with	without	with			
Three-Phase 200V	FR-D720-0.2K-G	0.1	5A	5A	S-N10	S-N10	0.4K *4	0.4K *4
	FR-D720-0.4K-G	0.2	5A	5A	S-N10	S-N10	0.4K *4	0.4K *4
	FR-D720-0.75K-G	0.4	10A	5A	S-N10	S-N10	0.4K	0.4K
	FR-D720-1.5K-G	0.75	15A	10A	S-N10	S-N10	0.75K	0.75K
	FR-D720-2.2K-G	1.5	20A	15A	S-N10	S-N10	1.5K	1.5K
	FR-D720-3.7K-G	2.2	30A	30A	S-N20, S-N21	S-N10	2.2K	2.2K

- *1 •Select a MCCB according to the power supply capacity.
•Install one MCCB per drive unit.
- *2 For the use in the United States or Canada, select a UL and cUL certified fuse with Class T fuse equivalent cut-off speed or faster with the appropriate rating for branch circuit protection. Alternatively, select a UL489 molded case circuit breaker (MCCB). (Refer to page 44)
- *3 Magnetic contactor is selected based on the AC-1 class. The electrical durability of magnetic contactor is 500,000 times. When the magnetic contactor is used for emergency stop during motor driving, the electrical durability is 25 times.
If using an MC for emergency stop during motor driving, select an MC regarding the drive unit input side current as JEM1038-AC-3 class rated current.
- *4 The power factor may be slightly lower.

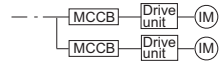

NOTE

- Select a MCCB and a magnetic contactor according to the drive unit model, and cable and reactor according to the motor output.
- When the breaker on the drive unit input side trips, check for the wiring fault (short circuit), damage to internal parts of the drive unit, etc. Identify the cause of the trip, then remove the cause and power ON the breaker.

2.2 Installation of the drive units and precautions

(1) Installation of the drive unit

Enclosure surface mounting

Remove the front cover and wiring cover to mount the drive unit to the surface. (Remove the covers in the directions of the arrows.)

●FR-D720-0.2K to 0.75K-G

●FR-D720-1.5K to 3.7K-G

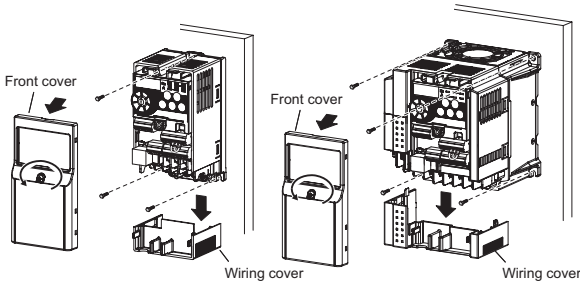

NOTE

- When encasing multiple drive units, install them in parallel as a cooling measure.
- Install the drive unit vertically.
- For heat dissipation and maintenance, allow minimum clearance shown in the figures below from the drive unit to the other devices and to the inner surface of the enclosure.

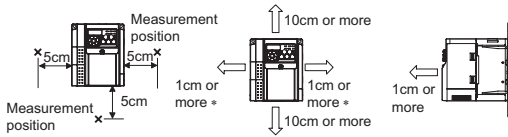

-10°C to +50°C
(non-freezing)

- When using the drive units at the surrounding air temperature of 40°C or less, the drive units can be installed without any clearance between them (0cm clearance).

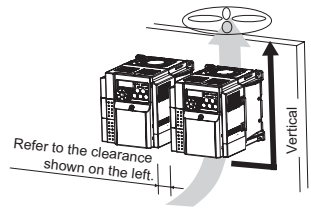

(2) Environment

Before installation, check that the environment meets the specifications on *page 38*.



Note

- Install the drive unit on a strong surface securely and vertically with bolts.
- Leave enough clearances and take cooling measures.
- Avoid places where the drive unit is subjected to direct sunlight, high temperature and high humidity.
- Install the drive unit on a nonflammable wall surface.

2.3 Wiring

2.3.1 Terminal connection diagram

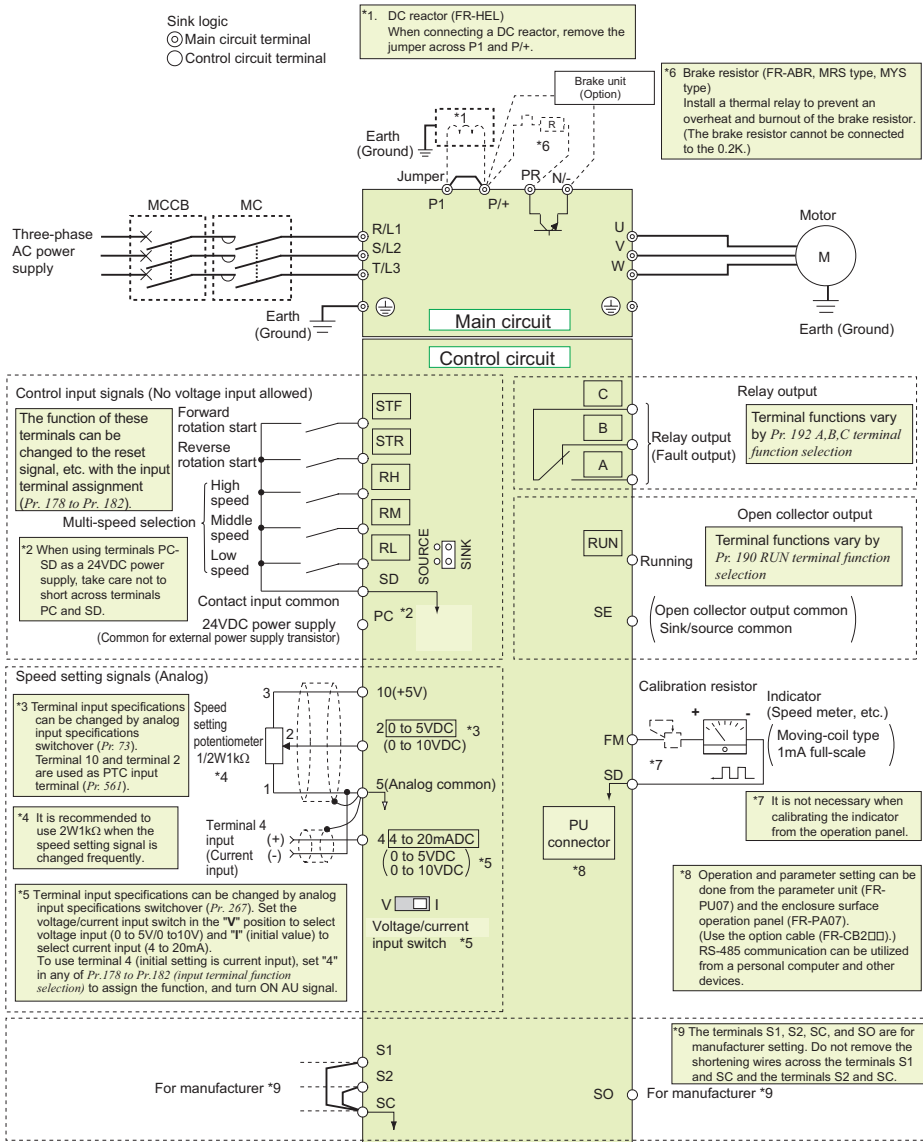

NOTE

- To prevent a malfunction caused by noise, separate the signal cables more than 10cm from the power cables. Also separate the main circuit wire of the input side and the output side.
- After wiring, wire offcuts must not be left in the drive unit. Wire offcuts can cause an alarm, failure or malfunction. Always keep the drive unit clean. When drilling mounting holes in an enclosure etc., take caution not to allow chips and other foreign matter to enter the drive unit.

2.3.2 Terminal specifications

Type	Terminal Symbol	Terminal Name	Terminal Specification			
Main circuit terminal	R/L1, S/L2, T/L3	AC power input	Connect to the commercial power supply. Do not connect anything to these terminals when using the high power factor converter (FR-HC) or power regeneration common converter (FR-CV).			
	U, V, W	Drive unit output	Connect a dedicated PM motor.			
	P/+, PR	Brake resistor connection	Connect a brake resistor (FR-ABR, MRS type, MYS type) across terminals P/+ and PR. (The brake resistor can not be connected to the 0.2K.)			
	P/+, N/-	Brake unit connection	Connect the brake unit (FR-BU2), power regeneration common converter (FR-CV) or high power factor converter (FR-HC).			
	P/+, P1	DC reactor connection	Remove the jumper across terminals P/+ and P1 and connect a DC reactor.			
		Earth (Ground)	For earthing (grounding) the drive unit chassis. Must be earthed (grounded).			
Control circuit terminal/input signal	Contact input	STF	Forward rotation start	Turn ON the STF signal to start forward rotation and turn it OFF to stop.	When the STF and STR signals are turned ON simultaneously, the stop command is given.	
		STR	Reverse rotation start	Turn ON the STR signal to start reverse rotation and turn it OFF to stop.		
		RH, RM, RL	Multi-speed selection	Multi-speed can be selected according to the combination of RH, RM and RL signals.		
		SD	Contact input common (sink) (initial setting)	Common terminal for contact input terminal (sink logic) and terminal FM.		
			External transistor common (source)	Connect this terminal to the power supply common terminal of a transistor output (open collector output) device, such as a programmable controller, in the source logic to avoid malfunction by undesirable current.		
			24VDC power supply common	Common output terminal for 24VDC 0.1A power supply (PC terminal). Isolated from terminals 5 and SE.		
	PC	External transistor common (sink) (initial setting)	Connect this terminal to the power supply common terminal of a transistor output (open collector output) device, such as a programmable controller, in the sink logic to avoid malfunction by undesirable current.			
		Contact input common (source)	Common terminal for contact input terminal (source logic).			
		24VDC power supply	Can be used as 24VDC 0.1A power supply.			
	Speed setting	10	Speed setting power supply	Used as power supply when connecting potentiometer for speed setting (speed setting) from outside of the drive unit.	5VDC permissible load current 10mA	
			Speed setting (voltage)	Inputting 0 to 5VDC (or 0 to 10V) provides the maximum rotation speed at 5V (10V) and makes input and output proportional. Use <i>Pr. 73</i> to switch between input 0 to 5VDC input (initial setting) and 0 to 10VDC.	Input resistance 10kΩ ± 1kΩ Permissible maximum voltage 20VDC	
		4	Speed setting (current)	Inputting 4 to 20mAADC (or 0 to 5V, 0 to 10V) provides the maximum rotation speed at 20mA and makes input and output proportional. This input signal is valid only when the AU signal is ON (terminal 2 input is invalid). To use terminal 4 (initial setting is current input), set "4" in any of <i>Pr.178</i> to <i>Pr.182</i> (input terminal function selection) to assign the function, and turn ON AU signal. Use <i>Pr. 267</i> to switch among input 4 to 20mA (initial setting), 0 to 5VDC and 0 to 10VDC. Set the voltage/current input switch in the "V" position to select voltage input (0 to 5V/0 to 10V).	Current input: Input resistance 249Ω ± 5Ω Maximum permissible current 30mA	
				Voltage input: Input resistance 10kΩ ± 1kΩ Permissible maximum voltage 20VDC		
		5	Speed setting common	Speed setting signal (terminal 2, 4) common terminal. Do not earth (ground).		
	Control circuit terminal/Output signal	Relay	A, B, C	Relay output (fault output)	1 changeover contact output indicates that the drive unit's protective function has activated and the output stopped. Fault: discontinuity across B-C (continuity across A-C). Normal: continuity across B-C (discontinuity across A-C)	
Open collector		RUN	Drive unit running	Switched Low when the drive unit rotation speed is equal to or higher than the 1r/min. Switched High during stop or DC injection brake operation. (Low is when the open collector output transistor is ON (conducts). High is when the transistor is OFF (does not conduct).)	Permissible load 24VDC (maximum 27VDC) 0.1A (a voltage drop is 3.4V maximum when the signal is ON)	
		SE	Open collector output common	Common terminal of terminal RUN.		
Pulse		FM	For meter	Used to output a selected monitored item (such as Rotation speed) among several monitored items. (Not output during drive unit reset.) The output signal is proportional to the magnitude of the corresponding monitored item.	Permissible load current 1mA 1440 pulses/s at 3000r/min	

2

Type	Terminal Symbol	Terminal Name	Terminal Specification
Communication	—	PU connector	With the PU connector, communication can be established through RS-485. <ul style="list-style-type: none"> •Conforming standard: EIA-485 (RS-485) •Transmission format: Multidrop link •Communication speed: 4800 to 38400bps •Overall length: 500m



NOTE

- To change the input specification for terminal 4, set *Pr. 267* and the voltage/current input switch correctly, then input the analog signal relevant to the setting. Applying a voltage with voltage/current input switch in "I" position (current input is selected) or a current with switch in "V" position (voltage input is selected) could cause component damage to the drive unit or analog circuit of output devices.
 - Connecting the power supply to the drive unit output terminals (U, V, W) will damage the drive unit. Do not perform such wiring.
 -  indicates that terminal functions can be selected using *Pr. 178 to Pr. 182, Pr. 190, Pr. 192, Pr. 197 (I/O terminal function selection)*.
 - The terminal names and functions shown here are the initial settings.
 - The terminals S1, S2, SC, and SO are for manufacturer setting. Do not connect anything to these. Doing so may cause a drive unit failure.
- Do not remove the shortening wires across the terminals S1 and SC and the terminals S2 and SC. Removing either of these shortening wires disables the drive unit operation.

2.3.3 Terminal arrangement of the main circuit terminal, power supply and the motor wiring

●Three-phase 200V class

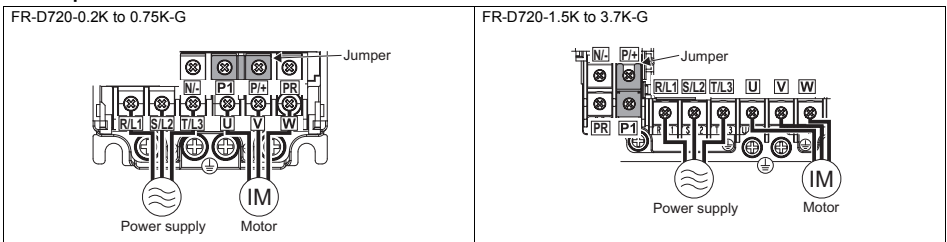

NOTE

- Make sure the power cables are connected to the R/L1, S/L2, T/L3. (Phase need not be matched.) Never connect the power cable to the U, V, W of the drive unit. Doing so will damage the drive unit.
- Connect the motor to U, V, W. Turning ON the forward rotation switch (signal) at this time rotates the motor counterclockwise when viewed from the load shaft.

(1) Cable size and other specifications of the main circuit terminals and the earthing terminal

Select the recommended cable size to ensure that a voltage drop will be 2% or less.

If the wiring distance is long between the drive unit and motor, a main circuit cable voltage drop will cause the motor torque to decrease especially at the output of a low speed.

The following table indicates a selection example for the wiring length of 20m.

Three-phase 200V class (when input power supply is 220V)

Applicable Drive unit Model	Terminal Screw Size ⁺⁴	Tightening Torque N·m	Crimping Terminal		Cable Size							
			R/L1 S/L2 T/L3	U, V, W	HIV Cables, etc. (mm ²) ⁺¹			AWG ⁺²		PVC Cables, etc. (mm ²) ⁺³		
					R/L1 S/L2 T/L3	U, V, W	Earthing (grounding) cable	R/L1 S/L2 T/L3	U, V, W	R/L1 S/L2 T/L3	U, V, W	Earthing (grounding) cable
FR-D720-0.2K to 0.75K-G	M3.5	1.2	2-3.5 2-3.5	2-3.5	2	2	2	14	14	2.5	2.5	2.5
FR-D720-1.5K, 3.7K-G	M4	1.5	2-4	2-4								

- *1 The cable size is that of the cable (HIV cable (600V class 2 vinyl-insulated cable) etc.) with continuous maximum permissible temperature of 75°C. Assumes that the surrounding air temperature is 50°C or less and the wiring distance is 20m or less.
- *2 The recommended cable size is that of the cable (THHW cable) with continuous maximum permissible temperature of 75°C. Assumes that the surrounding air temperature is 40°C or less and the wiring distance is 20m or less. (Selection example for use mainly in the United States.)
- *3 The recommended cable size is that of the cable (PVC cable) with continuous maximum permissible temperature of 70°C. Assumes that the surrounding air temperature is 40°C or less and the wiring distance is 20m or less. (Selection example for use mainly in Europe.)
- *4 The terminal screw size indicates the terminal size for R/L1, S/L2, T/L3, U, V, W, PR, P+, P1 and a screw for earthing (grounding).



NOTE

- Tighten the terminal screw to the specified torque. A screw that has been tightened too loosely can cause a short circuit or malfunction. A screw that has been tightened too tightly can cause a short circuit or malfunction due to the unit breakage.
- Use crimping terminals with insulation sleeve to wire the power supply and motor.

The line voltage drop can be calculated by the following formula:

$$\text{Line voltage drop [V]} = \frac{\sqrt{3} \times \text{wire resistance [m}\Omega/\text{m]} \times \text{wiring distance [m]} \times \text{current [A]}}{1000}$$

Use a larger diameter cable when the wiring distance is long or when it is desired to decrease the voltage drop (torque reduction) in the low speed range.

(2) Total wiring length

Connect a PM motor within the total wiring length of 30m.

Use one dedicated PM motor for one drive unit. Multiple PM motors cannot be connected to a drive unit.



NOTE

- Especially for long-distance wiring, the drive unit may be affected by a charging current caused by the stray capacitances of the wiring, leading to a malfunction of the overcurrent protective function, fast response current limit function, or stall prevention function or a malfunction or fault of the equipment connected on the drive unit output side. If malfunction of fast-response current limit function occurs, disable this function. If malfunction of stall prevention function occurs, increase the stall level. (Refer to Pr. 22 Stall prevention operation level and Pr. 156 Stall prevention operation selection in Chapter 4 of the Instruction Manual (Applied))

2.3.4 Wiring of control circuit

(1) Control circuit terminal layout

Recommend wire size:
0.3mm² to 0.75mm²

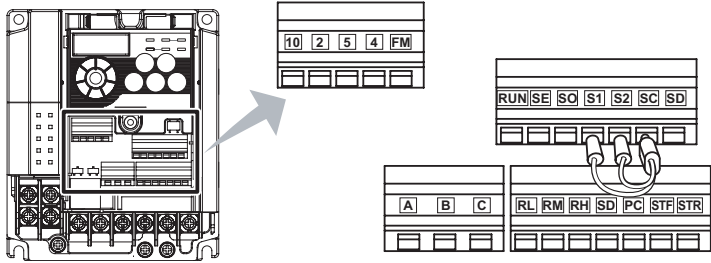

NOTE

Do not remove the shortening wires across the terminals S1 and SC and the terminals S2 and SC. Removing either of these shortening wires disables the drive unit operation.

(2) Wiring method

●Wiring

Use a blade terminal and a wire with a sheath stripped off for the control circuit wiring. For a single wire, strip off the sheath of the wire and apply directly.

Insert the blade terminal or the single wire into a socket of the terminal.

- Strip off the sheath about the length below. If the length of the sheath peeled is too long, a short circuit may occur among neighboring wires. If the length is too short, wires might come off. Wire the stripped wire after twisting it to prevent it from becoming loose. In addition, do not solder it.

Wire stripping length



- Crimp the blade terminal.

Insert wires to a blade terminal, and check that the wires come out for about 0 to 0.5 mm from a sleeve.

Check the condition of the blade terminal after crimping. Do not use a blade terminal of which the crimping is inappropriate, or the face is damaged.

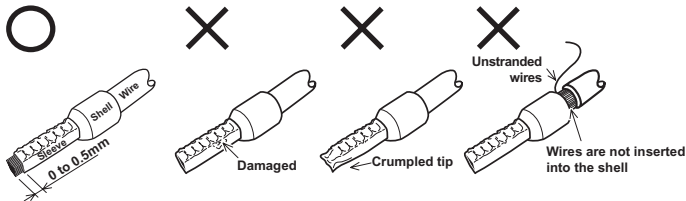

Blade terminals available on the market: (as of February 2012)

●Phoenix Contact Co.,Ltd.

Wire Size (mm ²)	Blade Terminal Model			Crimping Tool Name
	with insulation sleeve	without insulation sleeve	for UL wire *1	
0.3	AI 0,5-10WH	—	—	CRIMPFOX 6
0.5	AI 0,5-10WH	—	AI 0,5-10WH-GB	
0.75	AI 0,75-10GY	A 0,75-10	AI 0,75-10GY-GB	
1	AI 1-10RD	A1-10	AI 1-10RD/1000GB	
1.25, 1.5	AI 1,5-10BK	A1,5-10	AI 1,5-10BK/1000GB *2	
0.75 (for two wires)	AI-TWIN 2 x 0,75-10GY	—	—	

*1 A blade terminal with an insulation sleeve compatible with MTW wire which has a thick wire insulation

*2 Applicable for terminal ABC.

●NICHIFU Co.,Ltd.

Wire Size (mm ²)	Blade terminal product number	Insulation product number	Crimping Tool Product Number
0.3 to 0.75	BT 0.75-11	VC 0.75	NH 69

3) Insert the wire into a socket.

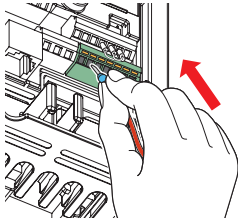

When using a single wire or a stranded wire without a blade terminal, push an open/close button all the way down with a flathead screwdriver, and insert the wire.

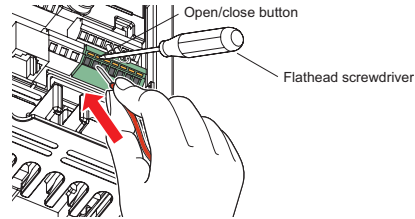

NOTE

- When using a stranded wire without a blade terminal, twist enough to avoid short circuit with a nearby terminals or wires.
- Place the flathead screwdriver vertical to the open/close button. In case the blade tip slips, it may cause damage to drive unit or injury.

●Wire removal

Pull the wire with pushing the open/close button all the way down firmly with a flathead screwdriver.

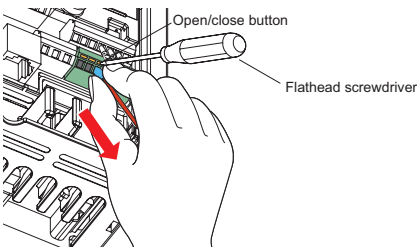

NOTE

- Pulling out the terminal block forcefully without pushing the open/close button all the way down may damage the terminal block.
- Use a small flathead screwdriver (Tip thickness: 0.4mm/ tip width: 2.5mm). If a flathead screwdriver with a narrow tip is used, terminal block may be damaged.

Products available on the market :(as of January 2010)

Product	Type	Maker
Flathead screwdriver	SZF 0- 0,4 x 2,5	Phoenix Contact Co.,Ltd.

- Place the flathead screwdriver vertical to the open/close button. In case the blade tip slips, it may cause damage to drive unit or injury.

(3) Control circuit common terminals (SD, 5, SE)

Terminals SD, SE and 5 are common terminals for I/O signals.(All common terminals are isolated from each other.) Do not earth them. Avoid connecting the terminals SD and 5 and the terminals SE and 5.

Terminal SD is a common terminal for the contact input terminals (STF, STR, RH, RM, RL) and pulse train output terminal (FM). The open collector circuit is isolated from the internal control circuit by photocoupler.

Terminal 5 is a common terminal for the speed setting signals (terminals 2 or 4). It should be protected from external noise using a shielded or twisted cable.

Terminal SE is a common terminal for the open collector output terminal (RUN). The contact input circuit is isolated from the internal control circuit by photocoupler.

(4) Wiring instructions

- 1) It is recommended to use the cables of 0.3mm² to 0.75mm² gauge for connection to the control circuit terminals.
- 2) The maximum wiring length should be 30m (200m for terminal FM).
- 3) Do not short across terminals PC and SD. Drive unit may be damaged.
- 4) Use two or more parallel micro-signal contacts or twin contacts to prevent contact faults when using contact inputs since the control circuit input signals are micro-currents.
- 5) Use shielded or twisted cables for connection to the control circuit terminals and run them away from the main and power circuits (including the 200V relay sequence circuit).
- 6) Do not apply a voltage to the contact input terminals (e.g. STF) of the control circuit.
- 7) Always apply a voltage to the fault output terminals (A, B, C) via a relay coil, lamp, etc.



Micro signal contacts

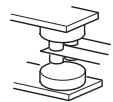

Twin contacts

2.3.5 Assigning signals (output stop signal (MRS), reset signal (RES), etc.) to contact input terminals



POINT

- Use parameters (Pr.178 to Pr.182 input terminal function selection) to select and change the functions assigned to input terminals.
To assign the output stop signal (MRS) to the terminal RH, for example, assign "24" to Pr.182 RH terminal function selection. Refer to page 4 to change the parameter setting.
- Set Pr.160 Extended function display selection = "0" (extended parameters enabled).

Parameter	Name	Unit	Initial value	Range
178	STF terminal function selection	1	60	0: Low-speed operation command (RL) 23: Pre-excitation/servo ON (LX) 1: Middle-speed operation command (RM) 24: Output stop (MRS) 2: High-speed operation command (RH) 25: Start self-holding selection (STOP) 3: Second function selection (RT) 60: Forward rotation command (STF) *1 4: Terminal 4 input selection (AU) 61: Reverse rotation command (STR) *2 5: Jog operation selection (JOG) 62: Drive unit reset (RES) 7: External thermal relay input (OH) 64: PID forward/reverse action switchover (X64) 8: 15-speed selection (REX) 65: PU/NET operation switchover (X65) 10: Drive unit run enable signal (X10) 66: External/NET operation switchover (X66) (FR-HC/FR-CV connection) 67: Command source switchover (X67) 12: PU operation external interlock (X12) 72: PID integral value reset (X72) 14: PID control valid terminal (X14) 9999: No function 16: PU/External operation switchover (X16) *1 Assignable to the STF terminal (Pr.178) only. *2 Assignable to the STR terminal (Pr.179) only.
179	STR terminal function selection	1	61	
180	RL terminal function selection	1	0	
181	RM terminal function selection	1	1	
182	RH terminal function selection	1	2	



NOTE

- Changing the terminal assignment using Pr.178 to Pr.182 (input terminal function selection) may affect other functions. Set parameters after confirming the function of each terminal.

2.4 Connection of a dedicated external brake resistor (MRS type, MYS type, FR-ABR) (0.4K or higher)

Install a dedicated brake resistor (MRS type, MYS type, FR-ABR) outside when the motor driven by the drive unit is made to run by the load, quick deceleration is required, etc. Connect a dedicated brake resistor (MRS type, MYS type, FR-ABR) to terminal P/+ and PR. (For the locations of terminal P/+ and PR, refer to the terminal block layout (page 11).)

Set parameters below. ( Refer to the Instruction Manual (Applied) for the parameter details.)

Connected Brake Resistor	Pr. 30 Regenerative function selection Setting	Pr. 70 Special regenerative brake duty Setting
MRS type, MYS type	0 (initial value)	—
MYS type (used at 100% torque/6%ED)	1	6%
FR-ABR	1	10%

- It is recommended to configure a sequence, which shuts off power in the input side of the drive unit by the external thermal relay as shown below, to prevent overheat and burnout of the brake resistor (MRS type, MYS type) and high duty brake resistor (FR-ABR) in case the regenerative brake transistor is damaged. (The brake resistor cannot be connected to the 0.2K.)

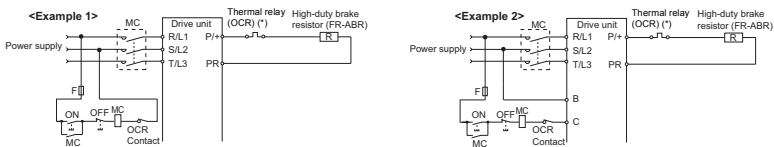

* Refer to the table below for the type number of each capacity of thermal relay and the diagram below for the connection.

Power Supply Voltage	Brake Resistor	Thermal Relay Type (Mitsubishi product)	Contact Rating
200V	MRS120W200	TH-N20CXHZ-0.7A	110VAC 5A, 220VAC 2A(AC11 class) 110VDC 0.5A, 220VDC 0.25A(DC11 class)
	MRS120W100	TH-N20CXHZ-1.3A	
	MRS120W60	TH-N20CXHZ-2.1A	
	MRS120W40	TH-N20CXHZ-3.6A	
	MYS220W50 (two units in parallel)	TH-N20CXHZ-5A	

Power Supply Voltage	High-duty Brake Resistor	Thermal Relay Type (Mitsubishi product)	Contact Rating
200V	FR-ABR-0.4K	TH-N20CXHZ-0.7A	110VAC 5A, 220VAC 2A(AC11 class) 110VDC 0.5A, 220VDC 0.25A(DC11 class)
	FR-ABR-0.75K	TH-N20CXHZ-1.3A	
	FR-ABR-2.2K	TH-N20CXHZ-2.1A	
	FR-ABR-3.7K	TH-N20CXHZ-3.6A	

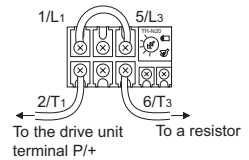

NOTE

- The brake resistor connected should only be the dedicated brake resistor.
- Perform wiring and operation according to the Instruction Manual of each option unit.
- Brake resistor cannot be used with the brake unit, high power factor converter, power supply regeneration converter, etc.
- Do not use the brake resistor(MRS type, MYS type) with a lead wire extended.
- Do not connect a resistor directly to terminals P/+ and N/-. This could cause a fire.

3 PRECAUTIONS FOR USE OF THE DRIVE UNIT

The FR-D700-G series is a highly reliable product, but incorrect peripheral circuit making or operation/handling method may shorten the product life or damage the product.

Before starting operation, always recheck the following items.

- (1) **Use crimping terminals with insulation sleeve to wire the power supply and motor.**
- (2) **Application of power to the output terminals (U, V, W) of the drive unit will damage the drive unit. Never perform such wiring.**
- (3) **After wiring, wire offcuts must not be left in the drive unit.**

Wire offcuts can cause an alarm, failure or malfunction. Always keep the drive unit clean.
When drilling mounting holes in an enclosure etc., take care not to allow chips and other foreign matter to enter the drive unit.
- (4) **Use cables of the size to make a voltage drop 2% or less.**

If the wiring distance is long between the drive unit and motor, a main circuit cable voltage drop will cause the motor torque to decrease especially at the output of a low speed. Refer to *page 14* for the recommended wire sizes.
- (5) **The overall wiring length should be 30m or less.**

Especially for long distance wiring, or the equipment connected to the output side may malfunction or become faulty under the influence of a charging current due to the stray capacity of the wiring. Therefore, note the overall wiring length.
(Refer to *page 15*)
- (6) **Electromagnetic wave interference**

The input/output (main circuit) of the drive unit includes high frequency components, which may interfere with the communication devices (such as AM radios) used near the drive unit. In this case, install the FR-BIF optional capacitor type filter (for use in the input side only) or FR-BSF01 or FR-BLF line noise filter to minimize interference.
- (7) **Do not install a power factor correction capacitor, surge suppressor or capacitor type filter on the drive unit output side.**

This will cause the drive unit to trip or the capacitor and surge suppressor to be damaged. If any of the above devices are connected, immediately remove them.
- (8) **For some short time after the power is switched OFF, a high voltage remains in the smoothing capacitor.**

When accessing the drive unit for inspection, wait for at least 10 minutes after the power supply has been switched OFF, and then make sure that the voltage across the main circuit terminals P/+ and N/- of the drive unit is not more than 30VDC using a tester, etc.
- (9) **A short circuit or earth (ground) fault on the drive unit output side may damage the drive unit module.**
 - Fully check the insulation resistance of the circuit prior to drive unit operation since repeated short circuits caused by peripheral circuit inadequacy or an earth (ground) fault caused by wiring inadequacy or reduced motor insulation resistance may damage the drive unit module.
 - Fully check the to-earth (ground) insulation and phase to phase insulation of the drive unit output side before power-On.
Especially for an old motor or use in hostile atmosphere, securely check the motor insulation resistance etc.
- (10) **Do not use the drive unit input side magnetic contactor to start/stop the drive unit.**

Since repeated inrush currents at power ON will shorten the life of the converter circuit (switching life is about 1,000,000 times.), frequent starts and stops of the MC must be avoided. Turn ON/OFF the drive unit start controlling terminals (STF, STR) to run/stop the drive unit. (📖 Refer to the Instruction Manual (Applied))
- (11) **Across terminals P/+ and PR, connect only an external brake resistor.**
 - Do not connect a mechanical brake.
 - The brake resistor cannot be connected to the 0.2K. Do not connect anything to terminals P/+ and PR.
Also, never short between these terminals.

- (12) Do not apply a voltage higher than the permissible voltage to the drive unit I/O signal circuits.**
Application of a voltage higher than the permissible voltage to the drive unit I/O signal circuits or opposite polarity may damage the I/O devices. Especially check the wiring to prevent the speed setting potentiometer from being connected incorrectly to short terminals 10 and 5.
- (13) If the machine must not be restarted when power is restored after a power failure, provide a magnetic contactor in the drive unit's input side and also make up a sequence which will not switch ON the start signal.**
If the start signal (start switch) remains ON after a power failure, the drive unit will automatically restart as soon as the power is restored.
- (14) Drive unit input side magnetic contactor (MC)**
On the drive unit input side, connect a MC for the following purposes. (Refer to *page 6* for selection.)
- 1) To release the drive unit from the power supply when a fault occurs or when the drive is not functioning (e.g. emergency stop operation). For example, MC avoids overheat or burnout of the brake resistor when heat capacity of the resistor is insufficient or brake regenerative transistor is damaged with short while connecting an optional brake resistor.
 - 2) To prevent any accident due to an automatic restart at restoration of power after a drive unit stop made by a power failure
 - 3) To separate the drive unit from the power supply to ensure safe maintenance and inspection work.
- If using an MC for emergency stop during operation, select an MC regarding the drive unit input side current as JEM1038-AC-3 class rated current.
- (15) Handling of drive unit output side magnetic contactor**
Switch the magnetic contactor between the drive unit and motor only when both the drive unit and motor are at a stop. When the magnetic contactor is turned ON while the drive unit is operating, overcurrent protection of the drive unit and such will activate.
- (16) Countermeasures against drive unit-generated EMI**
If electromagnetic noise generated from the drive unit causes speed setting signal to fluctuate and motor rotation speed to be unstable when changing motor speed with analog signal, the following countermeasures are effective.
- Do not run the signal cables and power cables (drive unit I/O cables) in parallel with each other and do not bundle them.
 - Run signal cables as far away as possible from power cables (drive unit I/O cables).
 - Use shield cables as signal cables.
 - Install a ferrite core on the signal cable (Example: ZCAT3035-1330 TDK).
- (17) Instructions for overload operation**
When performing operation of frequent start/stop of the drive unit, rise/fall in the temperature of the transistor element of the drive unit will repeat due to a repeated flow of large current, shortening the life from thermal fatigue. Since thermal fatigue is related to the amount of current, the life can be increased by reducing current at locked condition, starting current, etc. Decreasing current may increase the life. However, decreasing current will result in insufficient torque and the drive unit may not start. Reducing the current may extend the service life but may also cause torque shortage, which leads to a start failure. An effective measure is to use a drive unit and motor with higher capacities. Doing so will provide a margin to the load.
- (18) Make sure that the specifications and rating match the system requirements.**

4 FAILSAFE OF THE SYSTEM WHICH USES THE DRIVE UNIT

When a fault occurs, the drive unit trips to output a fault signal. However, a fault output signal may not be output at a drive unit fault occurrence when the detection circuit or output circuit fails, etc. Although Mitsubishi assures best quality products, provide an interlock which uses drive unit status output signals to prevent accidents such as damage to machine when the drive unit fails for some reason and at the same time consider the system configuration where failsafe from outside the drive unit, without using the drive unit, is enabled even if the drive unit fails.

(1) Interlock method which uses the drive unit status output signals

By combining the drive unit status output signals to provide an interlock as shown below, a drive unit failure can be detected.

No.	Interlock Method	Check Method	Used Signals	Refer to Page
1)	Drive unit protective function operation	Operation check of an alarm contact Circuit error detection by negative logic	Fault output signal (ALM signal)	<i>Refer to Chapter 4 of the Instruction Manual (Applied).</i>
2)	Drive unit operating status	Operation ready signal check	Operation ready signal (RY signal)	<i>Refer to Chapter 4 of the Instruction Manual (Applied).</i>
3)	Drive unit running status	Logic check of the start signal and running signal	Start signal (STF signal, STR signal) Running signal (RUN signal)	<i>Refer to Chapter 4 of the Instruction Manual (Applied).</i>
4)	Drive unit running status	Logic check of the start signal and output current	Start signal (STF signal, STR signal) Output current detection signal (Y12 signal)	<i>Refer to Chapter 4 of the Instruction Manual (Applied).</i>

(2) Backup method outside the drive unit

Even if the interlock is provided by the drive unit status signal, enough failsafe is not ensured depending on the failure status of the drive unit itself. For example, when the drive unit CPU fails, even if the interlock is provided using the drive unit fault signal, start signal and RUN signal, there is a case where a fault signal is not output and RUN signal is kept output even if a drive unit fault occurs.

Provide a speed detector to detect the motor speed and current detector to detect the motor current and consider the backup system such as checking up as below according to the level of importance of the system.

1) Start signal and actual operation check

Check the motor running and motor current while the start signal is input to the drive unit by comparing the start signal to the drive unit and detected speed of the speed detector or detected current of the current detector. Note that the motor current runs as the motor is running for the period until the motor stops since the drive unit starts decelerating even if the start signal turns OFF. For the logic check, configure a sequence considering the drive unit deceleration time. In addition, it is recommended to check the three-phase current when using the current detector.

2) Command speed and actual operation check

Check if there is no gap between the actual speed and commanded speed by comparing the drive unit speed command and detected speed of the speed detector.

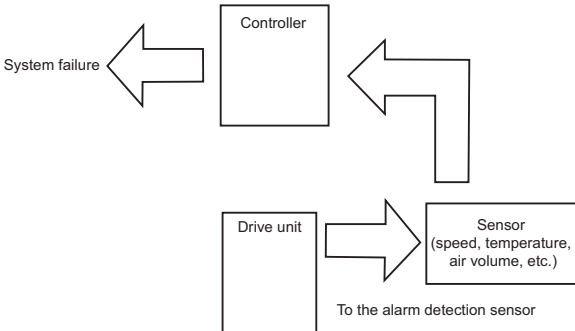

5 DRIVE THE MOTOR

The drive unit needs a speed command and a start command.

Speed command (set speed) determines the rotation speed of the motor. Turning ON the start command starts the motor to rotate.

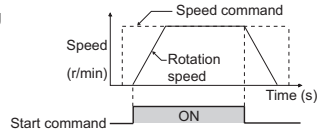

REMARKS

- Set the required parameters according to the load and operating conditions. (Refer to page 27.)

5.1 Start/stop from the operation panel (PU operation)



POINT

From where is the speed command given?

- Operation at the speed set in the speed setting mode of the operation panel (Refer to 5.1.1 (Refer to page 19))
- Operation using the setting dial as the potentiometer (Refer to 5.1.2 (Refer to page 20))
- Change of speed with ON/OFF switches connected to terminals (Refer to 5.1.3 (Refer to page 21))
- Perform speed setting using voltage input signal (Refer to 5.1.4 (Refer to page 22))
- Perform speed setting using current input signal (Refer to 5.1.4 (Refer to page 22))

5.1.1 Setting the speed by the operation panel

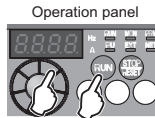

Operation example Operate at 900r/min.

Operation

1. Screen at power-ON

The monitor display appears.

2. Operation mode change

Press **PU/EXT** to choose the PU operation mode. [PU] indicator is lit.

Speed setting

Turn **SET** to show the speed "900" (900r/min) you want to set. The speed flickers for about 5s. While the value is

3. flickering, press **SET** to set the speed. "F" and "900" flicker alternately. After about 3s of flickering, the indication of the value goes back to "0" (monitor display). (If **SET** is not pressed, the indication of the value goes back to "0" after about 5s of flickering. In that case, turn **SET** again, and set the speed.)

Start → acceleration → constant speed

4. Press **RUN** to start operation.

The speed value on the indication increases in Pr. 7 Acceleration time, and "900" (900r/min) appears. (To change the set speed, perform the operation in above step 3. Starting from the previously set speed.)

Deceleration → stop

5. Press **STOP/RESET** to stop. The speed value on the display decreases in Pr. 8 Deceleration time, and the motor stops rotating with "0" (0r/min) displayed.



REMARKS

- **SET** can also be used like a potentiometer to perform operation. (Refer to Chapter 4 of the Instruction Manual (Applied).)
- When you always operate in the PU operation mode at power-ON, set Pr.79 Operation mode selection = "1" to choose the PU operation mode always.

5.1.2 Using the setting dial like a potentiometer to perform operation







POINT

- Set "0" (extended parameter valid) in *Pr. 160 Extended function display selection*.
- Set "1" (setting dial potentiometer mode) in *Pr. 161 Speed setting/key lock operation selection*.

Operation example Change the speed from 0r/min to 1800r/min during operation

Operation

1.	Screen at power-ON The monitor display appears.
2.	Operation mode change Press  to choose the PU operation mode. PU indicator is lit.
3.	Selecting the setting dial mode Change the <i>Pr. 160</i> setting to "0" and the <i>Pr. 161</i> setting to "1". (Refer to page 4 for change of the setting.)
4.	Start Press  to start the speed.
5.	Speed setting Turn  until "1800" (1800/min) appears. The flickering speed is the set speed. You need not press  .



REMARKS

- If flickering "1800" turns to "0", the *Pr. 161 Speed setting/key lock operation selection* setting may not be "1".
- Independently of whether the drive unit is running or at a stop, the speed can be set by merely turning the .



NOTE

- When setting speed by turning setting dial, the speed goes up to the set value of *Pr. 1 Maximum setting* (initial value: 3000r/min). Adjust *Pr. 1 Maximum setting* setting according to the application.

5.1.3 Setting the speed by switches (three-speed setting) (Pr. 4 to Pr. 6)



POINT





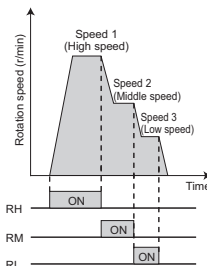
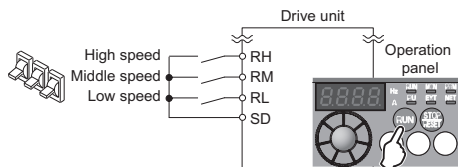







- Use operation panel () to give a start command.
- Switch ON the RH, RM, or RL signal to give a speed command.
- Set "4" (External/PU combined operation mode 2) in Pr. 79 Operation mode selection.

[Connection diagram]



Operation example Operation at low speed (300r/min)

Operation

- Screen at power-ON
The monitor display appears.
- Easy operation mode setting
Press  and  for 0.5s. "  - - " appears, and the [PRM] indicator flickers.
- Operation mode selection
Turn  until "  - 4 " appears. [PU] and [PRM] indicators flicker.
- Operation mode setting
Press  to enter the setting. (Set "4" in Pr: 79.)
"  - 4 " and "  - - " flicker alternately. [PU] and [EXT] indicators are lit.
- Speed setting
Turn ON the low-speed switch (RL).
Start → acceleration → constant speed
- Press  to start running.
The speed value on the indication increases in Pr: 7 Acceleration time, and "  " (300r/min) appears.
[RUN] indicator is lit during forward rotation operation and flickers slowly during reverse rotation operation.
- Deceleration → stop
Press  to stop.
The speed value on the indication decreases in Pr: 8 Deceleration time, and the motor stops rotating with "  " (0r/min) displayed.
- Speed setting (OFF)
Turn OFF the low-speed switch (RL).



REMARKS

- The initial values of the terminals RH, RM, RL are 3000r/min, 1500r/min, and 300r/min. (Use Pr: 4, Pr: 5 and Pr: 6 to change.)
- In the initial setting, when two or three of multi-speed settings are simultaneously selected, priority is given to the set speed of the lower signal.
For example, when the RH and RM signals turn ON, the RM signal (Pr: 5) has a higher priority.
- Maximum of 15-speed operation can be performed. ( Refer to Chapter 4 of the Instruction Manual (Applied).)

5.1.4 Setting the speed by analog input (voltage input/current input)



POINT

- Use the operation panel (**RUN**) to give a start command.
- Use the (speed setting) potentiometer (voltage input) or 4-to-20mA input (current input) to give a speed command.
- Set "4" (External/PU combined operation mode 2) in Pr. 79 Operation mode selection.

[Connection example for voltage input]

(The drive unit supplies 5V power to the speed setting potentiometer. (terminal 10))

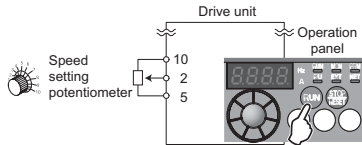

[Connection example for current input]

Assign the AU signal in one of Pr. 178 to Pr. 182.

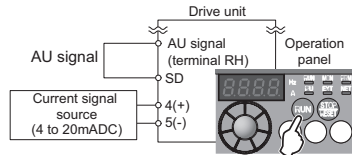

Operation example Operate at 3000r/min.

Operation

- Screen at power-ON
The monitor display appears.
- Assignment of the AU signal (current input) (Refer to the step 3 for voltage input.)
Set Pr. 160 to "0" to activate extended parameters.
To assign the AU signal, set "4" in one of Pr. 178 to Pr. 182. (Refer to page 4 to change the setting.)
Turn ON the AU signal.
- Easy operation mode setting
Press **PU/EXT** and **MODE** for 0.5s. "79 - -" appears, and the [PRM] indicator flickers.
- Operation mode selection
Turn **SEL** until "79 - 4" appears. [PU] and [PRM] indicators flicker.
- Operation mode setting
Press **SET** to enter the setting. (Set "4" in Pr.79.)
"79 - 4" and "79 - -" flicker alternately. [PU] and [EXT] indicators are lit.
- Start
Press **RUN**. [RUN] flickers fast as no speed command is given.
- Acceleration → constant speed
For voltage input, turn the potentiometer (speed setting potentiometer) clockwise slowly to full.
For current input, input 20mA.
The speed value on the display increases in Pr. 7 Acceleration time, and "3000" (3000r/min) appears.
[RUN] indicator is lit during forward rotation operation and flickers slowly during reverse rotation operation.
- Deceleration
For voltage input, turn the potentiometer (speed setting potentiometer) counterclockwise slowly to full.
For current input, input 4mA.
The speed value on the display decreases in Pr. 8 Deceleration time, and the motor stops rotating with "0" (0r/min) displayed.
[RUN] flickers fast.
- Stop
Press **STOP/RESET**. [RUN] indicator turns OFF.



REMARKS





- The speed at the full clockwise turn of the potentiometer (speed setting potentiometer) (maximum potentiometer setting) is 3000r/min in the initial setting. (To change the setting, use Pr.125.) (Refer to page 26.)
- For current input, the speed at 20mA input is 3000r/min in the initial setting. (To change the setting, use Pr. 126.) (Refer to Chapter 4 of the Instruction Manual (Applied).)
- To input 10VDC to the terminal 2, set Pr. 73 Analog input selection = "0". The initial value is "1 (0 to 5V input)" (Refer to Chapter 4 of the Instruction Manual (Applied).)
- To use the terminal 4 (4 to 20mA), assign "4 (AU signal)" to one of Pr.178 to Pr.182 (input terminal function selection), and turn the AU signal ON.

5.2 Start and stop using terminals (External operation)



POINT

From where is the speed command given?

- Operation at the speed set in the speed setting mode of the operation panel  refer to 5.2.1 (Refer to page 23)
- Give a speed command by switch (multi-speed setting)  refer to 5.2.2 (Refer to page 24)
- Perform speed setting by a voltage input signal  refer to 5.2.3 (Refer to page 25)
- Perform speed setting by a current input signal   refer to 5.2.3 (Refer to page 25)

5.2.1 Setting the speed by the operation panel (Pr. 79 = 3)



POINT





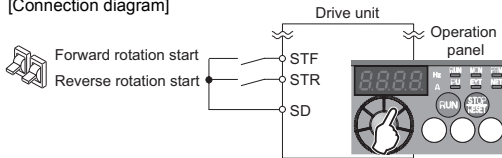



- Switch ON the STF(STR) signal to give a start command.
- Use the operation panel () to give a speed command.
- Set "3" (External/PU combined operation mode 1) in Pr. 79.

[Connection diagram]



Operation example Operate at 900r/min.

Operation

1. Screen at power-ON
The monitor display appears.
2. Easy operation mode setting
Press  and  for 0.5s. "79 - -" appears, and the [PRM] indicator flickers.
3. Operation mode selection
Turn  until "79 - 3" appears. [EXT] and [PRM] indicators flicker.
4. Operation mode setting
Press  to enter the setting. (Set "3" in Pr. 79.)
"79 - 3" and "79 - -" flicker alternately. [PU] and [EXT] indicators are lit.
5. Speed setting
Turn  to show the speed "900" you want to set. The speed flickers for about 5s. While the value is flickering, press  to set the speed. "F" and "900" flicker alternately. After about 3s of flickering, the indication of the value goes back to "0" (monitor display). (If  is not pressed, the indication of the value goes back to "0" (0r/min) after about 5s of flickering.
In that case, turn  again, and set the speed.)
6. Start → acceleration → constant speed
Turn the start switch (STF or STR) ON.
The speed value on the display increases in Pr. 7 Acceleration time, and "900" (900r/min) appears.
[RUN] indicator is lit during forward rotation operation and flickers during reverse rotation operation.
(To change the set speed, perform the operation in above step 5. Starting from the previously set speed.)
7. Deceleration → stop
Turn OFF the start switch (STF or STR). The speed value on the indication decreases in Pr. 8 Deceleration time, and the motor stops rotating with "0" (0r/min) displayed. [RUN] turns OFF.

5.2.2 Setting the speed by switches (three-speed setting) (Pr. 4 to Pr. 6)



POINT

- Switch ON the STF (STR) signal to give a start command.
- Switch ON the RH, RM, or RL signal to give a speed command.

[Connection diagram]

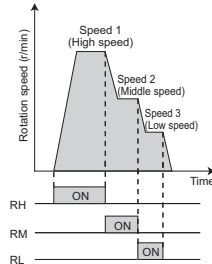
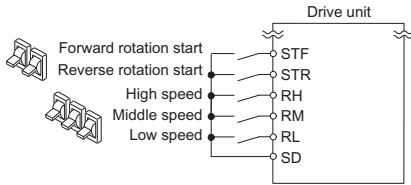

Operation example Operation at high speed (3000r/min)

Operation

1. Screen at power-ON
The monitor display appears.
2. Speed setting
Turn ON the high-speed switch (RH).
Start → Acceleration → constant speed
Turn ON the start switch (STF or STR). The speed value on the indication increases in *Pr. 7 Acceleration time*, and "3000" (3000r/min) appears.
[RUN] indicator is lit during forward rotation operation and flickers during reverse rotation operation.
• When RM is turned ON, 1500r/min is displayed. When RL is turned ON, 300r/min is displayed.
- Deceleration → Stop
4. Turn OFF the start switch (STF or STR). The speed value on the indication decreases in *Pr. 8 Deceleration time*, and the motor stops rotating with "0" (0r/min) displayed. [RUN] turns OFF.
5. Speed setting(OFF)
Turn OFF the high-speed switch (RH)



REMARKS

- Initial values of terminals RH, RM, RL are 3000r/min, 1500r/min, and 300r/min. (To change, set *Pr. 4*, *Pr. 5* and *Pr. 6*.)
- In the initial setting, when two or three of multi-speed settings are simultaneously selected, priority is given to the set speed of the lower signal.
For example, when the RH and RM signals turn ON, the RM signal (*Pr. 5*) has a higher priority.
- Maximum of 15-speed operation can be performed. (Refer to Chapter 4 of the Instruction Manual (Applied).)

5.2.3 Setting the speed by analog input (voltage input/current input)



POINT

- Turn ON the STF(STR) signal to give a start command.
- Use the potentiometer (speed setting potentiometer) (voltage input) or 4-to-20mA input (current input) to give a speed command.

[Connection example for voltage input]

(The drive unit supplies 5V power to the speed setting potentiometer. (terminal 10))

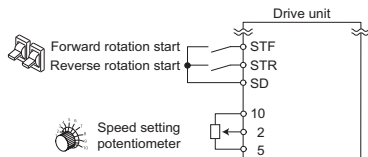

Operation example Operate at 3000r/min.

[Connection example for current input]

Assign the AU signal in one of Pr. 178 to Pr. 182.

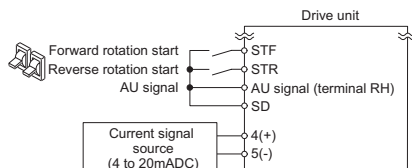

Operation

- 1. Screen at power-ON**
The monitor display appears.
- Assignment of the AU signal (current input) (Refer to the step 3 for voltage input.)**
Set Pr. 160 to "0" to activate extended parameters.
To assign the AU signal, set "4" in one of Pr. 178 to Pr. 182. (Refer to page 4 to change the setting.)
Turn ON the AU signal.
- Start**
Turn the start switch (STF or STR) ON.
[RUN] flickers fast because the speed command is not given.
- Acceleration → constant speed**
For voltage input, turn the potentiometer (speed setting potentiometer) clockwise slowly to full.
For current input, input 20mA.
The speed value on the display increases in Pr. 7 Acceleration time, and "3000" (3000r/min) appears.
[RUN] indicator is lit during forward rotation operation and flickers slowly during reverse rotation operation.
- Deceleration**
For voltage input, turn the potentiometer (speed setting potentiometer) counterclockwise slowly to full.
For current input, input 4mA.
The speed value on the display decreases in Pr. 8 Deceleration time, and the motor stops rotating with "0" (0r/min) displayed.
[RUN] flickers fast.
- Stop**
Turn the start switch (STF or STR) OFF.
[RUN] turns OFF.



REMARKS

- For voltage input, the speed (maximum potentiometer setting) at the full right turn of the (speed setting) potentiometer is 3000r/min in the initial setting. (To change the setting, use Pr.125.) (Refer to page 26.)
- For current input, the speed at 20mA input is 3000r/min in the initial setting. (To change the setting, use Pr. 126.) (Refer to Chapter 4 of the Instruction Manual (Applied).)
- To input 10VDC to the terminal 2, set Pr.73 Analog input selection = "0". The initial value is "1 (0 to 5V input)". (Refer to Chapter 4 of the Instruction Manual (Applied).)
- To always select the External operation mode, set Pr. 79 Operation mode selection = "2 (External operation mode)".
- To use the terminal 4 (4 to 20mA), assign "4 (AU signal)" to one of Pr.178 to Pr.182 (input terminal function selection), and turn the AU signal ON.





5.2.4 Setting the speed at the maximum potentiometer indication

< How to change the maximum speed >

Changing example

When you want to use 0 to 5VDC input speed setting potentiometer to change the speed at 5V from 3000r/min (initial value) to 2100r/min, make adjustment to output "2100r/min" at 5V voltage input. Set "2100r/min" in Pr. 125.

Operation

Parameter selection	
1.	Turn  until "P. 125" (Pr. 125) appears. Press  to show the present set value "3000" (3000r/min).
Changing the maximum speed	
2.	Turn  to change the set value to "2100" (2100r/min). Press  to enter. "2100" and "P. 125" flicker alternately.
Mode/monitor check	
3.	Press  twice to choose the monitor/speed monitor.
Start	
4.	Turn the start switch (STF or STR) ON. [RUN] flickers fast because the speed command is not given.
Acceleration → constant speed	
5.	Turn the potentiometer (speed setting potentiometer) clockwise slowly to full. The speed value on the display increases in Pr. 7 Acceleration time, and "2100" (2100r/min) appears. [RUN] indicator is lit during forward rotation operation and flickers slowly during reverse rotation operation.
Deceleration	
6.	Turn the potentiometer (speed setting potentiometer) counterclockwise slowly to full. The speed value on the display decreases in Pr. 8 Deceleration time, and the motor stops rotating with "0" (0r/min) displayed. [RUN] flickers fast.
Stop	
7.	Turn the start switch (STF or STR) OFF. [RUN] turns OFF.

REMARKS

- Use calibration parameter C2 to set speed at 0V and calibration parameter C0 to adjust the meter.

() Refer to Chapter 4 of the Instruction Manual (Applied).

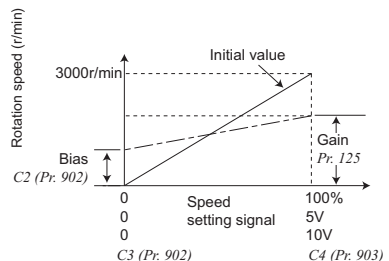

- To input 10VDC to the terminal 2, set Pr.73 Analog input selection = "0". The initial value is "1 (0 to 5V input)".

() Refer to Chapter 4 of the Instruction Manual (Applied).





- As other adjustment methods of speed setting voltage gain, there are methods to adjust with a voltage applied to across terminals 2 and 5 and a method to adjust at any point without a voltage applied. () Refer to Chapter 4 of the Instruction Manual (Applied) for the setting method of calibration parameter C4.)

? Change the speed (3000r/min) at the maximum current input (20mA in the initial setting)

 Adjust it with Pr.126 Terminal 4 speed setting gain speed. () Refer to Chapter 4 of the Instruction Manual (Applied).

? Change the speed (0r/min) at the minimum current input (4mA in the initial setting)

 Adjust with the calibration parameter C5 Terminal 4 speed setting bias speed. () Refer to Chapter 4 of the Instruction Manual (Applied).

6 PARAMETERS

Simple variable-speed operation can be performed with the drive unit in the initial settings. Set the required parameters according to the load and operating conditions. Use the operation panel to set or change a parameter. (Refer to  Chapter 4 of the Instruction Manual (Applied) for the detailed description of parameters.

6.1 Simple mode parameters



POINT

In the initial setting, only the simple mode parameters are displayed by the Pr.160 Extended function display selection setting. Change the Pr.160 Extended function display selection setting as required. (Refer to page 4 to change the parameter.

Parameter Number	Name	Increments	Initial Value	Range	Application
1	Maximum setting	1r/min	3000r/min	0 to 12000r/min/ 0 to 8000r/min *	Use this parameter to set the upper limit for the rotation speed.
2	Minimum setting	1r/min	0r/min	0 to 3600r/min/ 0 to 2400r/min *	Use this parameter to set the lower limit for the rotation speed.
4	Multi-speed setting (high speed)	1r/min	3000r/min	0 to 12000r/min/ 0 to 8000r/min *	Use these parameters to change among pre-set operation speeds with the terminals. The speeds are pre-set with parameters.
5	Multi-speed setting (middle speed)	1r/min	1500r/min	0 to 12000r/min/ 0 to 8000r/min *	
6	Multi-speed setting (low speed)	1r/min	300r/min	0 to 12000r/min/ 0 to 8000r/min *	
7	Acceleration time	0.1s	5s	0 to 3600s	Use these parameters to set the acceleration/ deceleration time.
8	Deceleration time	0.1s	5s	0 to 3600s	
9	Electronic thermal O/L relay	0.01A	Rated motor current	0 to 500A	With this parameter, the drive unit protects the motor from heat. Set the rated motor current.
79	Operation mode selection	1	0	0	External/PU switchover mode
				1	Fixed to PU operation mode
				2	Fixed to External operation mode
				3	External/PU combined operation mode 1 (Start command from External, speed command from PU)
				4	External/PU combined operation mode 2 (Speed command from External, start command from PU)
				6	Switchover mode
				7	External operation mode (PU operation interlock)
125	Terminal 2 speed setting gain speed	1r/min	3000r/min	0 to 12000r/min/ 0 to 8000r/min *	Use this parameter to change the speed at the maximum potentiometer setting (5V in the initial setting)
126	Terminal 4 speed setting gain speed	1r/min	3000r/min	0 to 12000r/min/ 0 to 8000r/min *	Use this parameter to change the speed at the maximum current input (20mA in the initial setting)
160	Extended function display selection	1	9999	0	Simple mode + extended mode parameters are displayed.
				9999	Only the simple mode parameters are displayed.
999	Automatic parameter setting	1	9999	10, 9999	Communication parameter settings for Mitsubishi's human machine interface (GOT) connection are changed as a batch.
Pr.CL	Parameter clear	1	0	0, 1	Setting "1" returns all parameters except calibration parameters to the initial values.
ALLC	All parameter clear	1	0	0, 1	Setting "1" returns all parameters to the initial values.
Er.CL	Fault history clear	1	0	0, 1	Setting "1" clears eight past faults.
Pr.CH	Initial value change list	—	—	—	Displays and sets the parameters changed from the initial value.
AUTO	Automatic parameter setting	—	—	—	Communication parameter settings for Mitsubishi's human machine interface (GOT) connection are changed as a batch.

* Range depends on the drive unit capacity. (0.2K to 2.2K/3.7K)

6.2 Parameter list



REMARKS

- ● indicates simple mode parameters.
- The parameters surrounded by a black border in the table allow its setting to be changed during operation even if "0" (initial value) is set in Pr. 77 Parameter write selection.

Parameter	Name	Setting Range	Initial Value
● 1	Maximum setting	0 to 12000r/min/ 0 to 8000r/min ^{*1}	3000r/min
● 2	Minimum setting	0 to 3600r/min/ 0 to 2400r/min ^{*1}	0r/min
● 4	Multi-speed setting (high speed)	0 to 12000r/min/ 0 to 8000r/min ^{*1}	3000r/min
● 5	Multi-speed setting (middle speed)	0 to 12000r/min/ 0 to 8000r/min ^{*1}	1500r/min
● 6	Multi-speed setting (low speed)	0 to 12000r/min/ 0 to 8000r/min ^{*1}	300r/min
● 7	Acceleration time	0 to 3600s	5s
● 8	Deceleration time	0 to 3600s	5s
● 9	Electronic thermal O/L relay	0 to 500A	Rated motor current
10	Coasting speed	0 to 3600r/min/ 0 to 2400r/min ^{*1}	90r/min
11	DC injection brake operation time	0 to 10s	0.5s
13	Starting speed	0 to 1800r/min/ 0 to 1200r/min ^{*1}	15r/min
15	Jog speed setting	0 to 12000r/min/ 0 to 8000r/min ^{*1}	150r/min
16	Jog acceleration/deceleration time	0 to 3600s	0.5s
17	MRS input selection	0, 2, 4	0
20	Acceleration/deceleration reference speed	30 to 12000r/min/ 20 to 8000r/min ^{*1}	3000r/min
22	Stall prevention operation level	0 to 200%	150%
24	Multi-speed setting (speed 4)	0 to 12000r/min/ 0 to 8000r/min ^{*1} , 9999	9999
25	Multi-speed setting (speed 5)	0 to 12000r/min/ 0 to 8000r/min ^{*1} , 9999	9999
26	Multi-speed setting (speed 6)	0 to 12000r/min/ 0 to 8000r/min ^{*1} , 9999	9999
27	Multi-speed setting (speed 7)	0 to 12000r/min/ 0 to 8000r/min ^{*1} , 9999	9999
29	Acceleration/deceleration pattern selection	0, 1, 2	0
30	Regenerative function selection	0, 1	0
31	Speed jump 1A	0 to 12000r/min/ 0 to 8000r/min ^{*1} , 9999	9999
32	Speed jump 1B	0 to 12000r/min/ 0 to 8000r/min ^{*1} , 9999	9999
33	Speed jump 2A	0 to 12000r/min/ 0 to 8000r/min ^{*1} , 9999	9999
34	Speed jump 2B	0 to 12000r/min/ 0 to 8000r/min ^{*1} , 9999	9999
35	Speed jump 3A	0 to 12000r/min/ 0 to 8000r/min ^{*1} , 9999	9999
36	Speed jump 3B	0 to 12000r/min/ 0 to 8000r/min ^{*1} , 9999	9999

Parameter	Name	Setting Range	Initial Value
37	Speed display	0, 0.01 to 9998	0
40	RUN key rotation direction selection	0, 1	0
41	Up-to-speed sensitivity	0 to 100%	10%
42	Speed detection	0 to 12000r/min/ 0 to 8000r/min ^{*1}	180r/min
43	Speed detection for reverse rotation	0 to 12000r/min/ 0 to 8000r/min ^{*1} , 9999	9999
44	Second acceleration/ deceleration time	0 to 3600s	5s
45	Second deceleration time	0 to 3600s, 9999	9999
48	Second stall prevention operation current	0 to 200%, 9999	9999
52	DU/PU main display data selection	0, 5, 8 to 12, 14, 20, 23 to 25, 52 to 55, 61, 62, 64, 100	0
54	FM terminal function selection	1 to 3, 5, 8 to 12, 14, 21, 24, 52, 53, 61, 62	1
55	Speed monitoring reference	0 to 12000r/min/ 0 to 8000r/min ^{*1}	3000r/min
56	Current monitoring reference	0 to 500A	Rated motor current
59	Remote function selection	0, 1, 2, 3	0
65	Retry selection	0 to 5	0
67	Number of retries at fault occurrence	0 to 10, 101 to 110	0
68	Retry waiting time	0.1 to 600s	1s
69	Retry count display erase	0	0
70	Special regenerative brake duty	0 to 30%	0%
73	Analog input selection	0, 1, 10, 11	1
74	Input filter time constant	0 to 8	1
75	Reset selection/disconnected PU detection/PU stop selection	0 to 3, 14 to 17	14
77	Parameter write selection	0, 1, 2	0
78	Reverse rotation prevention selection	0, 1, 2	0
● 79	Operation mode selection	0, 1, 2, 3, 4, 6, 7	0
117	PU communication station number	0 to 31 (0 to 247)	0
118	PU communication speed	48, 96, 192, 384	192
119	PU communication stop bit length	0, 1, 10, 11	1
120	PU communication parity check	0, 1, 2	2
121	Number of PU communication retries	0 to 10, 9999	1
122	PU communication check time interval	0, 0.1 to 999.8s, 9999	0
123	PU communication waiting time setting	0 to 150ms, 9999	9999

Parameter	Name	Setting Range	Initial Value
124	PU communication CR/LF selection	0, 1, 2	1
⊙ 125	Terminal 2 speed setting gain speed	0 to 12000r/min/ 0 to 8000r/min *	3000r/min
⊙ 126	Terminal 4 speed setting gain speed	0 to 12000r/min/ 0 to 8000r/min *	3000r/min
127	PID control automatic switchover speed	0 to 12000r/min/ 0 to 8000r/min *, 9999	9999
128	PID action selection	0, 20, 21	0
129	PID proportional band	0.1 to 1000%, 9999	100%
130	PID integral time	0.1 to 3600s, 9999	1s
131	PID upper limit	0 to 100%, 9999	9999
132	PID lower limit	0 to 100%, 9999	9999
133	PID action set point	0 to 100%, 9999	9999
134	PID differential time	0.01 to 10s, 9999	9999
144	Speed setting switchover	2, 4, 6, 8, 10, 102, 104, 106, 108, 110	104/106 *
145	PU display language selection	0 to 7	0
150	Output current detection level	0 to 200%	150%
151	Output current detection signal delay time	0 to 10s	0s
152	Zero current detection level	0 to 200%	5%
153	Zero current detection time	0 to 1s	0.5s
156	Stall prevention operation selection	0 to 31, 100, 101	0
157	OL signal output timer	0 to 25s, 9999	0s
⊙ 160	Extended function display selection	0, 9999	9999
161	Speed setting/key lock operation selection	0, 1, 10, 11	0
166	Output current detection signal retention time	0 to 10s, 9999	0.1s
167	Output current detection operation selection	0, 1	0
168	Parameter for manufacturer setting. Do not set.		
169			
170	Watt-hour meter clear	0, 10, 9999	9999
171	Operation hour meter clear	0, 9999	9999
178	STF terminal function selection		60
179	STR terminal function selection	0 to 5, 7, 8, 10, 12, 14, 16, 23 to 25, 60(Pr:178), 61(Pr:179),	61
180	RL terminal function selection	62, 64 to 67, 72, 9999	0
181	RM terminal function selection		1
182	RH terminal function selection		2

Parameter	Name	Setting Range	Initial Value
190	RUN terminal function selection	0, 1, 3, 4, 7, 8, 11 to 16, 21, 25, 26, 33, 47, 48, 64, 70, 79, 90, 91, 93(Pr:190), 95, 96, 98 to 101, 103, 104, 107, 108, 111 to 116, 121, 125, 126, 133, 147, 148, 164, 170, 179, 190, 191, 193(Pr:190), 195, 196, 198, 199, 99999	0
192	A,B,C terminal function selection		99
232	Multi-speed setting (speed 8)	0 to 12000r/min/ 0 to 8000r/min *, 9999	9999
233	Multi-speed setting (speed 9)	0 to 12000r/min/ 0 to 8000r/min *, 9999	9999
234	Multi-speed setting (speed 10)	0 to 12000r/min/ 0 to 8000r/min *, 9999	9999
235	Multi-speed setting (speed 11)	0 to 12000r/min/ 0 to 8000r/min *, 9999	9999
236	Multi-speed setting (speed 12)	0 to 12000r/min/ 0 to 8000r/min *, 9999	9999
237	Multi-speed setting (speed 13)	0 to 12000r/min/ 0 to 8000r/min *, 9999	9999
238	Multi-speed setting (speed 14)	0 to 12000r/min/ 0 to 8000r/min *, 9999	9999
239	Multi-speed setting (speed 15)	0 to 12000r/min/ 0 to 8000r/min *, 9999	9999
241	Analog input display unit switchover	0, 1	0
244	Cooling fan operation selection	0, 1	1
249	Earth (ground) fault detection at start	0, 1	0
250	Stop selection	0 to 100s, 1000 to 1100s, 8888, 9999	9999
251	Output phase loss protection selection	0, 1	1
255	Life alarm status display	(0 to 15)	0
256	Inrush current limit circuit life display	(0 to 100%)	100%
257	Control circuit capacitor life display	(0 to 100%)	100%
258	Main circuit capacitor life display	(0 to 100%)	100%
259	Main circuit capacitor life measuring	0, 1 (2, 3, 8, 9)	0
267	Terminal 4 input selection	0, 1, 2	0
268	Monitor decimal digits selection	0, 1, 9999	9999
269	Parameter for manufacturer setting. Do not set.		
295	Magnitude of speed change setting	0, 0.01, 0.10, 1.00, 10.00	0
296	Password lock level	1 to 6, 101 to 106, 9999	9999

Parameter	Name	Setting Range	Initial Value
297	Password lock/unlock	1000 to 9998 (0 to 5, 9999)	9999
338	Communication operation command source	0, 1	0
339	Communication speed command source	0, 1, 2	0
340	Communication startup mode selection	0, 1, 10	0
342	Communication EEPROM write selection	0, 1	0
343	Communication error count	—	0
374	Overspeed detection level	0 to 12000r/min/ 0 to 8000r/min *1	3450r/min
495	Remote output selection	0, 1, 10, 11	0
496	Remote output data 1	0 to 4095	0
502	Stop mode selection at communication error	0, 1, 2, 3	0
503	Maintenance timer	0 (1 to 9998)	0
504	Maintenance timer alarm output set time	0 to 9998, 9999	9999
505	Speed setting reference	1 to 200Hz	100Hz/ 150Hz *1
549	Protocol selection	0, 1	0
551	PU mode operation command source selection	2, 4, 9999	9999
553	PID deviation limit	0 to 100%, 9999	9999
554	PID signal operation selection	0 to 3, 10 to 13	0
555	Current average time	0.1 to 1s	1s
556	Data output mask time	0 to 20s	0s
557	Current average value monitor signal output reference current	0 to 500A	Rated motor current
561	PTC thermistor protection level	0.5 to 30kΩ, 9999	9999
563	Energization time carrying-over times	(0 to 65535)	0
564	Operating time carrying-over times	(0 to 65535)	0
575	Output interruption detection time	0 to 3600s, 9999	1s
576	Output interruption detection level	0 to 12000r/min/ 0 to 8000r/min *1	0r/min
577	Output interruption cancel level	900 to 1100%	1000%
665	Regeneration avoidance speed gain	0 to 200%	100
736	Electromagnetic brake interlock time	0 to 1s	0.00s
779	Operation speed during communication error	0 to 12000r/min/ 0 to 8000r/min *1, 9999	9999
785	PM control torque boost	0 to 150%, 9999	9999
791	Acceleration time in low-speed range	0 to 3600s, 9999	9999
792	Deceleration time in low-speed range	0 to 3600s, 9999	9999
795	DC brake torque boost	0 to 150%, 9999	9999
799	Pulse increment setting for output power	0.1kWh, 1kWh, 10kWh, 100kWh, 1000kWh	1kWh
800	Control method selection	9, 30	30
820	Speed control P gain	0 to 1000%	15%
821	Speed control integral time	0 to 20s	0.333s
870	Speed detection hysteresis	0 to 150r/min/ 0 to 100r/min *1	15r/min
872	Input phase loss protection selection	0, 1	0

Parameter	Name	Setting Range	Initial Value
882	Regeneration avoidance operation selection	0, 1, 2	0
883	Regeneration avoidance operation level	300 to 800V	400VDC
885	Regeneration avoidance compensation speed limit value	0 to 900r/min/0 to 600r/min *1, 9999	180r/min
886	Regeneration avoidance voltage gain	0 to 200%	100%
888	Free parameter 1	0 to 9999	9999
889	Free parameter 2	0 to 9999	9999
891	Cumulative power monitor digit shifted times	0 to 4, 9999	9999
C0 (900) *2	FM terminal calibration	—	—
C2 (902) *2	Terminal 2 speed setting bias speed	0 to 12000r/min/ 0 to 8000r/min *1	0r/min
C3 (902) *2	Terminal 2 speed setting bias	0 to 300%	0%
125 (903) *2	Terminal 2 speed setting gain speed	0 to 12000r/min/ 0 to 8000r/min *1	3000r/min
C4 (903) *2	Terminal 2 speed setting gain	0 to 300%	100%
C5 (904) *2	Terminal 4 speed setting bias speed	0 to 12000r/min/ 0 to 8000r/min *1	0r/min
C6 (904) *2	Terminal 4 speed setting bias	0 to 300%	20%
126 (905) *2	Terminal 4 speed setting gain speed	0 to 12000r/min/ 0 to 8000r/min *1	3000r/min
C7 (905) *2	Terminal 4 speed setting gain	0 to 300%	100%
C42 (934) *2	PID display bias coefficient	0 to 500, 9999	9999
C43 (934) *2	PID display bias analog value	0 to 300%	20%
C44 (935) *2	PID display gain coefficient	0 to 500, 9999	9999
C45 (935) *2	PID display gain analog value	0 to 300%	100%
990	PU buzzer control	0, 1	1
991	PU contrast adjustment	0 to 63	58
997	Fault initiation	16 to 18, 32 to 34, 48, 49, 64, 82, 96, 97, 112, 128, 129, 144, 145, 176 to 178, 192, 196, 197, 199, 201, 208, 230, 245, 9999	9999
© 999	Automatic parameter setting	10, 9999	9999
Pr.CL	Parameter clear	0, 1	0
ALLC	All parameter clear	0, 1	0
Er.CL	Faults history clear	0, 1	0
Pr.CH	Initial value change list	—	—
AUTO	Automatic parameter setting	—	—

*1 Differ according to capacities. (0.2K to 2.2K/3.7K)

*2 The parameter number in parentheses is the one for use with the parameter unit (FR-PU07).



REMARKS

- The unit for parameter setting and its setting range can be changed from "r/min" to "Hz". Use Pr.144 to change the setting.
- With operation panel, the value up to 9999 can be set. With parameter unit (FR-PU07), up to the highest value in the setting range can be set.
- A value exceeding 3000r/min can be also set, but the actual operation will be limited at 3000r/min, which is the upper speed limit of the motor.

7 TROUBLESHOOTING

When a fault occurs in the drive unit, the drive unit trips and the PU display automatically changes to one of the following fault or alarm indications.

If the fault does not correspond to any of the following faults or if you have any other problem, please contact your sales representative.

- Retention of fault output signal.. When the magnetic contactor (MC) provided on the input side of the drive unit is opened at a fault occurrence, the drive unit's control power will be lost and the fault output will not be held.
- Fault or alarm indication.....When a fault or alarm occurs, the operation panel display automatically switches to the fault or alarm indication.
- Resetting method.....When a fault occurs, the drive unit output is kept stopped. Unless reset, therefore, the drive unit cannot restart. (Refer to page 31)
- When any fault occurs, take the appropriate corrective action, then reset the drive unit, and resume operation.
Not doing so may lead to the drive unit fault and damage.

drive unit fault or alarm indications are roughly categorized as below.

- (1) Error message
A message regarding operational fault and setting fault by the operation panel and parameter unit (FR-PU07) is displayed. The drive unit does not trip.
- (2) Warning
The drive unit does not trip even when a warning is displayed. However, failure to take appropriate measures will lead to a fault.
- (3) Alarm
The drive unit does not trip. You can also output an alarm signal by making parameter setting.
- (4) Fault
When a fault occurs, the drive unit trips and a fault signal is output.

REMARKS

- For the details of fault displays and other malfunctions, also refer to the Instruction Manual (Applied).
- Past eight faults can be displayed using the setting dial. (Refer to page 3 for the operation.)

7.1 Reset method of protective function

(1) Resetting the drive unit

The drive unit can be reset by performing any of the following operations. Note that the internal thermal integrated value of the electronic thermal relay function and the number of retries are cleared (erased) by resetting the drive unit. Drive unit recovers about 1s after the reset is released.

Operation 1: Using the operation panel, press  to reset the drive unit.

(This may only be performed when a fault occurs (Refer to page 32 for fault.)

Operation 2: Switch power OFF once. After the indicator of the operation panel turns OFF, switch it ON again.

Operation 3: Turn ON the reset signal (RES) for more than 0.1s. (If the RES signal is kept ON, "Err." appears (flickers) to indicate that the drive unit is in a reset status.)

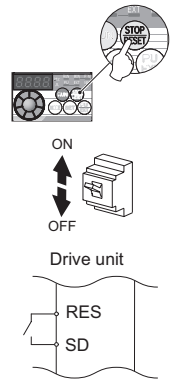

NOTE

- OFF status of the start signal must be confirmed before resetting the drive unit fault. Resetting drive unit fault with the start signal ON restarts the motor suddenly.

7.2 List of fault displays



When a fault occurs, the drive unit trips and the PU display automatically changes to one of the following fault or alarm indications.

The error message shows an operational error. The drive unit output is not shut off.

Warnings are messages given before faults occur. The drive unit output is not shut off.

Alarms warn the operator of failures with output signals. The drive unit output is not shut off.

When faults occur, the protective functions are activated to drive unit trip and output the fault signals.

Function Name	Description	Countermeasure	Display	
Error message	Operation panel lock	Operation has been attempted during the operation panel lock.	Press  for 2s to release lock.	HOL d
	Password locked	Reading/writing of a password-restricted parameter has been attempted.	Enter the password in Pr. 297 Password lock/unlock to unlock the password function before operating.	LOC d
	Write disable error	<ul style="list-style-type: none"> Parameter setting has been attempted although parameter writing is set to be disabled. Overlapping range has been set for the speed jump. PU and the drive unit cannot make normal communication. 	<ul style="list-style-type: none"> Check the setting of Pr. 77 Parameter write selection. Check the setting of Pr. 31 to Pr. 36 (speed jump). Check the connection of PU and the drive unit. 	Er 1
	Write error during operation	Parameter writing has been attempted while a value other than "2" is set in Pr. 77 Parameter write selection and the STF (STR) is ON.	<ul style="list-style-type: none"> Set "2" in Pr. 77 Parameter write selection. After stopping the operation, set parameters. 	Er 2
	Calibration error	Analog input bias and gain calibration values have been set too close.	Check the settings of calibration parameters C3, C4, C6 and C7 (calibration functions).	Er 3
	Mode designation error	<ul style="list-style-type: none"> Parameter setting has been attempted in the External or NET operation mode when Pr. 77 Parameter write selection is not "2." Parameter writing has been attempted when the command source is not at the operation panel. 	<ul style="list-style-type: none"> After setting the operation mode to the "PU operation mode", set parameters. Set "2" in Pr. 77 Parameter write selection. Remove the parameter unit (FR-PU07), then set the Pr. 551 PU mode operation command source selection = "9999 (initial setting)." Set Pr. 551 PU mode operation command source selection = "4." 	Er 4
	Drive unit reset	The reset signal (RES signal) is ON. (drive unit output is shutoff.)	<ul style="list-style-type: none"> Turn OFF the reset command. 	Err.
Warning	Stall prevention (overcurrent)	The overcurrent stall prevention has been activated.	<ul style="list-style-type: none"> Set Pr.7 Acceleration time and Pr.8 Deceleration time longer. Reduce the load Set the stall prevention operation current in Pr. 22 Stall prevention operation level. (The acceleration/deceleration time may change.) Increase the stall prevention operation level with Pr. 22 Stall prevention operation level, or disable stall prevention with Pr. 156 Stall prevention operation selection. (Operation at OL occurrence can be selected using Pr. 156 Stall prevention operation selection.) Check the connection of the PM motor. 	OL
	Stall prevention (overvoltage)	The overvoltage stall prevention function or the regeneration avoidance function has been activated. (This warning is also output during the regeneration avoidance operation.)	Set the deceleration time longer.	oL
	Regenerative brake pre-alarm *2	The regenerative brake duty has reached 85% of the Pr. 70 Special regenerative brake duty setting or higher.	<ul style="list-style-type: none"> Set the deceleration time longer. Check the Pr.30 Regenerative function selection and Pr. 70 Special regenerative brake duty settings. 	r b
	Electronic thermal relay function pre-alarm *1	The cumulative value of the electronic thermal O/L relay has reached 85% of the Pr. 9 Electronic thermal O/L relay setting or higher.	<ul style="list-style-type: none"> Reduce the load and frequency of operation. Set an appropriate value in Pr. 9 Electronic thermal O/L relay. 	r H
	PU stop	 on the operation panel has been pressed during the External operation.	Turn the start signal OFF and release with  .	P S
	Maintenance signal output *2	The cumulative energization time has exceeded the maintenance output timer set value.	Setting "0" in Pr. 503 Maintenance timer erases the signal.	M F
	Undervoltage	The voltage at the main circuit power has been lowered.	Investigate the devices on the power supply line such as the power supply itself.	U u
SA	The shorting wire across the terminals S1 and SC or the terminals S2 and SC is disconnected.	Short across the terminals S1 and SC and the terminals S2 and SC with shortening wires.	S R	
Alarm	Fan alarm	The cooling fan is at a standstill although it is required to be operated. Cooling fan speed has decelerated.	Check for fan failure. Please contact your sales representative.	F n

Function Name	Description	Countermeasure	Display	
Fault	Overcurrent trip during acceleration	Overcurrent has occurred during acceleration.	<ul style="list-style-type: none"> Set the acceleration time longer. (Shorten the downward acceleration time in vertical lift application.) If "E.OC1" always appears at start, disconnect the motor once and restart the drive unit. If "E.OC1" still appears, the drive unit may be faulty. Contact your sales representative. Check the wiring for output short circuit and ground fault. Change the setting to enable the stall prevention operation. (Pr.156) Lower the stall prevention operation level. Choose drive unit and motor capacities that match. If the motor is coasting, stop the motor, then input a start command. 	E.OC 1
	Overcurrent trip during constant speed	Overcurrent has occurred during constant speed operation.	<ul style="list-style-type: none"> Keep the load stable Check the wiring to avoid output short circuit or ground fault. Change the setting to enable the stall prevention operation. (Pr.156) Lower the stall prevention operation level. Choose drive unit and motor capacities that match. If the motor is coasting, stop the motor, then input a start command. 	E.OC 2
	Overcurrent trip during deceleration or stop	Overcurrent has occurred during deceleration or at a stop.	<ul style="list-style-type: none"> Set the deceleration time longer. Check the wiring to avoid output short circuit or ground fault. Check if the mechanical brake is set to be activated too early. Change the setting to enable the stall prevention operation. (Pr.156) Lower the stall prevention operation level. Choose drive unit and motor capacities that match. If the motor is coasting, stop the motor, then input a start command. 	E.OC 3
	Regenerative overvoltage trip during acceleration	Overvoltage has occurred during acceleration.	<ul style="list-style-type: none"> Set the acceleration time shorter. Use the regeneration avoidance function (Pr. 882, Pr. 883, Pr. 885, Pr. 886). Set the Pr. 22 Stall prevention operation level correctly. 	E.OV 1
	Regenerative overvoltage trip during constant speed	Overvoltage has occurred during constant speed operation.	<ul style="list-style-type: none"> Keep the load stable Use the regeneration avoidance function (Pr. 882, Pr. 883, Pr. 885, Pr. 886). Use the brake resistor, brake unit or power regeneration common converter (FR-CV) as required. Set the Pr. 22 Stall prevention operation level correctly. 	E.OV 2
	Regenerative overvoltage trip during deceleration or stop	Overvoltage has occurred during deceleration or at a stop.	<ul style="list-style-type: none"> Set the deceleration time longer. (Set the deceleration time which matches the moment of inertia of the load.) Make the brake cycle longer. Use the regeneration avoidance function (Pr. 882, Pr. 883, Pr. 885, Pr. 886). Use the brake resistor, brake unit or power regeneration common converter (FR-CV) as required. 	E.OV 3

Function Name	Description	Countermeasure	Display	
Fault	Drive unit overload trip (electronic thermal O/L relay function) *1	The electronic thermal relay function for drive unit element protection has been activated.	<ul style="list-style-type: none"> Set the acceleration time longer. Adjust the <i>Pr:785 PM control torque boost</i> and <i>Pr:795 DC brake torque boost</i> settings. Reduce the load. Set the surrounding air temperature to within the specifications. 	E _F H _F
	Motor overload trip (electronic thermal O/L relay function) *1	The electronic thermal relay function for motor protection has been activated.	<ul style="list-style-type: none"> Reduce the load. Adjust the <i>Pr:785 PM control torque boost</i> and <i>Pr:795 DC brake torque boost</i> settings. Set the stall prevention operation level accordingly. 	E _F H _M
	Heatsink overheat	The heatsink has overheated.	<ul style="list-style-type: none"> Set the surrounding air temperature to within the specifications. Clean the heatsink. Replace the cooling fan. 	E _F I _o
	Input phase loss *2	One of the three phases on the drive unit input side has been lost. It may also appear if phase-to-phase voltage of the three-phase power input has become largely unbalanced.	<ul style="list-style-type: none"> Wire the cables properly. Repair a break portion in the cable. Check the <i>Pr:872 Input phase loss protection selection</i> setting. Set <i>Pr:872 Input phase loss protection selection</i> = "0" (without input phase loss protection) when three-phase input voltage is largely unbalanced. 	E _I L _F
	Stall prevention stop	<ul style="list-style-type: none"> The rotation speed has dropped to 15r/min as a result of deceleration due to the excess motor load. Operation was performed without connecting a motor. 	<ul style="list-style-type: none"> Reduce the load. (Check the <i>Pr:22 Stall prevention operation level</i> setting.) Check the connection of the PM motor, or set the PM motor test operation. 	E _D L _F
	Loss of synchronism detection	Operation has gone out of synchronism.	<ul style="list-style-type: none"> Set the acceleration time longer. Reduce the load. If the motor is coasting, stop the motor, then input a start command. Alternatively, use the automatic restart after instantaneous power failure/flying start function. Drive the dedicated PM motor (S-PM series). 	E _S D _F
	Brake transistor alarm detection	A fault has occurred in the brake circuit, such as a brake transistor breakage. (In this case, the drive unit must be powered off immediately.)	Replace the drive unit.	E _b E
	Output side earth (ground) fault overcurrent at start *2	An earth (ground) fault has occurred on the drive unit's output side (detected only at a start).	Remedy the ground fault portion.	E _o G _F
	Output phase loss	One of the three phases (U, V, W) on the drive unit's output side (load side) has been lost during drive unit operation.	<ul style="list-style-type: none"> Wire the cables properly. If the motor is coasting, stop the motor, then input a start command. 	E _o L _F
	External thermal relay operation *2	The external thermal relay connected to the OH signal has been activated.	<ul style="list-style-type: none"> Reduce the load and operate less frequently. Even if the relay contacts are reset automatically, the drive unit will not restart unless it is reset. 	E _D H _F
	PTC thermistor operation *2	Resistance of the PTC thermistor connected between the terminal 2 and terminal 10 has reached the <i>Pr:361 PTC thermistor protection level</i> setting or higher.	Reduce the load.	E _P T _C
Parameter storage device fault	Operation of the component where parameters are stored (control circuit board) has become abnormal.	Please contact your sales representative. When performing parameter writing frequently for communication purposes, set "1" in <i>Pr:342 Communication EEPROM write selection</i> to enable RAM write. Note that powering OFF returns the drive unit to the status before RAM write.	E _o P _E	

Function Name	Description	Countermeasure	Display	
Fault	PU disconnection	<ul style="list-style-type: none"> A communication error has occurred between the PU and the drive unit. The communication interval has exceeded the permissible time period during RS-485 communication via the PU connector. The number of communication errors has exceeded the number of retries. 	<ul style="list-style-type: none"> Connect the parameter unit cable securely. Check the communication data and communication settings. Increase the Pr. 122 PU communication check time interval setting. Or set "9999" (no communication check). 	ErPE
	Retry count excess *2	Operation restart within the set number of retries has failed.	Eliminate the cause of the error preceding this error indication.	ErEF
	CPU fault	An error has occurred in the CPU and in the peripheral circuits.	<ul style="list-style-type: none"> Take measures against noises if there are devices producing excess electrical noises around the drive unit. If the situation does not improve after taking the above measure, please contact your sales representative. 	ErS1 ErPU
	Output current detection value exceeded *2	Output current has exceeded the output current detection level that is set in the parameter.	Check the settings of Pr. 150 Output current detection level, Pr. 151 Output current detection signal delay time, Pr. 166 Output current detection signal retention time, and Pr. 167 Output current detection operation selection.	ErOD
	Inrush current limit circuit fault	The resistor of the inrush current limit circuit has overheated.	Configure a circuit where frequent power ON/OFF is not repeated. If the situation does not improve after taking the above measure, please contact your sales representative.	ErOH
	Analog input fault	A voltage(current) has been input to terminal 4 when the setting in Pr. 267 Terminal 4 input selection and the setting of voltage/current input switch are different.	Give a speed command by a current input or set Pr. 267 Terminal 4 input selection, and set the voltage/current input switch to voltage input.	ErA1E
	Overspeed occurrence	The motor speed has exceeded the Pr. 374 Overspeed detection level.	Check that the Pr. 374 Overspeed detection level value is correct.	ErOS
	PID signal fault	PID upper limit (FUP), PID lower limit (FDN), or PID deviation limit (Y48) has turned ON.	Make correct settings for Pr.131 PID upper limit, Pr.132 PID lower limit, Pr.553 PID deviation limit.	ErPd
E.SAF	<ul style="list-style-type: none"> An internal circuit fault has occurred. Either the contact between terminals S1 and SC or terminals S2 and SC has opened. 	Short across the terminals S1 and SC and the terminals S2 and SC with shortening wires.	ErSAF	

*1 Resetting the drive unit initializes the internal cumulative heat value of the electronic thermal relay function.

*2 This protective function is not available in the initial status.

7.3 Check first when you have a trouble

Description	Countermeasure
Motor does not start.	Check start and speed command sources and enter a start command (STF, etc.) and a speed command.
Motor or machine is making abnormal acoustic noise.	Take EMC measures if a steady operation cannot be performed due to EMI. Alternatively, set the Pr.74 Input filter time constant setting higher.
Drive unit generates abnormal noise.	Install the fan cover correctly.
Motor generates heat abnormally.	Clean the motor fan. Improve the environment.
Motor rotates in the opposite direction.	Connect phase sequence of the output cables (terminal U, V, W) to the motor correctly. Check the rotation direction specification of the motor's output shaft. Alternatively, check the connection of the start signal. (STF: forward rotation, STR: reverse rotation)
Speed greatly differs from the setting.	Check the settings of Pr.1 Maximum setting, Pr.2 Minimum setting, and calibration parameters C2 to C7.
Acceleration/deceleration is not smooth.	Reduce the load. Alternatively, increase the acceleration/deceleration time. Make adjustments to situate the machine equipment in a more stable place. Eliminate the load fluctuation. Use Pr.156 Stall prevention operation selection to disable stall prevention operation.
Speed varies during operation.	Check the speed setting signals.
Operation mode is not changed properly.	Turn OFF the start signal (STF or STR). Check if Pr.79 Operation mode selection is set appropriately.
Operation panel display is not operating.	Check the wiring and the installation.
Speed does not accelerate.	Check the settings of Pr.1 Maximum setting, Pr.2 Minimum setting, and calibration parameters C2 to C7.
Unable to write parameter setting.	Check Pr.77 Parameter write selection.

* For further information on troubleshooting, refer to the  Instruction Manual (Applied).

8 PRECAUTIONS FOR MAINTENANCE AND INSPECTION

The drive unit is a static unit mainly consisting of semiconductor devices. Daily inspection must be performed to prevent any fault from occurring due to the adverse effects of the operating environment, such as temperature, humidity, dust, dirt and vibration, changes in the parts with time, service life, and other factors.



REMARKS

- For maintenance/inspection and parts life, also refer to the Instruction Manual (Applied).

●Precautions for maintenance and inspection

For some short time after the power is switched OFF, a high voltage remains in the smoothing capacitor. When accessing the drive unit for inspection, wait for at least 10 minutes after the power supply has been switched OFF, and then make sure that the voltage across the main circuit terminals P/+ and N/- of the drive unit is not more than 30VDC using a tester, etc.

8.1 Inspection items

Area of Inspection	Inspection Item	Description	Interval		Corrective Action at Alarm Occurrence	Customer's Check		
			Daily	Periodic*2				
General	Surrounding environment	Check the surrounding air temperature, humidity, dirt, corrosive gas, oil mist, etc.	○		Improve environment			
	Overall unit	Check for unusual vibration and noise.	○		Check alarm location and retighten			
		Check for dirt, oil, and other foreign material.	○		Clean			
Power supply voltage	Check that the main circuit voltages are normal.*1		○		Inspect the power supply			
Main circuit	General	(1) Check with megger (across main circuit terminals and earth (ground) terminal).		○	Contact the manufacturer			
		(2) Check for loose screws and bolts.		○	Retighten			
		(3) Check for overheat traces on the parts.		○	Contact the manufacturer			
		(4) Check for stain		○	Clean			
	Conductors, cables	(1) Check conductors for distortion.			○	Contact the manufacturer		
		(2) Check cable sheaths for breakage and deterioration (crack, discoloration, etc.)			○	Contact the manufacturer		
Terminal block	Check for damage.			○	Stop the device and contact the manufacturer.			
Smoothing aluminum electrolytic capacitor	(1) Check for liquid leakage.			○	Contact the manufacturer			
	(2) Check for safety valve projection and bulge.			○	Contact the manufacturer			
Relay	(3) Visual check and judge by the life check of the main circuit capacitor (Refer to Chapter 4 of the Instruction Manual (Applied).)			○	Contact the manufacturer			
	Check that the operation is normal and no chatter is heard.			○	Contact the manufacturer			
Control circuit, Protective circuit	Operation check	(1) Check that the output voltages across phases with the drive unit operated alone is balanced			○	Contact the manufacturer		
		(2) Check that no fault is found in protective and display circuits in a sequence protective operation test.			○	Contact the manufacturer		
	P-arts check	Overall	(1) Check for unusual odor and discoloration.			○	Stop the device and contact the manufacturer.	
		Aluminum electrolytic capacitor	(2) Check for serious rust development			○	Contact the manufacturer	
Cooling system	Cooling fan	(1) Check for liquid leakage in a capacitor and deformation trace			○	Contact the manufacturer		
		(2) Visual check and judge by the life check of the main circuit capacitor (Refer to Chapter 4 of the Instruction Manual (Applied).)			○	Contact the manufacturer		
Cooling system	Heatsink	(1) Check for unusual vibration and noise.		○	Replace the fan			
		(2) Check for loose screws and bolts		○	Fix with the fan cover fixing screws			
Display	Indication	(3) Check for stain		○	Clean			
		(1) Check for clogging		○	Clean			
Display	Meter	(2) Check for stain		○	Clean			
		Check that reading is normal		○	Stop the device and contact the manufacturer.			
Load motor	Operation check	Check for vibration and abnormal increase in operation noise		○	Stop the device and contact the manufacturer.			

*1 It is recommended to install a device to monitor voltage for checking the power supply voltage to the drive unit.

*2 One to two years of periodic inspection cycle is recommended. However, it differs according to the installation environment. Consult us for periodic inspection.

8.2 Replacement of parts

The drive unit consists of many electronic parts such as semiconductor devices.

The following parts may deteriorate with age because of their structures or physical characteristics, leading to reduced performance or fault of the drive unit. For preventive maintenance, the parts must be replaced periodically.

Use the life check function as a guidance of parts replacement.

Part Name	Estimated Lifespan *1	Description
Cooling fan	10 years	Replace (as required)
Main circuit smoothing capacitor	10 years *2	Replace (as required)
On-board smoothing capacitor	10 years *2	Replace the board (as required)
Relays	—	as required

*1 Estimated Lifespan for when the yearly average surrounding air temperature is 40°C (without corrosive gas, flammable gas, oil mist, dust and dirt etc.)

*2 Output current: 80% of the drive unit rated current



NOTE

For parts replacement, contact the nearest Mitsubishi FA Center.

9 SPECIFICATIONS

9.1 Rating

● Three-phase 200V power supply

Model FR-D720-□K-G		0.2	0.4	0.75	1.5	2.2	3.7
Applicable motor capacity (kW) ^{*1}		0.1	0.2	0.4	0.75	1.5	2.2
Output	Rated capacity (kVA) ^{*2}	0.3	0.6	1.0	1.7	2.8	4.0
	Rated current (A)	1.4	2.5	4.2	7.0	10.0	16.5
Overload current rating		150% 60s, 200% 0.5s (Rated motor current, inverse-time characteristics)					
Power supply	Rated input AC voltage/frequency	Three-phase 200 to 240V 50Hz/60Hz					
	Permissible AC voltage fluctuation	170 to 264V 50Hz/60Hz					
	Permissible frequency fluctuation	±5%					
	Power supply capacity (kVA) ^{*3}	0.4	0.7	1.2	2.1	4.0	5.5
Protective structure (JEM1030)		Enclosed type (IP20)					
Cooling system		Self-cooling			Forced air cooling		
Approximate mass (kg)		0.5	0.8	1.0	1.4	1.4	1.8

*1 Only the S-PM series motors are compatible. Use an S-PM motor with the capacity one rank lower than the drive unit capacity.

*2 The rated output capacity assumes 230V.

*3 The power supply capacity varies with the value of the power supply side drive unit impedance (including those of the input reactor and cables).

9.2 Common specifications

Control specifications	Control method		PM sensorless vector control (low-speed range: current synchronization operation)
	Carrier frequencies		5kHz
	Maximum speed		3000r/min (100Hz for 0.1kW to 1.5kW motor capacities, 150Hz for 2.2kW)
	Speed setting resolution	Analog input	3r/min/3000r/min (terminal2, 4: 0 to 10V/10 bits) 6r/min/3000r/min (terminal2, 4: 0 to 5V/9 bits) 3r/min/3000r/min (terminal4: 0 to 20mA/10 bits)
		Digital input	1r/min
	Frequency accuracy	Analog input	Within ±1% of the maximum output frequency (25°C ±10°C)
		Digital input	Within 0.01% of the set output frequency
	PM sensorless vector control range		1:10 (300r/min to 3000r/min)
	Starting torque		100% (initial value)
	Torque boost		PM control torque boost, DC injection brake torque boost
	Acceleration/deceleration time setting		0.1 to 3600s (acceleration and deceleration can be set individually), Linear and S-pattern acceleration/deceleration modes are available.
	Initial magnetic pole detection time		Approx. 0.1s (performed at start, at LX signal ON.)
Stall prevention operation level		Operation current level (0 to 200%), and whether to use the function or not can be selected	
Environment	Surrounding air temperature		-10°C to +50°C maximum (non-freezing) *1
	Ambient humidity		90%RH or less (non-condensing)
	Storage temperature*2		-20°C to +65°C
	Atmosphere		Indoors (without corrosive gas, flammable gas, oil mist, dust and dirt etc.)
	Altitude/vibration		Maximum 1000m above sea level, 5.9m/s ² or less at 10 to 55Hz (directions of X, Y, Z axes)

*1 When using the drive units at the surrounding air temperature of 40°C or less, the drive units can be installed closely attached (0cm clearance).

*2 Temperatures applicable for a short time, e.g. in transit.

9.3 Specifications of the dedicated PM motor [S-PM series]

9.3.1 Motor specifications

● Model names of S-PM geared motors

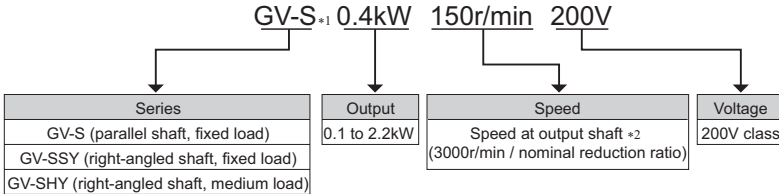

*1 For the model names of the flange types and brake-equipped types, refer to the catalog.

*2 For the detail of the output-shaft rotation speed (reduction ratio), refer to the catalog.

Motor model	GV-□□kW	0.1	0.2	0.4	0.75	1.5	2.2
Compatible drive unit	FR-D720-□K-G	0.2	0.4	0.75	1.5	2.2	3.7
Continuous characteristic *1	Rated output (kW)	0.1	0.2	0.4	0.75	1.5	2.2
	Rated torque (N·m) *2	0.32	0.64	1.27	2.39	4.78	7.00
Rated speed (r/min) *3		3000					
Maximum speed (r/min) *3		3000					
Number of poles		4					6
Maximum torque		150% 60s					
Rated current (A)		0.55	1.05	1.6	2.8	5.5	9.4
Structure		Totally enclosed self-cooling				Totally-enclosed fan-cooled	
Protective structure		IP44 (indoors), IP44 (outdoors) for semi-standard models					
Environment	Surrounding air temperature and humidity	0°C to +40°C (non-freezing), 90RH or less (non-condensing)					
	Vibration	4.9m/s ² (0.5G) for continuous operation, 9.8m/s ² (1G) for instantaneous operation					

*1 The above characteristics apply when the rated AC voltage is input from the drive unit (Refer to page 38). Output and rated motor speed are not guaranteed when the power supply voltage drops.

*2 The value at the motor shaft. The torque at the output shaft changes according to the reduction ratio and the reduction gear efficiency.

*3 The value at the motor shaft. The speed of the output shaft changes according to the reduction ratio.

9.3.2 Motor torque characteristic

<<Initial setting (Pr.785 = 9999 (=100%))>>

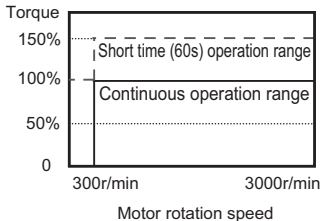

- The short-time torque can be up to 100% in low speed (300r/min) operation, but continuous operation is not available.
- When the input voltage is low, the torque may be reduced.
- The operable speed range at constant torque is 300r/min to 3000r/min. Continuous operation cannot be performed in 300r/min or less.

<<When Pr.785 = 50%>>

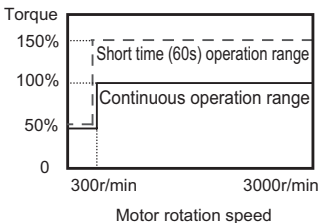

- Setting Pr.785 PM control torque boost = 50% or less* will enable continuous operation at 300r/min or lower. However, the keep the short-time torque to Pr.785 setting or lower.
* For FR-D720-1.5K-G or lower, it is 80% or lower.
- When the input voltage is low, the torque may be reduced.
- The operable speed range at constant torque is 300r/min to 3000r/min.

9.4 Outline dimension drawings

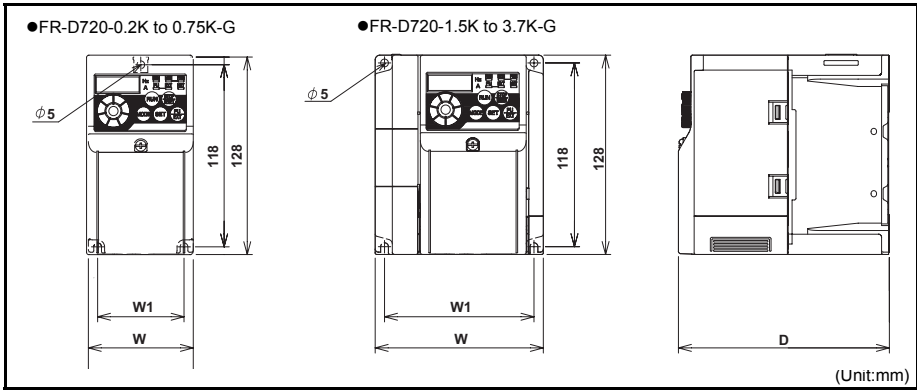

• Three-phase 200V class

Drive unit Model	W	W1	D
FR-D720-0.2K-G	68	56	80.5
FR-D720-0.4K-G			112.5
FR-D720-0.75K-G			132.5
FR-D720-1.5K-G	108	96	135.5
FR-D720-2.2K-G			142.5
FR-D720-3.7K-G			

Appendix 1 Instructions for Compliance with the EU Directives

The EU Directives are issued to standardize different national regulations of the EU Member States and to facilitate free movement of the equipment, whose safety is ensured, in the EU territory.

Since 1996, compliance with the EMC Directive that is one of the EU Directives has been legally required. Since 1997, compliance with the Low Voltage Directive, another EU Directive, has been also legally required. When a manufacturer confirms its equipment to be compliant with the EMC Directive and the Low Voltage Directive, the manufacturer must declare the conformity and affix the CE marking.

● The authorized representative in the EU

The authorized representative in the EU is shown below.

Name: Mitsubishi Electric Europe B.V.

Address: Gothaer Strasse 8, 40880 Ratingen, Germany

● Note

We declare that this drive unit, when equipped with the dedicated EMC filter, conforms with the EMC Directive in industrial environments and affix the CE marking on the drive unit.

When using the drive unit in a residential area, take appropriate measures and ensure the conformity of the drive unit used in the residential area.

(1) EMC Directive

We declare that this drive unit, when equipped with the EMC Directive compliant EMC filter, conforms with the EMC Directive and affix the CE marking on the drive unit (except the single-phase 100V power supply model).

- EMC Directive: 2004/108/EC
- Standard(s): EN61800-3:2004 (Second environment / PDS Category "C3")

Note: First environment

Environment including residential buildings. Includes building directly connected without a transformer to the low voltage power supply network which supplies power to residential buildings.

Second environment

Environment including all buildings except buildings directly connected without a transformer to the lower voltage power supply network which supplies power to residential buildings.

● Note

- * Set the EMC Directive compliant EMC filter to the drive unit. Insert line noise filters and ferrite cores to the power and control cables as required.
- * Connect the drive unit to an earthed power supply.
- * Install a motor, the EMC Directive compliant EMC filter, and a control cable according to the instructions written in the EMC Installation Guidelines (BCN-A21041-204). (Please contact your sales representative for the EMC Installation Guidelines.)
- * The cable length between the drive unit and the motor is 5m maximum.
- * Confirm that the final integrated system with the drive unit conforms with the EMC Directive.

(2) Low Voltage Directive

We have self-confirmed our drive units as products compliant to the Low Voltage Directive (Conforming standard EN 61800-5-1) and affix the CE marking on the drive units.

Outline of instructions

- * Do not use an earth leakage circuit breaker as an electric shock protector without connecting the equipment to the earth. Connect the equipment to the earth securely.
- * Wire the earth (ground) terminal independently. (Do not connect two or more cables to one terminal.)
- * Use the cable sizes on *page 14* under the following conditions.
 - Surrounding air temperature: 40°C maximum
 - If conditions are different from above, select appropriate wire according to EN60204 ANNEX C TABLE 5.
- * Use a tinned (plating should not include zinc) crimping terminal to connect the earth cable. When tightening the screw, be careful not to damage the threads.
- For use as a product compliant with the Low Voltage Directive, use PVC cable on *page 14*.
- * Use the moulded case circuit breaker and magnetic contactor which conform to the EN or IEC Standard.
- * When using an earth leakage circuit breaker, use a residual current operated protective device (RCD) of type B (breaker which can detect both AC and DC). If not, provide double or reinforced insulation between the drive unit and other equipment, or put a transformer between the main power supply and drive unit.
- * Use the drive unit under the conditions of overvoltage category II (usable regardless of the earth (ground) condition of the power supply), overvoltage category III (usable with the earthed-neutral system power supply, 400V class only) specified in IEC664.
 - To use the drive unit under the conditions of pollution degree 3, install it in the enclosure of IP54 or higher.
 - To use the drive unit outside of an enclosure in the environment of pollution degree 2, fix a fan cover with fan cover fixing screws enclosed.

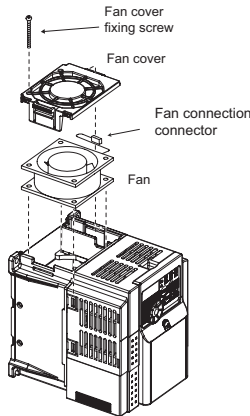

Example for FR-D720-2.2K-G

Note, the protection structure of the Drive unit units is considered to be an IP00.

- * On the input and output of the drive unit, use cables of the type and size set forth in EN60204 Appendix C.
- * The operating capacity of the relay outputs (terminal symbols A, B, C) should be 30VDC, 0.3A. (Relay output has basic isolation from the drive unit internal circuit.)
- * Control circuit terminals on *page 8* are safely isolated from the main circuit.
- * Environment

	Running	In Storage	During Transportation
Surrounding air temperature	-10°C to +50°C	-20°C to +65°C	-20°C to +65°C
Humidity	90% RH or less	90% RH or less	90% RH or less
Maximum Altitude	1000m	1000m	10000m

Details are given in the technical information "Low Voltage Directive Conformance Guide" (BCN-A21041-203). Please contact your sales representative for the manual.

* Select a UL and cUL certified fuse with Class T fuse equivalent cut-off speed or faster with the appropriate rating for branch circuit protection, or a UL489 molded case circuit breaker (MCCB) in accordance with the table below.

FR-D720-□□K-G		0.2	0.4	0.75	1.5	2.2	3.7
Rated fuse voltage(V)		240V or more					
Fuse maximum allowable rating (A)*	Without power factor improving reactor	15	15	20	30	40	60
	With power factor improving reactor	15	15	20	20	30	50
Molded case circuit breaker (MCCB) Maximum allowable rating (A)*		15	15	15	20	25	40

* Maximum allowable rating by US National Electrical Code. Exact size must be chosen for each installation.

* When using the electronic thermal relay function as motor overload protection, set the rated motor current in Pr. 9 *Electronic thermal O/L relay*.

Electronic thermal relay function operation characteristic

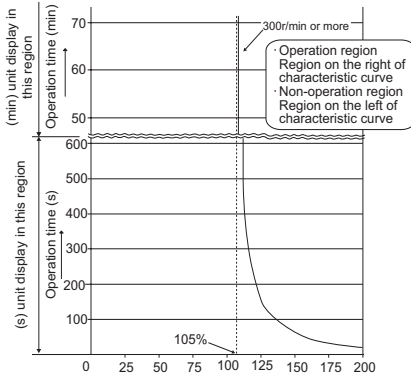

The ratio of motor current to Pr.9 *Electronic thermal O/L relay*

This function detects the overload (overheat) of the motor, stops the operation of the drive unit's output transistor, and stops the output.

(The operation characteristic is shown on the left)

- *1 When 50% of the drive unit rated output current (current value) is set in Pr. 9
- *2 The % value denotes the percentage to the drive unit rated output current. It is not the percentage to the motor rated current.

* Short circuit current ratings

Suitable For Use in A Circuit Capable of Delivering Not More Than 5 kA rms Symmetrical Amperes, 264V Maximum.

Appendix 2 Instructions for UL and cUL

(Standard to comply with: UL 508C, CSA C22.2 No. 14)

1. General precaution

The bus capacitor discharge time is 10 minutes. Before starting wiring or inspection, switch power off, wait for more than 10 minutes, and check for residual voltage between terminal P/+ and N/- with a meter etc., to avoid a hazard of electrical shock.

2. Installation

The below types of drive unit have been approved as products for use in enclosure and approval tests were conducted under the following conditions. Design the enclosure so that the surrounding air temperature, humidity and ambience of the drive unit will satisfy the specifications. (Refer to page 38)

Wiring protection

Integral solid state short circuit protection does not provide branch circuit protection. Branch circuit protection must be provided in accordance with the National Electrical Code for the U.S. or the Canadian Electrical Code for Canada and any additional codes. As specified, UL Class T fuses or any faster acting fuse with the appropriate rating or Listed UL 489 Molded Case Circuit Breaker (MCCB) must be employed. (Refer to page 43)

3. Short circuit ratings

Suitable For Use in A Circuit Capable of Delivering Not More Than 100 kA rms Symmetrical Amperes, 264 V Maximum.

4. Wiring

- The cables used should be 75°C copper cables.
- Tighten the terminal screws to the specified torques.
Undertightening can cause a short or misoperation.
Overtightening can cause the screws and unit to be damaged, resulting in a short or misoperation.
- Use the UL approved round crimping terminals. Crimp the terminals with the crimping tool recommended by the terminal manufacturer.

5. Motor overload protection

When using the electronic thermal relay function as motor overload protection, set the rated motor current to *Pr. 9 "Electronic thermal O/L relay"*. (Refer to page 43.)

Appendix 3 SERIAL number check

Check the SERIAL number indicated on the drive unit rating plate or package. (Refer to page 1)

Rating plate example

□	○	○	○○○○○
Symbol	Year	Month	Control number
SERIAL (Serial No.)			

The SERIAL consists of one symbol, two characters indicating the production year and month, and six characters indicating the control number. Last digit of the production year is indicated as the Year, and the Month is indicated by 1 to 9, X (October), Y (November), and Z (December).

MEMO

REVISIONS

*The manual number is given on the bottom left of the back cover.

Print Date	Manual Number	Revision
Mar. 2012	IB(NA)-0600477ENG-A	First edition
May 2012	IB(NA)-0600477ENG-B	[Modification] Change in the India FA Center address

 **For Maximum Safety**

- Mitsubishi drive units are not designed or manufactured to be used in equipment or systems in situations that can affect or endanger human life.
- When considering this product for operation in special applications such as machinery or systems used in passenger transportation, medical, aerospace, atomic power, electric power, or submarine repeating applications, please contact your nearest Mitsubishi sales representative.
- Although this product was manufactured under conditions of strict quality control, you are strongly advised to install safety devices to prevent serious accidents when it is used in facilities where breakdowns of the product are likely to cause a serious accident.
- Please do not use this product for loads other than the dedicated PM motor.

Additional notes for Instructions for UL and cUL

Motor overload protection

When using the electronic thermal relay function as motor overload protection, set the rated motor current in *Pr.9 Electronic thermal O/L relay*.

CAUTION

- Motor over temperature sensing is not provided by the drive.
-
-

General precaution

CAUTION - Risk of Electric Shock -

The bus capacitor discharge time is 10 minutes. Before starting wiring or inspection, switch power off, wait for more than 10 minutes.

ATTENTION - Risque de choc électrique -

La durée de décharge du condensateur de bus est de 10 minutes. Avant de commencer le câblage ou l'inspection, mettez l'appareil hors tension et attendez plus de 10 minutes.

Instructions for UL and cUL

Wiring protection

Integral solid state short circuit protection does not provide branch circuit protection. Branch circuit protection must be provided in accordance with the National Electrical Code for the U.S. or the Canadian Electrical Code for Canada and any additional codes. As specified, UL Class T ,Class J,Class CC fuses or any faster acting fuse with the appropriate rating or Listed UL 489 Molded Case Circuit Breaker (MCCB) must be employed.

International FA Center

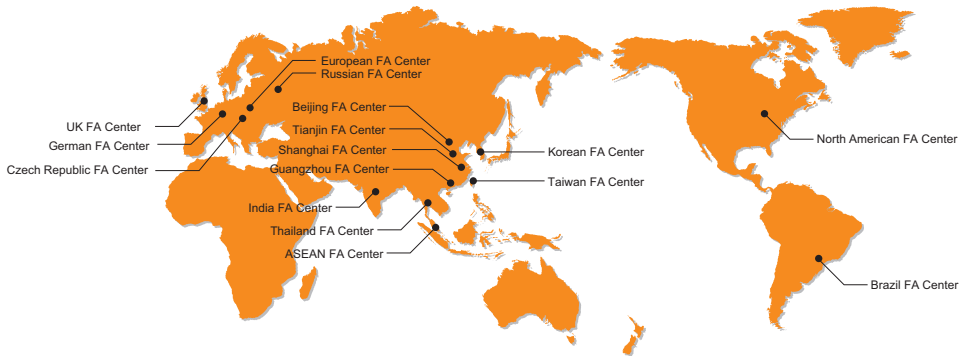

●Shanghai FA Center

MITSUBISHI ELECTRIC AUTOMATION (CHINA) LTD. Shanghai FA Center
3F, Mitsubishi Electric Automation Center, No.1386 Hongqiao Road, Changning District, Shanghai, China
TEL. 86-21-2322-3030 FAX. 86-21-2322-3000

●Beijing FA Center

MITSUBISHI ELECTRIC AUTOMATION (CHINA) LTD. Beijing FA Center
9F, Office Tower 1, Henderson Centre, 18 Jianguomennei Avenue, Dongcheng District, Beijing, China
TEL. 86-10-6518-8830 FAX. 86-10-6518-3907

●Tianjin FA Center

MITSUBISHI ELECTRIC AUTOMATION (CHINA) LTD. Tianjin FA Center
Unit 2003-2004B, Tianjin City Tower, No.35, You Yi Road, He Xi District, Tianjin, China
TEL 86-22-2813-1015 FAX. 86-22-2813-1017

●Guangzhou FA Center

MITSUBISHI ELECTRIC AUTOMATION (CHINA) LTD. Guangzhou FA Center
Room.1609, North Tower, The Hub Center, No.1068, Xin Gang East Road, Haizhu District, Guangzhou, China
TEL. 86-20-8923-6730 FAX. 86-20-8923-6715

●Korean FA Center

MITSUBISHI ELECTRIC AUTOMATION KOREA CO., LTD. (Service)
B1F,2F, 1480-6, Gangyong-Dong, Gangseo-Gu, Seoul, 157-200, Korea
TEL. 82-2-3660-9630 FAX. 82-2-3663-0475

●Taiwan FA Center

SETSUYO ENTERPRISE CO., LTD.
3F., No.105, Wugong 3 rd, Wugu Dist, New Taipei City 24889, Taiwan, R.O.C.
TEL. 886-2-2299-9917 FAX. 886-2-2299-9963

●ASEAN FA Center

MITSUBISHI ELECTRIC ASIA PTE, LTD.
ASEAN Factory Automation Centre
307 Alexandra Road #05-01/02, Mitsubishi Electric Building, Singapore
TEL. 65-6470-2480 FAX. 65-6476-7439

●India FA Center

MITSUBISHI ELECTRIC INDIA PVT. LTD.
India Factory Automation Centre
2nd Floor, Tower A & B, Cyber Greens, DLF Cyber City, DLF Phase-III, Gurgaon-122002 Haryana, India
TEL. 91-124-4630300 FAX. 91-124-4630399

●Thailand FA Center

MITSUBISHI ELECTRIC AUTOMATION (THAILAND) CO., LTD.
Bang-Chan Industrial Estate No.111, Soi Serithai 54, T.Kannayao, A.Kannayao, Bangkok 10230 Thailand
TEL. 66-2906-3238 FAX. 66-2906-3239

●North American FA Center

MITSUBISHI ELECTRIC AUTOMATION, INC.
500 Corporate Woods Parkway, Vernon Hills, IL 60061 U.S.A
TEL. 1-847-478-2334 FAX. 1-847-478-2253

●Brazil FA Center

MELCO-TEC Representacao Comercial e Assessoria Tecnica Ltda.
Av. Paulista, 1439, cj74, Bela Vista, Sao Paulo CEP: 01311-200 - SP Brazil
TEL. 55-11-3146-2200 FAX. 55-11-3146-2217

●European FA Center

MITSUBISHI ELECTRIC EUROPE B.V.
Polish Branch
Krakowska 50, 32-083 Balice, Poland
TEL. 48-12-630-4700 FAX. 48-12-630-4701

●German FA Center

MITSUBISHI ELECTRIC EUROPE B.V. - German Branch
Gothaer Strasse 8, D-40880 Ratingen, Germany
TEL. 49-2102-486-0 FAX. 49-2102-486-1120

●UK FA Center

MITSUBISHI ELECTRIC EUROPE B.V. UK Branch
Travellers Lane, Hatfield, Hertfordshire, AL10 8XB, U.K.
TEL. 44-1707-27-6100 FAX. 44-1707-27-8695

●Czech Republic FA Center

MITSUBISHI ELECTRIC EUROPE B.V. - o.s. Czech office
Avenir Business Park, Radlicka 714/113a, 158 00 Praha 5, Czech Republic
TEL. 420-251-551-470 FAX. 420-251-551-471

●Russian FA Center

MITSUBISHI ELECTRIC EUROPE B.V. Russian Branch
St.Petersburg office
Piskarevsky pr. 2, bld 2, lit "Sch", BC "Benua", office 720: 195027, St. Petersburg, Russia
TEL. 7-812-633-3497 FAX. 7-812-633-3499

MITSUBISHI ELECTRIC CORPORATION

HEAD OFFICE: TOKYO BUILDING 2-7-3, MARUNOUCHI, CHIYODA-KU, TOKYO 100-8310, JAPAN