



CompactBlock LDX I/O Analog Modules

Catalog Numbers 1790D-N4CO, 1790D-TN4CO, 1790D-TN4VO,
1790D-NOC2, 1790D-TNOC2, 1790D-TNOV2, 1790P-TN4CO,
1790P-TNOC2



Allen-Bradley

by ROCKWELL AUTOMATION

User Manual

Original Instructions

Important User Information

Read this document and the documents listed in the additional resources section about installation, configuration, and operation of this equipment before you install, configure, operate, or maintain this product. Users are required to familiarize themselves with installation and wiring instructions in addition to requirements of all applicable codes, laws, and standards.

Activities including installation, adjustments, putting into service, use, assembly, disassembly, and maintenance are required to be carried out by suitably trained personnel in accordance with applicable code of practice.

If this equipment is used in a manner not specified by the manufacturer, the protection provided by the equipment may be impaired.

In no event will Rockwell Automation, Inc. be responsible or liable for indirect or consequential damages resulting from the use or application of this equipment.

The examples and diagrams in this manual are included solely for illustrative purposes. Because of the many variables and requirements associated with any particular installation, Rockwell Automation, Inc. cannot assume responsibility or liability for actual use based on the examples and diagrams.

No patent liability is assumed by Rockwell Automation, Inc. with respect to use of information, circuits, equipment, or software described in this manual.

Reproduction of the contents of this manual, in whole or in part, without written permission of Rockwell Automation, Inc., is prohibited.

Throughout this manual, when necessary, we use notes to make you aware of safety considerations.



WARNING: Identifies information about practices or circumstances that can cause an explosion in a hazardous environment, which may lead to personal injury or death, property damage, or economic loss.



ATTENTION: Identifies information about practices or circumstances that can lead to personal injury or death, property damage, or economic loss. Attentions help you identify a hazard, avoid a hazard, and recognize the consequence.

IMPORTANT Identifies information that is critical for successful application and understanding of the product.

Labels may also be on or inside the equipment to provide specific precautions.



SHOCK HAZARD: Labels may be on or inside the equipment, for example, a drive or motor, to alert people that dangerous voltage may be present.



BURN HAZARD: Labels may be on or inside the equipment, for example, a drive or motor, to alert people that surfaces may reach dangerous temperatures.



ARC FLASH HAZARD: Labels may be on or inside the equipment, for example, a motor control center, to alert people to potential Arc Flash. Arc Flash will cause severe injury or death. Wear proper Personal Protective Equipment (PPE). Follow ALL Regulatory requirements for safe work practices and for Personal Protective Equipment (PPE).

	Preface	7
	About This Publication	7
	Who Should Use This Manual	7
	Download Firmware, AOP, EDS, and Other Files	7
	Summary of Changes	7
	Additional Resources	7
	 Chapter 1	
Overview	How to Use Analog I/O	9
	General Description	9
	Hardware Features	10
	General Diagnostic Features	10
	System Overview	11
	System Operation	11
	Module Operation	11
	 Chapter 2	
Installation and Wiring	Power Requirements	13
	General Considerations	13
	Reduce Noise	13
	Protect the Circuit Board from Contamination	14
	Install the CompactBlock LDX I/O	14
	Set the Node Address on the Base Block	14
	Mount the Base Block	14
	Mount the Optional Expansion Blocks	15
	Connect the DeviceNet Cable	16
	I/O System Wiring Guidelines	17
	General	17
	Input Modules	17
	Output Modules	17
	Effect of Transducer/Sensor and Cable Length Impedance on Voltage Input Accuracy	17
	Effect of Device and Cable Output Impedance on Output Module Accuracy	19
	Wiring the Modules	20
	1790D-N4Co Analog 4 Input Base D-shell Module Wiring	21
	1790D-TN4Co, 1790D-TN4Vo Analog 4 Input Base Module Wiring	21
	1790D-NoC2 Analog 2 Output Base D-shell Module Wiring	22
	1790D-TNoC2, 1790D-TNoV2 Analog 4 Input Base Module Wiring	23
	 Chapter 3	
Module Data, Status, and Channel Configuration for Analog Input Modules	Analog Input Image	25
	Analog Input Data File	25
	Analog Input Data File With Discrete Input Expansion Module ..	26
	Analog Input Data Format	29

	Configure Analog Input Module	29	
	Configure Analog Modules with RSNetWorx	29	
	Chapter 4		
Module Data, Status, and Channel Configuration for Analog Output Modules	Analog Output Image	33	
	Analog Output Data File	33	
	Analog Output Data File With Discrete Output Expansion Module	33	
	Analog Output Data Format	35	
	Output Fault and Idle States	36	
	Configure the Analog Output Module	36	
	Configure Analog Modules with RSNetWorx	36	
	Chapter 5		
Module Diagnostics and Troubleshooting	Safety Considerations	41	
	Status Indicator Lights	41	
	Activating Devices When Troubleshooting	41	
	Stand Clear of the Machine	41	
	Program Alteration	42	
	Safety Circuits	42	
	Module Operation vs. Channel Operation	42	
	Power-up Diagnostics	42	
	Module Status	42	
	Network Status	43	
	Channel Diagnostics	43	
	Out-of-Range Detection (Input Modules Only)	43	
	Open-Circuit Detection (Input Module Only)	43	
	Analog Input Module Error Definition Table	43	
	Module Errors	44	
	Channel Status Indicator Operation	44	
	Contacting Rockwell Automation	45	
		Appendix A	
	Install, Wire, and Configure PROFIBUS Modules	Power Requirements	47
Module Installation		47	
General Considerations		47	
Reducing Noise		47	
Protect the Circuit Board from Contamination		48	
Install the CompactBlock LDX I/O Block		48	
Set the Station Address on the Base Block		48	
Mount the Base Block		48	
Connect the PROFIBUS DP Terminal Connector		50	
Connect Power to the Block		51	
Connect I/O Wiring		51	
General Guidelines		51	
Guidelines for Input Modules		51	
Guidelines for Output Modules	51		
Wiring the Modules	52		

1790P-TN4Co Data Structure	53
Analog Input Image	53
1790P-TNOC2 Data Structure	54
Analog Output Image	54
Output Fault and Idle States	54
Configuring PROFIBUS Analog Modules	55
Configure Analog Modules with SST PROFIBUS Configuration Tool ..	55
Download the Configuration	58
Index	61

Notes:

About This Publication

Read this preface to familiarize yourself with the rest of the manual. This preface covers the following topics:

- who should use this manual
- how to use this manual
- related publications
- conventions used in this manual
- Rockwell Automation support

Who Should Use This Manual

Use this manual if you are responsible for designing, installing, programming, or troubleshooting control systems that use CompactBlock™ LDX I/O modules.

Download Firmware, AOP, EDS, and Other Files

Download firmware, associated files (such as AOP, EDS, and DTM), and access product release notes from the Product Compatibility and Download Center at rok.auto/pcdc.

Summary of Changes

This publication contains the following new or updated information. This list includes substantive updates only and is not intended to reflect all changes.

Topic	Page
Removed certification	13, 47
Updated template	throughout
Updated language style	throughout
Removed discontinued catalog numbers	throughout

Additional Resources

These documents contain additional information concerning related products from Rockwell Automation.

Resource	Description
DeviceNet Analog Base Terminal Block CompactBlock LDX I/O Installation Instructions, publication 1790-IN002	Provides detailed installation instructions for 1790D-TN4CO, 1790D-TNOC2, and 1790D-TN4VO
DeviceNet Analog Base D-shell CompactBlock LDX I/O Installation Instructions, publication 1790-IN004	Provides detailed installation instructions for 1790D-N4CO, 1790D-NOC2
DeviceNet Media Design Installation Guide, publication DNET-UM072	Provides guidance on the required components of the cable system and how to design for and install these required components.
System Security Design Guidelines Reference Manual, SECURE-RM001	Provides guidance on how to conduct security assessments, implement Rockwell Automation products in a secure system, harden the control system, manage user access, and dispose of equipment.
Industrial Components Preventive Maintenance, Enclosures, and Contact Ratings Specifications, publication IC-TD002	Provides a quick reference tool for Allen-Bradley® industrial automation controls and assemblies.
Safety Guidelines for the Application, Installation, and Maintenance of Solid-state Control, publication SGI-1.1	Designed to harmonize with NEMA Standards Publication No. ICS 11-1987 and provides general guidelines for the application, installation, and maintenance of solid-state control in the form of individual devices or packaged assemblies incorporating solid-state components.
Industrial Automation Wiring and Grounding Guidelines, publication 1770-4.1	Provides general guidelines for installing a Rockwell Automation industrial system.
Product Certifications website, rok.auto/certifications .	Provides declarations of conformity, certificates, and other certification details.

You can view or download publications at rok.auto/literature.

Notes:

Overview

This chapter explains how analog data is used, and describes CompactBlock LDX I/O analog input and output modules. Included is information about:

- the use of analog I/O
- the module hardware and diagnostic features
- an overview of the analog input system operation
- an overview of the analog output system operation

How to Use Analog I/O

Analog refers to the representation of numerical quantities by the measurement of continuous physical variables. Analog applications are present in many forms. The following application shows a typical use of analog data.

In this application, the processor controls the amount of fluid in a holding tank by adjusting the valve opening. The valve is initially open 100%. As the fluid level in the tank approaches the preset point, the processor modifies the output to close the valve 90%, 80%, and so on, continuously adjusting the valve to maintain the fluid level.

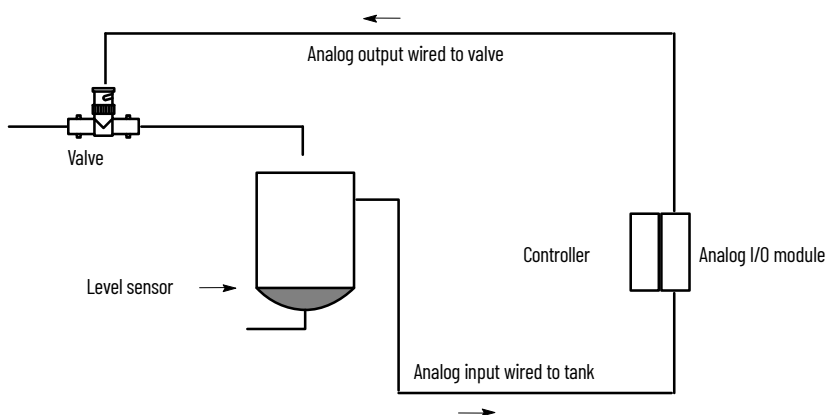

General Description

The analog input module converts and digitally stores analog data for retrieval by controllers, such as the SLC™ 500 programmable controller. The module supports connections from any combination of up to four voltage or current analog sensors. The four high-impedance input channels can be wired as single-ended inputs.

The output module provides two single-ended analog output channels, either voltage or current, depending on the module selected.

[Table 1](#) lists the CompactBlock LDX I/O module types and corresponding operating ranges:

Table 1 - CompactBlock LDX I/O Module Types and Operating Ranges

CompactBlock LDX I/O Module	Type:	Operating Range:
1790D-N4C0 1790D-TN4C0	Current input	4...20 mA or 0...20 mA
1790D-NOC2 1790D-TNOC2	Current output	0...20 mA
1790D-TN4V0	Voltage input	0...10V DC
1790D-TNOV2	Voltage output	0...10V DC

Each analog base module supports up to two CompactBlock LDX I/O discrete expansion modules.

Hardware Features

The modules contain either removable D-shell connectors or fixed terminal blocks. The CompactBlock LDX I/O module four input channels are single-ended. The CompactBlock LDX I/O module two output channels are also single-ended. Module configuration is normally done via the controller’s programming software. In addition, some controllers support configuration via the user program.

[Figure 1](#) shows the CompactBlock LDX I/O analog module hardware features.

Figure 1 - Hardware Features

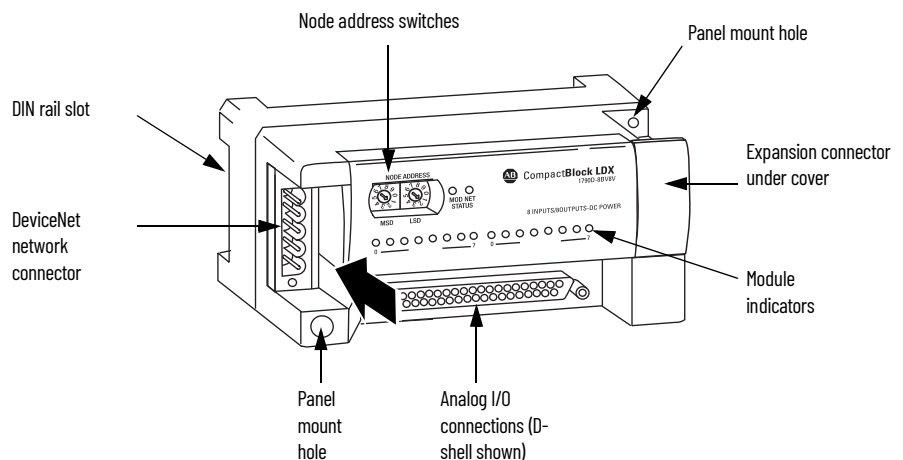

General Diagnostic Features

The CompactBlock LDX I/O modules contain diagnostic features that can help you identify the source of problems that may occur during power-up or during

normal channel operation. These power-up and channel diagnostics are explained in [Module Diagnostics and Troubleshooting on page 41](#).

System Overview

The modules communicate to the controller through the DeviceNet® network. Module power is derived from DeviceNet. Additionally, the analog I/O requires 24V DC field power separate from DeviceNet. CompactBlock LDX I/O analog bases support up to two discrete LDX expansion modules.

System Operation

At power-up, the analog base module performs a check of its internal circuits, memory, and basic functions. During this time, the module status indicator remains off. If no faults are found during power-up diagnostics, the module status indicator is turned on.

After power-up checks are complete, the module waits for valid channel configuration data. If an invalid configuration is detected, the module generates a configuration error. Once a channel is properly configured and enabled, it begins the analog-to-digital or digital-to-analog conversion process.

Module Operation

Input Module

The input module's input circuitry consists of four analog inputs multiplexed into one analog-to-digital (A/D) converter. The A/D converter reads the selected input signal and converts it to a digital value that is presented to the network. The multiplexer sequentially switches each input channel to the module's A/D converter. [Figure 2](#) shows a block diagram of the circuitry.

Figure 2 - Input Module Circuitry Block Diagram

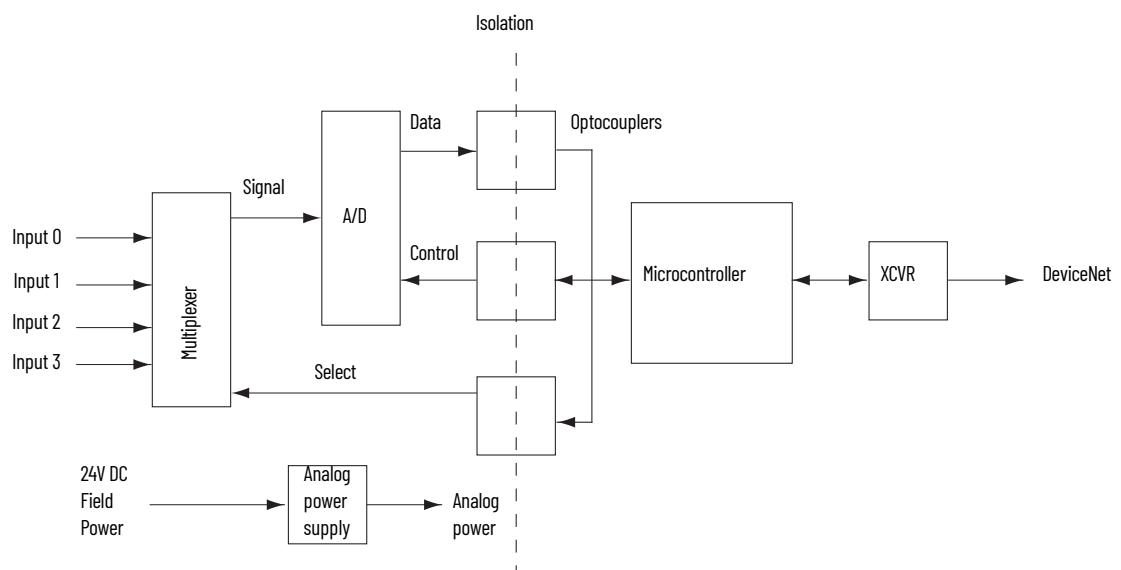

Each time the input module reads a channel, the module tests that analog data value for an overrange or underrange condition. If such a condition is detected, a unique bit is set in the channel status word. The channel status word is described in [Module Data, Status, and Channel Configuration for Analog Output Modules on page 33](#).

Output Module

The output module uses a digital-to-analog (D/A) converter to read the digital output data from the network and convert it to an analog output signal. [Figure 3](#) shows a block diagram of the circuitry.

Figure 3 - Output Module Circuitry Block Diagram

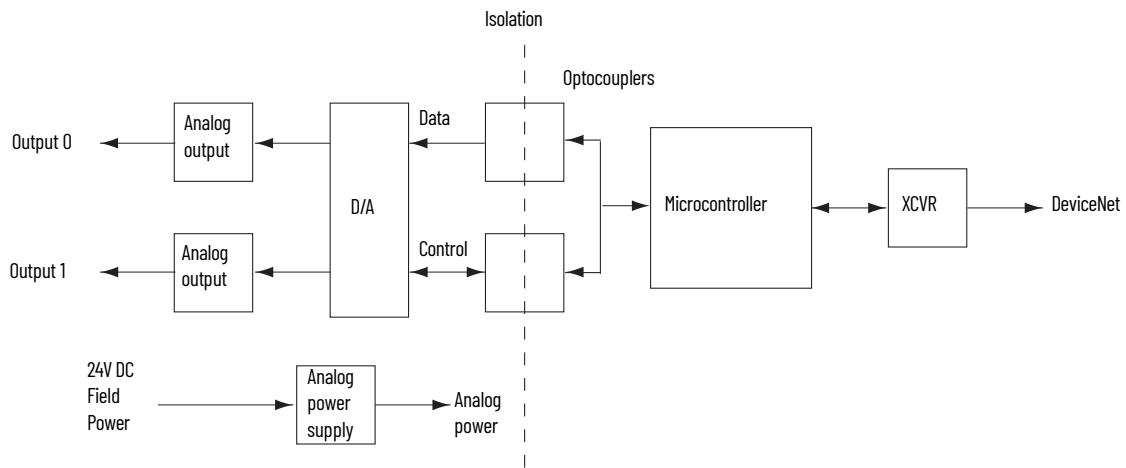

Installation and Wiring

This chapter tells you how to:

- determine the power requirements for the modules
- avoid electrostatic damage
- install the module
- wire the module's terminal block
- wire input devices
- wire output devices

Power Requirements

The modules receive power through the DeviceNet network and from an auxiliary 24V DC field supply. [Table 2](#) shows the maximum power that the modules draw.

Table 2 - CompactBlock LDX I/O Module Power Requirements

	Voltage Range	Power
DeviceNet Power	11...28.8 V DC	1.2 W @ 28.8V DC
Auxiliary 24V DC Field Power	21.6...26.4V DC	1.5 W @ 26.4V DC

General Considerations

Reduce Noise

Most applications require installation in an industrial enclosure to reduce the effects of electrical interference. Analog inputs and outputs are highly susceptible to electrical noise. Electrical noise coupled to the analog inputs reduces the performance (accuracy) of the module.

Group your modules in the enclosure to minimize adverse effects from radiated electrical noise and heat. Consider the following conditions when selecting a location for the analog module. Position the module:

- away from sources of electrical noise such as hard-contact switches, relays, and AC motor drives
- away from modules that generate significant radiated heat.

In addition, route shielded, twisted-pair analog input and output wiring away from any high-voltage I/O wiring.

Protect the Circuit Board from Contamination

The printed circuit boards of the analog modules must be protected from dirt, oil, moisture, and other airborne contaminants. To protect these boards, the system must be installed in an enclosure suitable for the environment. The interior of the enclosure should be kept clean and the enclosure door should be kept closed whenever possible.

Install the CompactBlock LDX I/O

Follow these steps to install the block:

1. [Set the Node Address on the Base Block](#)
2. [Mount the Base Block](#)
3. [Mount the Optional Expansion Blocks](#)
4. [Connect the DeviceNet Cable](#)

Set the Node Address on the Base Block

Each base block comes with its internal program set for node address 63. To reset the node address, adjust the switches on the front of the block. The two switches are most significant digit (MSD) and least significant digit (LSD). The switches can be set from 00 to 63.

The rotary switches are read at block power-up only. Switch settings from 64 to 99 cause the block to use the last valid node address stored internally.

Figure 4 - Node Address Settings

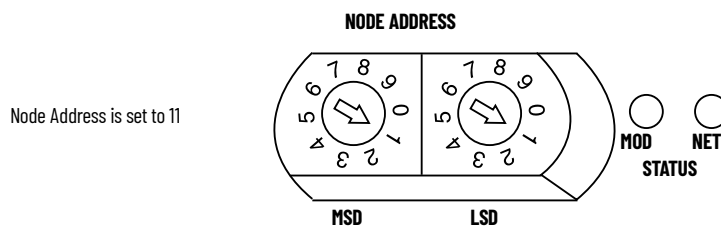

The node address may also be set through RSNetWorx™ for DeviceNet or a similar configuration tool. When software configuration is used for the node address, the switches must be set from 64 to 99.

Mount the Base Block

You can mount the base block to a panel or DIN rail. We recommend that you ground the panel or DIN rail before mounting the block.

IMPORTANT The analog base module can accommodate a **maximum** of two discrete expansion modules.



WARNING: When used in a Class I, Division 2, hazardous location, this equipment must be mounted in a suitable enclosure with proper wiring method that complies with the governing electrical codes.

Panel Mounting

1. Place the block against the panel where you want to mount it.
2. Gently pull and position the expansion cover to the left.
3. Place a center punch, nail, or similar device through the mounting holes in the block and make two marks on the panel (lower left and upper right corners of the module).
4. Remove the block and drill two holes in the panel to accommodate each of the mounting screws.
5. Replace the block on the panel and place a screw through each of the two mounting holes. Tighten the screws until the block is firmly in place.

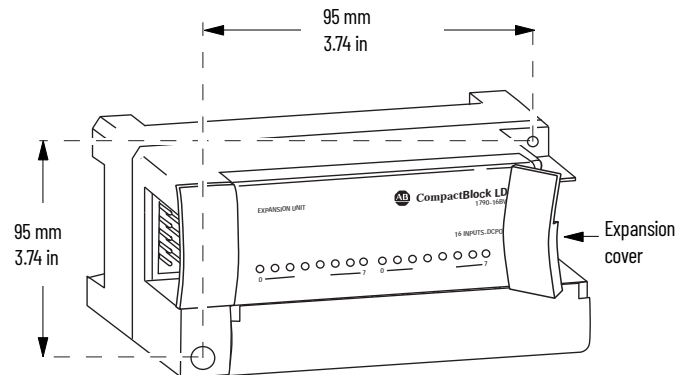

DIN Rail Mounting

1. Hook the top of slot of the block over the DIN Rail.
2. Pull down on the locking lever while pressing the block against the rail.

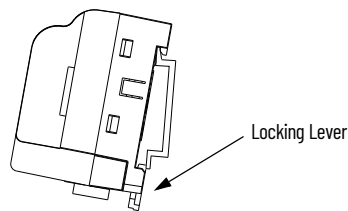

3. Push up on the locking lever to secure the block to the rail when block is flush against the rail.

Mount the Optional Expansion Blocks

Mount the expansion block by connecting it to a previously installed CompactBlock LDX I/O base or expansion block.

Beginning with the base block, you can mount your expansion blocks horizontally or vertically:

- horizontally (left to right) – add expansion blocks in an end-to-end configuration
- vertically (up or down) – add expansion blocks either up or down in a back-to-back configuration. In this configuration, you must use the optional 15 cm (5.90 in.) ribbon cable (1790-15CMCBL) and alternately position the blocks in a right-side up, upside-down fashion.

You can mount your blocks on a panel or DIN rail as described in the previous section.

Figure 5 - Module Mounting

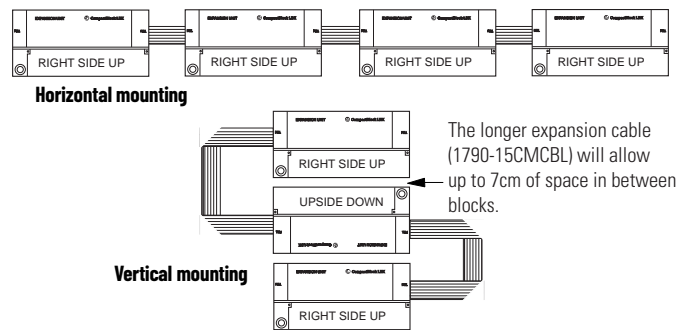

Connect the DeviceNet Cable

Follow these procedures when connecting the DeviceNet cable to the base block.

The required DeviceNet connector **is not supplied** with the block. You must purchase it separately. There are three types of connectors that you can order directly from Rockwell Automation or your local distributor:

- 1799-DNETCON – 5-position open style connector
- 1799-DNETSCON – 5-position open style connector with locking screws
- 1799-DNC5MMS – 5-position open style to 12 mm (0.47 in.) connector with locking screws



WARNING: If you connect or disconnect the DeviceNet cable with power applied to this module or any device on the network, an electrical arc can occur. This could cause an explosion in hazardous location installations. Be sure that power is removed or the area is nonhazardous before proceeding.

Connect the DeviceNet wiring (drop line) to one of the DeviceNet connectors as shown in [Figure 6](#). A color-coded wiring diagram is also printed next to the connector on the left side of the module.

Figure 6 - DeviceNet Wiring

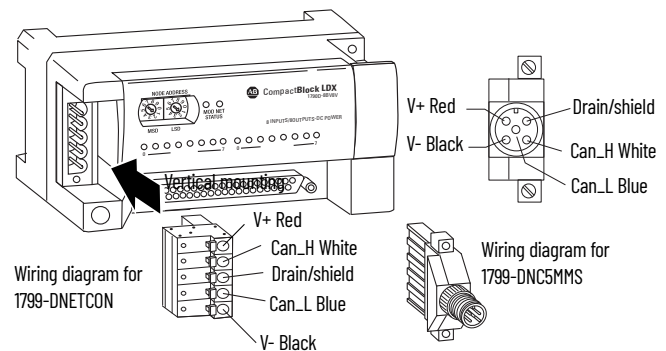

Once you have properly wired the drop line to the connector, attach the connector to the block. If applicable, use the locking screws on the connector to fasten it to the block.

I/O System Wiring Guidelines

Consider the following when wiring your system:

General

- All module commons (COM) are connected in the analog module. The analog common (COM) is not connected to earth ground inside the module.
- Channels are not isolated from each other.
- Do not use the analog module's NC terminals as connection points.
- To ensure optimum accuracy, limit overall cable impedance by keeping your cable as short as possible. Locate the I/O system as close to your sensors or actuators as your application permits.
- Use Belden 8761, or equivalent, shielded wire.
- Keep shield connection to ground as short as possible.
- Under normal conditions, the drain wire and shield junction must be connected to earth ground via a panel or DIN rail mounting screw at the analog I/O module end.⁽¹⁾

Input Modules

- If multiple power supplies are used with analog inputs, the power supply commons must be connected together.
- The module does not provide loop power for analog inputs. Use a power supply that matches the input transmitter specifications.

Output Modules

- Voltage outputs (CHO and CH1) of the 1790D-TNOV2 modules are referenced to COM. Load resistance for a voltage output channel must be equal to or greater than 1 K Ω .
- Current outputs (CHO and CH1) of the 1790D-NOC2 and 1790D-TNOC2 modules source current that returns to COM. Load resistance for a current output channel must remain between 0 and 600 Ω .

Effect of Transducer/Sensor and Cable Length Impedance on Voltage Input Accuracy

For voltage inputs, the length of the cable that is used between the transducer/sensor and the module can affect the accuracy of the data that is provided by the module.

(1) In environments where high-frequency noise may be present, it may be necessary to directly ground cable shields to earth at the module end and via a 0.1 μ F capacitor at the sensor end.

Figure 7 - Effect of Transducer/Sensor and Cable Length

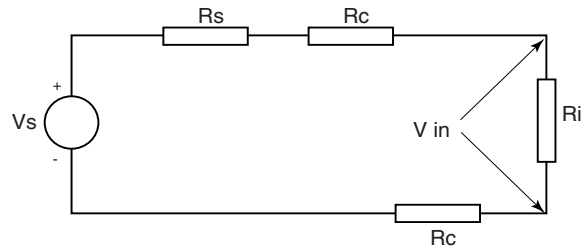

Where:

\$R_c\$ = DC resistance of the cable (each conductor) depending on cable length

\$R_s\$ = Source impedance of analog transducer/sensor output

\$R_i\$ = Impedance of the voltage input (500KΩ for 1790D-TN4VO)

\$V_s\$ = Voltage source (voltage at the transducer/sensor input device)

\$V_{in}\$ = Measured potential at the module input

%Ai = Percent added inaccuracy in a voltage-based system due to source and cable impedance.

$$V_{in} = \frac{[R_i \times V_s]}{[R_s + (2 \times R_c) + R_i]}$$

For example, for Belden 8761 two conductor, shielded cable:

$$R_c = 16 \Omega/1000 \text{ ft}$$

$$R_s = 0 \text{ (ideal source)}$$

$$\%Ai = \left(1 - \frac{V_{in}}{V_s} \right) \times 100$$

Table 3 - Effect of Cable Length on Input Accuracy

Length of Cable (m)	DC Resistance of Cable, \$R_c\$ (\$\Omega\$)	Accuracy Impact at Input Module
50	2.625	0.00105%
100	5.25	0.00210%
200	10.50	0.00420%
300	15.75	0.00630%

As input source impedance (\$R_s\$) and/or resistance (DC) of the cable (\$R_c\$) get larger, system accuracy decreases. If you determine that the inaccuracy error is significant, implement the following equation in the control program to compensate for the added inaccuracy error due to the impedance of the source and cable.

$$V_s = V_{in} \times \frac{[R_s + (2 \times R_c) + R_i]}{R_i}$$



In a current loop system, source and cable impedance do not impact system accuracy.

Effect of Device and Cable Output Impedance on Output Module Accuracy

The maximum value of the output impedance is shown in [Figure 8](#), because it creates the largest deviation from an ideal voltage source.

Figure 8 - Effect of Device and Cable Output Impedance

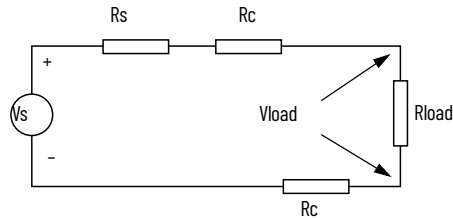

Where:

R_c = DC resistance of the cable (each conductor) depending on cable length

R_s = Source impedance of 1790D-TNOV2 (0.5 Ω)

R_{load} = Impedance of the load device

V_s = Voltage at the output of 1790D-TNOV2

V_{load} = Measured potential at the load device

$\%A_i$ = Percent added inaccuracy in a voltage-based system due to source and cable impedance.

$$V_{load} = \frac{[R_{load} \times V_s]}{[R_s + (2 \times R_c) + R_{load}]}$$

For example, for Belden 8761 two conductor, shielded cable and a 1790D-TNOV2 module:

$$R_c = 16 \Omega/1000 \text{ ft}$$

$$R_s = 0.5 \Omega$$

$$\%AV_{load} = \left(1 - \frac{V_{load}}{V_s}\right) \times 100$$

Table 4 - Effect of Output Impedance and Cable Length on Accuracy

Length of Cable (m)	DC resistance of the cable, R_c (Ω)	Accuracy impact at the load		
		1000 Ω	10,000 Ω	100,000 Ω
1	0.0525	0.0605%	0.00605%	0.000605%
10	0.525	0.155%	0.0155%	0.00155%
50	2.625	0.575%	0.0575%	0.00575%
100	5.25	1.1%	0.11%	0.011%

As output impedance (R_s) and/or resistance (DC) of the cable (R_c) get larger, system accuracy decreases. If you determine that the inaccuracy error is significant, implement the following equation in the control program to compensate for the added inaccuracy error due to the impedance of the output module and cable.

$$V_s = V_{load} \times \frac{[R_s + (2 \times R_c) + R_{load}]}{[R_{load}]}$$



In a current loop system, source and cable impedance do not impact system accuracy.

Wiring the Modules



ATTENTION: To prevent shock hazard, care should be taken when wiring the module to analog signal sources. Before wiring any analog module, disconnect power from the system power supply and from any other source to the analog module.

After the analog module is properly installed, follow the wiring procedure below. To ensure proper operation and high immunity to electrical noise, always use Belden 8761 (shielded, twisted-pair) or equivalent wire.



ATTENTION: Never connect a voltage or current source to an analog output channel.

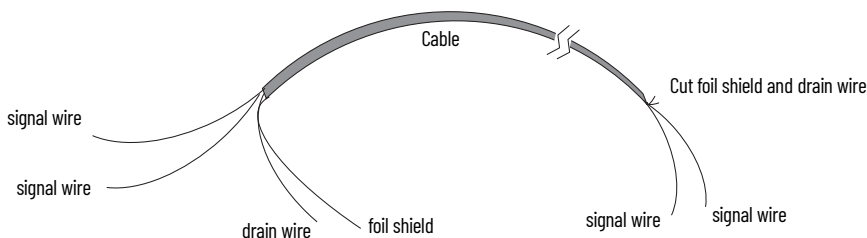

To wire your module, follow these steps.

1. At each end of the cable, strip some casing to expose the individual wires.
2. Trim the signal wires to 5.08 cm (2 in.) lengths. Strip about 5 mm (3/16 in.) of insulation away to expose the end of the wire.



ATTENTION: Be careful when stripping wires. Wire fragments that fall into a module could cause damage at power-up.

3. At one end of the cable, twist the drain wire and foil shield together.

Under normal conditions, this drain wire and shield junction must be connected to earth ground, through a panel or DIN rail mounting screw at the analog I/O module end. Keep the length of the drain wire as short as possible.

In environments where high frequency noise is present, ground the cable shields to earth at the module and via a 0.1 μ F capacitor at the sensor end for analog inputs and at the load end for analog outputs.

4. At the other end of the cable, cut the drain wire and foil shield back to the cable.

5. Connect the signal wires to the terminal block as shown in analog input wiring on [page 21](#) and [page 21](#) and analog output wiring on [page 22](#) and [page 23](#).
6. Connect the other end of the cable to the analog input or output device.
7. Repeat steps 1...5 for each channel on the module.

1790D-N4C0 Analog 4 Input Base D-shell Module Wiring

[Table 5](#) lists the module pin descriptions. [Figure 9](#) shows how to wire the module.

Table 5 - 1790D-N4C0 Module Pin Descriptions

Pin Number	1	2	3	4	5	6	7	8	9	10
Description	NC	NC	NC	NC	NC	CH3	NC	CH2	NC	CH1
Pin Number	11	12	13	14	15	16	17	18	19	20
Description	NC	CHO	NC	NC	NC	NC	+24V	+24V	+24V	NC
Pin Number	21	22	23	24	25	26	27	28	29	30
Description	NC	NC	NC	COM	NC	COM	NC	COM	NC	COM
Pin Number	31	32	33	34	35	36	37			
Description	NC	NC	NC	NC	GND	GND	GND			

NC = No Connect +24V = Field Power (+) 24V DC GND = Field Power (-) GND

Figure 9 - Example of Input Wiring to the 1790D-N4C0 Module

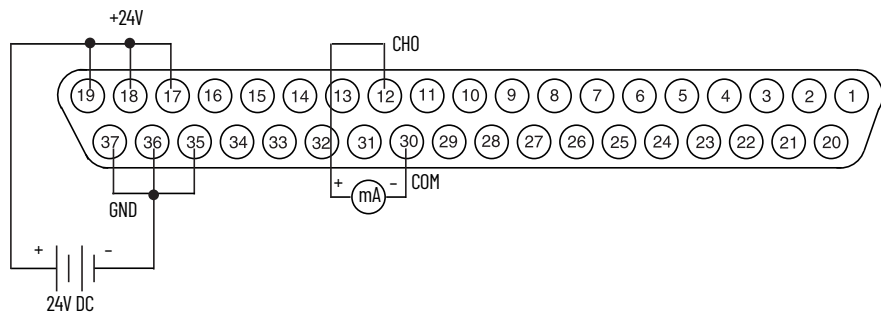

1790D-TN4C0, 1790D-TN4V0 Analog 4 Input Base Module Wiring

[Table 6](#) lists the module pin descriptions. [Figure 10](#) and [Figure 11](#) show how to wire each module.

Table 6 - 1790D-TN4C0 and 1790D-TN4V0 Module Pin Description

Pin Number	1	2	3	4	5	6	7	8	9	10
Description	+24V	GND	CHO	COM	CH1	COM	CH2	COM	CH3	COM

Table 6 - 1790D-TN4CO and 1790D-TN4VO Module Pin Description (Continued)

Pin Number	1	2	3	4	5	6	7	8	9	10
Pin Number	11	12	13	14	15	16	17	18	19	20
Description	NC	NC	NC	NC	NC	NC	NC	NC	NC	NC

+24V = Field Power (+) 24V DC GND = Field Power (-) GND

Figure 10 - Example of Input Wiring to the 1790D-TN4CO Module

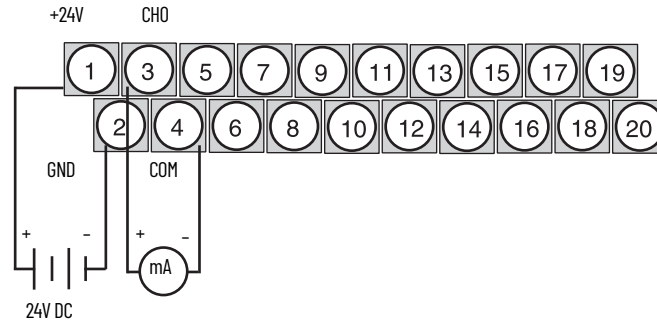
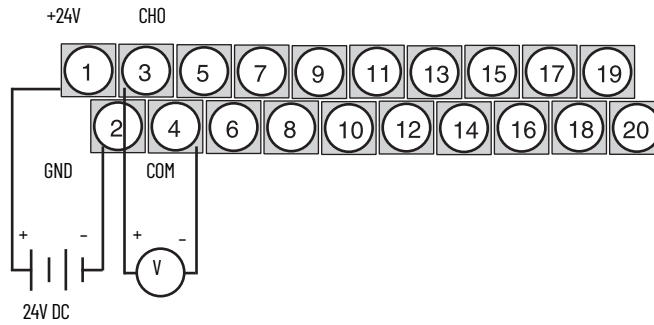

Figure 11 - Example of Input Wiring to the 1790D-TN4VO Module



1790D-NOC2 Analog 2 Output Base D-shell Module Wiring

Table 7 lists the module pin descriptions. Figure 12 shows how to wire each module.

Table 7 - 1790D-NOC2 Module Pin Description

Pin Number	1	2	3	4	5	6	7	8	9	10
Description	NC	NC	NC	NC	NC	NC	NC	NC	NC	CH1
Pin Number	11	12	13	14	15	16	17	18	19	20
Description	NC	CHO	NC	NC	NC	NC	+24V	+24V	+24V	NC
Pin Number	21	22	23	24	25	26	27	28	29	30
Description	NC	NC	NC	NC	NC	NC	NC	COM	NC	COM
Pin Number	31	32	33	34	35	36	37			
Description	NC	NC	NC	NC	GND	GND	GND			

NC = No Connect +24V = Field Power (+) 24V DC GND = Field Power (-) GND

Figure 12 - Example of Input Wiring to the 1790D-NOC2 Module

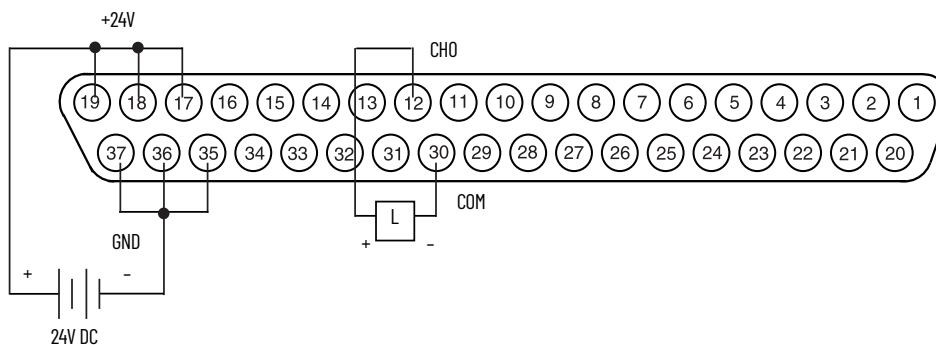

1790D-TNOC2, 1790D-TNOV2 Analog 4 Input Base Module Wiring

Table 8 lists the module pin descriptions. Figure 13 shows how to wire each module.

Table 8 - 1790D-TNOC2 and 1790D-TNOV2 Module Pin Description

Pin Number	1	2	3	4	5	6	7	8	9	10
Description	+24V	GND	CHO	COM	CH1	COM	NC	NC	NC	NC
Pin Number	11	12	13	14	15	16	17	18	19	20
Description	NC	NC	NC	NC	NC	NC	NC	NC	NC	NC

+24V = Field Power (+) 24V DC GND = Field Power (-) GND

Figure 13 - Example of Input Wiring to the 1790D-TNOC2 and 1790D-TNOV2 Module

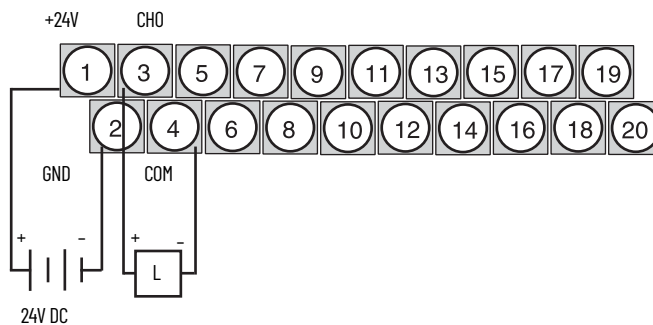

Notes:

Module Data, Status, and Channel Configuration for Analog Input Modules

This chapter examines the analog input module’s data table, channel status, and channel configuration.

Analog Input Image

The input image file represents data words and status bits. Input words 0...3 hold the input data that represents the value of the analog inputs for channels 0...3. These data words are valid only when the channel is enabled and there are no errors. Input word 4 holds the status bits. Analog input data is presented as raw/proportional.

Input words 5 and 6 contain input data for two optional discrete input expansion modules.

1790D-N4CO and 1790D-TN4CO Configuration

Each analog current input can be configured for either the 4...20 mA or 0...20 mA range. See [Configure Analog Modules with RSNetWorx on page 29](#) for instructions.

Analog Input Data File

The input data table allows you to access analog input module and data for use in the control program, through word and bit access. [Table 9](#) shows the data table structure.

Table 9 - 1790D-N4CO, 1790D-TN4CO, 1790D-TN4VO Input Data File

Word	Bit Position														
	15	14	13	12	11	10	9	8	7	6	5	4	3	2	1
0	Not Used				Analog Input Data Channel 0										
1	Not Used				Analog Input Data Channel 1										
2	Not Used				Analog Input Data Channel 2										
3	Not Used				Analog Input Data Channel 3										
4	Not Used											S3	S2	S1	S0

Table 10 - Word/Bit Description

Word	Decimal Bit	Description
Read Word 0	Bits 00...11	Channel 0 input data
	Bits 12...15	Not used: Set to 0
Read Word 1	Bits 00...11	Channel 1 input data
	Bits 12...15	Not used: Set to 0
Read Word 2	Bits 00...11	Channel 2 input data
	Bits 12...15	Not used: Set to 0
Read Word 3	Bits 00...11	Channel 3 input data
	Bits 12...15	Not used: Set to 0
Read Word 4	Bits 00...03	Status bits for individual channels – Bit 00 corresponds to input channel 0, bit 01 corresponds to input channel 1 and so on. When set (1) indicates: No field power Open wire – 4...20 mA current input only Under range – 4...20 mA current input only Recoverable module fault (whole channel to be set) Unrecoverable module fault (whole channel to be set)
	Bits 04...15	Not used: Set to 0

Analog Input Data File With Discrete Input Expansion Module

Table 11 shows the structure for an analog base module with one of the following 8-input modules:

- 1790-8BV8BX, 1790-T8BV8BX
- 1790-T8AoX discrete expansion module.

Table 11 - 1790D-N4CO, 1790D-TN4CO, 1790D-TN4VO Input Data File with 8-Bit Discrete Expansion Module

Word	Bit Position															
	15	14	13	12	11	10	9	8	7	6	5	4	3	2	1	0
0	Not Used				Analog Input Data Channel 0											
1	Not Used				Analog Input Data Channel 1											
2	Not Used				Analog Input Data Channel 2											
3	Not Used				Analog Input Data Channel 3											
4	Not Used												S3	S2	S1	S0
5	Not Used								D7	D6	D5	D4	D3	D2	D1	D0

Table 12 - Word/Bit Description

Word	Decimal Bit	Description
Read Word 0	Bits 00...11	Channel 0 input data
	Bits 12...15	Not used: Set to 0
Read Word 1	Bits 00...11	Channel 1 input data
	Bits 12...15	Not used: Set to 0
Read Word 2	Bits 00...11	Channel 2 input data
	Bits 12...15	Not used: Set to 0
Read Word 3	Bits 00...11	Channel 3 input data
	Bits 12...15	Not used: Set to 0

Table 12 - Word/Bit Description (Continued)

Word	Decimal Bit	Description
Read Word 4	Bits 00...03	Status bits for individual channels – Bit 00 corresponds to input channel 0, bit 01 corresponds to input channel 1 and so on. When set (1) indicates: No field power Open wire – 4...20 mA current input only Under range – 4...20 mA current input only Recoverable module fault (whole channel to be set) Unrecoverable module fault (whole channel to be set)
	Bits 04...15	Not used: Set to 0
Read Word 5	Bits 00...07	Discrete Input expansion data
	Bits 08...15	Not Used

Table 13 shows the structure for an analog base module with two of the following 8-input modules:

- 1790-8BV8BX, 1790-T8BV8BX modules,
- 1790-T8AoX discrete expansion modules

or one of the following 16-input modules:

- 1790-16BV0X, 1790-T16BV0X discrete expansion modules

Table 13 - 1790D-N4C0, 1790D-TN4C0, 1790D-TN4V0 Input Data File with 16-Bit Discrete Expansion Module

Word	Bit Position															
	15	14	13	12	11	10	9	8	7	6	5	4	3	2	1	0
0	Not Used											Analog Input Data Channel 0				
1	Not Used											Analog Input Data Channel 1				
2	Not Used											Analog Input Data Channel 2				
3	Not Used											Analog Input Data Channel 3				
4	Not Used											S3	S2	S1	S0	
5	D15	D14	D13	D12	D11	D10	D9	D8	D7	D6	D5	D4	D3	D2	D1	D0

Table 14 - Word/Bit Description

Word	Decimal Bit	Description
Read Word 0	Bits 00...11	Channel 0 input data
	Bits 12...15	Not used: Set to 0
Read Word 1	Bits 00...11	Channel 1 input data
	Bits 12...15	Not used: Set to 0
Read Word 2	Bits 00...11	Channel 2 input data
	Bits 12...15	Not used: Set to 0
Read Word 3	Bits 00...11	Channel 3 input data
	Bits 12...15	Not used: Set to 0
Read Word 4	Bits 00...03	Status bits for individual channels – Bit 00 corresponds to input channel 0, bit 01 corresponds to input channel 1 and so on. When set (1) indicates: No field power Open wire – 4...20 mA current input only Under range – 4...20 mA current input only Recoverable module fault (whole channel to be set) Unrecoverable module fault (whole channel to be set)
	Bits 04...15	Not used: Set to 0
Read Word 5	Bits 00...15	Discrete Input expansion data

Table 15 shows the structure for an analog base module with one of the following 16-input modules:

- 1790-16BV0X, 1790-T16BV0X discrete expansion module

and one of the following 8-input modules:

- 1790-8BV8BX, 1790-T8BV8BX discrete expansion module
- 1790-8BV8VX, 1790-T8BVX discrete expansion module
- 1790-T8AoX discrete expansion module

Table 15 - 1790D-N4C0, 1790D-TN4C0, 1790D-TN4V0 Input Data File with 24-Bit Discrete Expansion Module

Word	Bit Position															
	15	14	13	12	11	10	9	8	7	6	5	4	3	2	1	0
0	Not Used				Analog Input Data Channel 0											
1	Not Used				Analog Input Data Channel 1											
2	Not Used				Analog Input Data Channel 2											
3	Not Used				Analog Input Data Channel 3											
4	Not Used												S3	S2	S1	S0
5	D15	D14	D13	D12	D11	D10	D9	D8	D7	D6	D5	D4	D3	D2	D1	D0
6	Not Used								D23	D22	D21	D20	D19	D18	D17	D16

Table 16 - Word/Bit Description

Word	Decimal Bit	Description
Read Word 0	Bits 00...11	Channel 0 input data
	Bits 12...15	Not used: Set to 0
Read Word 1	Bits 00...11	Channel 1 input data
	Bits 12...15	Not used: Set to 0
Read Word 2	Bits 00...11	Channel 2 input data
	Bits 12...15	Not used: Set to 0
Read Word 3	Bits 00...11	Channel 3 input data
	Bits 12...15	Not used: Set to 0
Read Word 4	Bits 00...03	Status bits for individual channels – Bit 00 corresponds to input channel 0, bit 01 corresponds to input channel 1 and so on. When set (1) indicates: No field power Open wire – 4...20 mA current input only Under range – 4...20 mA current input only Recoverable module fault (whole channel to be set) Unrecoverable module fault (whole channel to be set)
	Bits 04...15	Not used: Set to 0
Read Word 5	Bits 00...15	First discrete Input expansion data
Read Word 6	Bits 00...07	Second discrete Input expansion data
	Bits 08...15	Not Used

Table 17 shows the structure for an analog base module with two 16-input 1790-16BVoX, 1790-T16BVoX discrete expansion modules.

Table 17 - 1790D-N4C0, 1790D-TN4C0, 1790D-TN4V0 Input Data File with 32-Bit Discrete Expansion Module

Word	Bit Position															
	15	14	13	12	11	10	9	8	7	6	5	4	3	2	1	0
0	Not Used				Analog Input Data Channel 0											
1	Not Used				Analog Input Data Channel 1											
2	Not Used				Analog Input Data Channel 2											
3	Not Used				Analog Input Data Channel 3											
4	Not Used												S3	S2	S1	S0
5	D15	D14	D13	D12	D11	D10	D9	D8	D7	D6	D5	D4	D3	D2	D1	D0
6	D31	D30	D29	D28	D27	D26	D25	D24	D23	D22	D21	D20	D19	D18	D17	D16

Table 18 - Word/Bit Descriptions

Word	Decimal Bit	Description
Read Word 0	Bits 00...11	Channel 0 input data
	Bits 12...15	Not used: Set to 0

Table 18 - Word/Bit Descriptions (Continued)

Word	Decimal Bit	Description
Read Word 1	Bits 00...11	Channel 1 input data
	Bits 12...15	Not used: Set to 0
Read Word 2	Bits 00...11	Channel 2 input data
	Bits 12...15	Not used: Set to 0
Read Word 3	Bits 00...11	Channel 3 input data
	Bits 12...15	Not used: Set to 0
Read Word 4	Bits 00...03	Status bits for individual channels – Bit 00 corresponds to input channel 0, bit 01 corresponds to input channel 1 and so on. When set (1) indicates: No field power Open wire – 4...20 mA current input only Under range – 4...20 mA current input only Recoverable module fault (whole channel to be set) Unrecoverable module fault (whole channel to be set)
	Bits 04...15	Not used: Set to 0
Read Word 5	Bits 00...15	First discrete Input expansion data
Read Word 6	Bits 00...15	Second discrete Input expansion data

Analog Input Data Format

Analog input data is presented as raw or proportional. The full 12-bit resolution is used over the entire span of the input full scale range, as shown in [Table 19](#).

Table 19 - Bit Resolution

Module	Input Full Scale Range	HEX Data Range	Decimal Data Range	Input Resolution
1790D-TN4V0	0...10V DC	0000...0FFF	0...4095	2.44 mV
1790D-N4C0 1790D-TN4C0	4...20 mA	0000...0FFF	0...4095	3.90 μ A
	0...20 mA	0000...0FFF	0...4095	4.88 μ A

Configure Analog Input Module

RSNetWorx for DeviceNet allows you to identify the network and configure the I/O modules with easy-to-use Electronic Data Sheets (EDS). Point to the field and click your selection.

To download EDS files for use in configuration, go to rok.auto/pcdc.

EDS files for blocks with matching catalog numbers (for D-shell and removable terminal block versions) are the same. The website, or in RSNetWorx for DeviceNet, there may be only one catalog number that is listed for both versions.

When using third-party configuration software, load the EDS files into the software and follow the vendor's instructions.

Configure Analog Modules with RSNetWorx

To configure analog modules, follow these steps:

1. Open RSNetWorx for DeviceNet.
2. Add an analog input module (for example, 1790D-N4C0) to the network, as shown in [Figure 14](#).

Figure 14 - Add module in RSNetWorx for DeviceNet

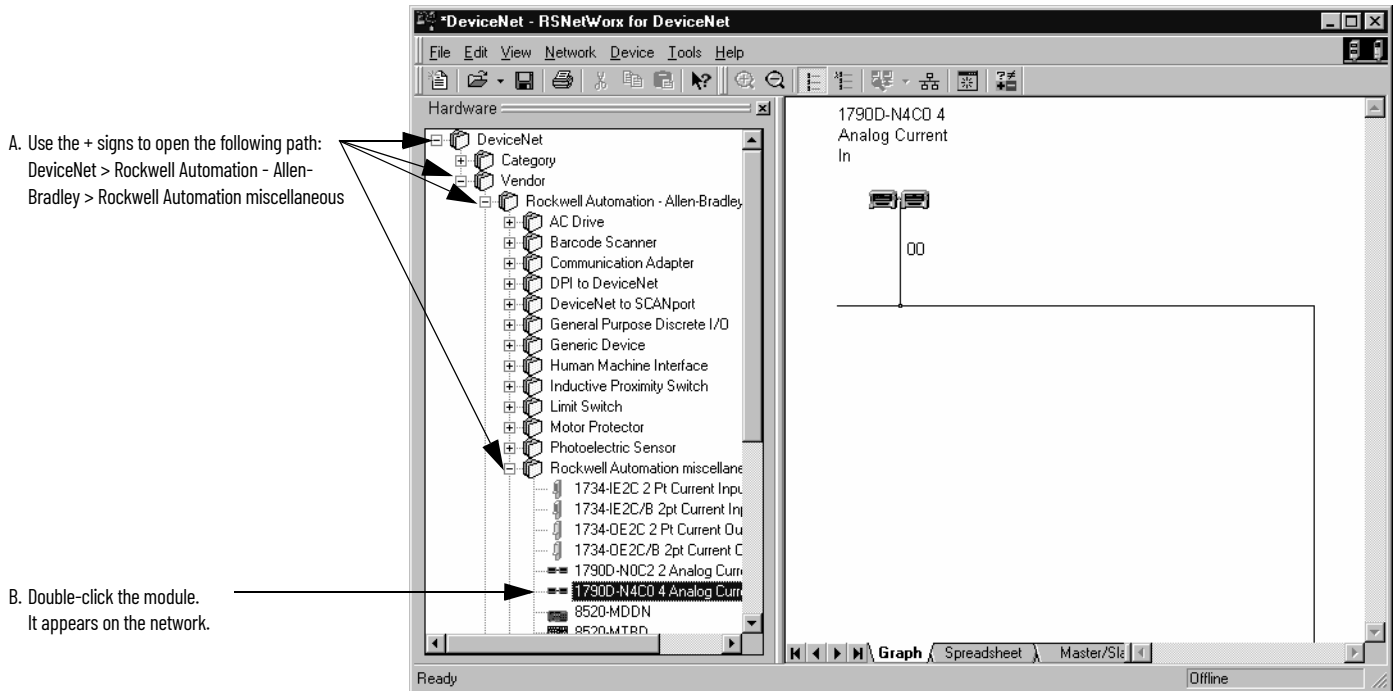

3. Double-click the module icon on the DeviceNet network. If you are online, upload the configuration and existing module parameters are shown. A dialog box similar to [Figure 15](#) displays.

Figure 15 - General Module Properties

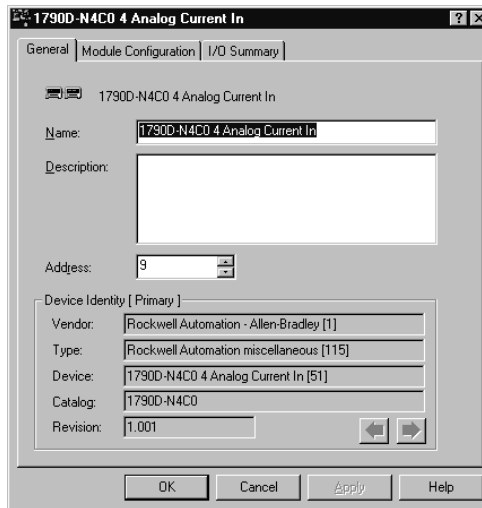

4. Click the Module Configuration tab. Analog input modules have a configuration dialog box similar to the dialog box shown in [Figure 16](#) for the 1790D-N4Co module.

Figure 16 - Module Configuration Tab

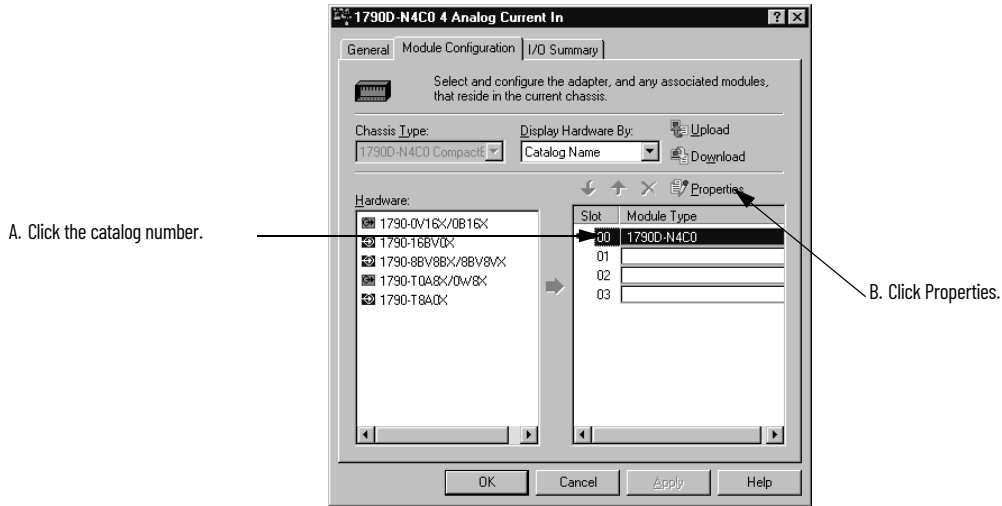

Use the Parameters tab to change module configuration. [Figure 17](#) shows how to change an AMP range selection.

Figure 17 - Parameters Tab

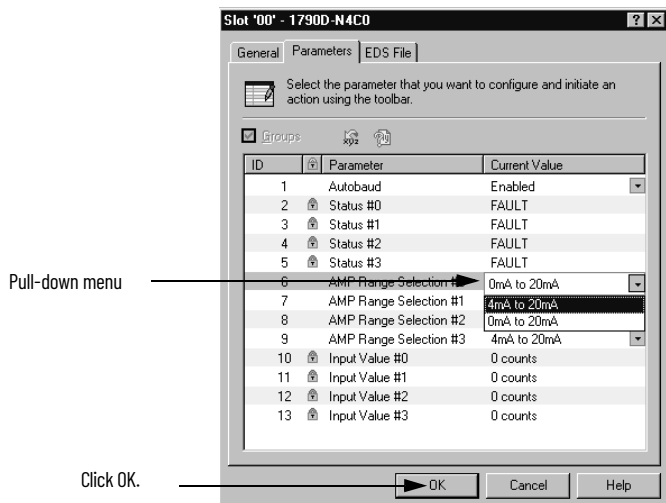

1. Use the pull-down menu to change range selection.
2. Click OK after making all configuration changes.

The Module Configuration dialog box displays.



3. Click Download to save your configuration.
4. Click OK after making all configuration changes.

Module Data, Status, and Channel Configuration for Analog Output Modules

This chapter examines the analog output module’s output data file and configuration.

Analog Output Image

The output image file represents data words. Output words 0 and 1 hold the output data that represents the value of the analog outputs for channels 0 and 1. Analog output data is presented as raw or proportional.

Output words 2 and 3 contain output data for two optional discrete output expansion modules.

Analog Output Data File

The structure of the output data file is shown.

Table 20 - 1790D-NOC2, 1790D-TNOC2, 1790D-TNOV2 Output Data File

Word	Bit Position															
	15	14	13	12	11	10	9	8	7	6	5	4	3	2	1	0
0	Not Used					Analog Output Data Channel 0										
1	Not Used					Analog Output Data Channel 1										

Table 21 - Word/Bit Description

Word	Decimal Bit	Description
Write Word 0	Bits 00...11	Channel 0 output data
	Bits 12...15	Not used: Set to 0
Write Word 1	Bits 00...11	Channel 1 output data
	Bits 12...15	Not used: Set to 0

Analog Output Data File With Discrete Output Expansion Module

[Table 22](#) shows the structure for an analog base module with one of the following 8-output modules:

- 1790-8BV8BX, 1790-T8BV8BX discrete expansion module
- 1790-8BV8VX, 1790-T8BV8VX discrete expansion module
- 1790-TOA8X discrete expansion module
- 1790-ToW8X discrete expansion module.

Table 22 - 1790D-NOC2, 1790D-TNOC2, 1790D-TNOV2 Output Data File with 8-Bit Discrete Expansion Module

Word	Bit Position														
	15	14	13	12	11	10	9	8	7	6	5	4	3	2	1
0	Not Used				Analog Output Data Channel 0										
1	Not Used				Analog Output Data Channel 1										
2	Not Used							D7	D6	D5	D4	D3	D2	D1	D0

Table 23 - Word/Bit Descriptions

Word	Decimal Bit	Description
Write Word 0	Bits 00...11	Channel 0 output data
	Bits 12...15	Not used: Set to 0
Write Word 1	Bits 00...11	Channel 1 output data
	Bits 12...15	Not used: Set to 0
Write Word 2	Bits 00...07	Discrete output expansion data
	Bits 08...15	Not used: Set to 0

Table 24 shows the structure for an analog base module with one of the following 16-output modules:

- 1790-OB16X, 1790-TOB16X discrete expansion module
- 1790-OV16X, 1790-TOV16X discrete expansion module

or two of the following 8-output modules:

- 1790-8BV8BX, 1790-T8BV8BX discrete expansion modules
- 1790-8BV8VX, 1790-T8BV8VX discrete expansion modules
- 1790-TOA8X discrete expansion modules

Table 24 - 1790-TOW8X Discrete Expansion Module 1790D-NOC2, 1790D-TNOC2, 1790D-TNOV2 Output Data File with 16-Bit Discrete Expansion Module

Word	Bit Position															
	15	14	13	12	11	10	9	8	7	6	5	4	3	2	1	0
0	Not Used				Analog Output Data Channel 0											
1	Not Used				Analog Output Data Channel 1											
2	D15	D14	D13	D12	D11	D10	D9	D8	D7	D6	D5	D4	D3	D2	D1	D0

Table 25 - Word/Bit Description

Word	Decimal Bit	Description
Write Word 0	Bits 00...11	Channel 0 output data
	Bits 12...15	Not used: Set to 0
Write Word 1	Bits 00...11	Channel 1 output data
	Bits 12...15	Not used: Set to 0
Write Word 2	Bits 00...15	Discrete output expansion data

Table 26 shows the structure for an analog base module with one of the following 16-output modules:

- 1790-OB16X, 1790-TOB16X discrete expansion module
- 1790-OV16X, 1790-TOV16X discrete expansion module

and with one of the following 8-input modules

- 1790-8BV8BX, 1790-T8BV8BX discrete expansion module
- 1790-8BV8VX, 1790-T8BV8VX discrete expansion module
- 1790-TOA8X discrete expansion module

- 1790-TOW8X discrete expansion module

Table 26 - 1790D-N4C0, 1790D-TN4C0, 1790D-TN4V0 Output Data File with 24-Bit Discrete Expansion Module

Word	Bit Position															
	15	14	13	12	11	10	9	8	7	6	5	4	3	2	1	0
0	Not Used				Analog Output Data Channel 0											
1	Not Used				Analog Output Data Channel 1											
2	D15	D14	D13	D12	D11	D10	D9	D8	D7	D6	D5	D4	D3	D2	D1	D0
3	Not Used								D23	D22	D21	D20	D19	D18	D17	D16

Table 27 - Word/Bit Description

Word	Decimal Bit	Description
Write Word 0	Bits 00...11	Channel 0 output data
	Bits 12...15	Not used: Set to 0
Write Word 1	Bits 00...11	Channel 1 output data
	Bits 12...15	Not used: Set to 0
Write Word 2	Bits 00...15	First discrete output expansion data
Write Word 3	Bits 00...07	Second discrete output expansion data
	Bits 08...15	Not used: Set to 0

[Table 28](#) shows the structure for an analog base module with two of the following 16-output modules:

- 1790-OB16X, 1790-TOB16X discrete expansion modules
- 1790-OV16X, 1790-TOV16X discrete expansion modules

Table 28 - 1790D-N4C0, 1790D-TN4C0, 1790D-TN4V0 Output Data File with 32-Bit Discrete Expansion Module

Word	Bit Position															
	15	14	13	12	11	10	9	8	7	6	5	4	3	2	1	0
0	Not Used				Analog Output Data Channel 0											
1	Not Used				Analog Output Data Channel 1											
2	D15	D14	D13	D12	D11	D10	D9	D8	D7	D6	D5	D4	D3	D2	D1	D0
3	D31	D30	D29	D28	D27	D26	D25	D24	D23	D22	D21	D20	D19	D18	D17	D16

Table 29 - Word/Bit Description

Word	Decimal Bit	Description
Write Word 0	Bits 00...11	Channel 0 output data
	Bits 12...15	Not used: Set to 0
Write Word 1	Bits 00...11	Channel 1 output data
	Bits 12...15	Not used: Set to 0
Write Word 2	Bits 00...15	First discrete output expansion data
Write Word 3	Bits 00...15	Second discrete output expansion data

Analog Output Data Format

Analog output data is presented as raw/proportional. The full 12-bit resolution is used over the entire span of the output full scale range, as shown in [Table 30](#).

Table 30 - Bit Resolution

Module	Output Full Scale Range	HEX Data Range	Decimal Data Range	Output Resolution
1790D-TNOV2	0...10V DC	0000...0FFF	0...4095	2.44 mV
1790D-NOC2 1790D-TNOC2	0...20 mA	0000...0FFF	0...4095	4.88 μ A

Output Fault and Idle States

Analog output fault (communication failure) and idle (processor in program mode) state can be defined for each output. Both fault state and idle state can have the behavior that is defined in [Table 31](#) for each output.

Table 31 - Output Fault/Idle State

Behavior	1790D-NOc2, 1790D-TNOc2	1790D-TNOV2
Go to low clamp	0 mA	0V DC
Go to high clamp	20 mA	10V DC
Go to fault/idle value	User configurable	User configurable
Hold last state	Hold last value	Hold last value

The user-specified value is entered in raw/proportional notation. For example:

- 0 is the low clamp. This value equals 0 mA or 0V DC.
- 4095 is the high clamp. This value equals 20 mA or 10V DC.
- Values from 0 to 4095 denote proportional values. 2048 equals 10 mA or 5V DC.

The values in the output data file are retained. Once a fault or idle condition is cleared, the retained output values are sent to the analog output channels.

Configure the Analog Output Module

RSNetWorx allows you to identify the network and configure the I/O modules with easy-to-use Electronic Data Sheets (EDS).

To download EDS files for use in configuration, go to rok.auto/pcdc.

EDS files for blocks with matching catalog numbers (for D-shell and removable terminal block versions) are the same. The website, or in RSNetWorx for DeviceNet, there may be only one catalog number that is listed for both versions.

When using third-party configuration software, load the EDS files into the software and follow the vendor's instructions.

Configure Analog Modules with RSNetWorx

To configure analog modules, follow these steps:

1. Open RSNetWorx for DeviceNet.
2. Add an analog output module (for example, 1790D-NOc2) to the network, as shown.

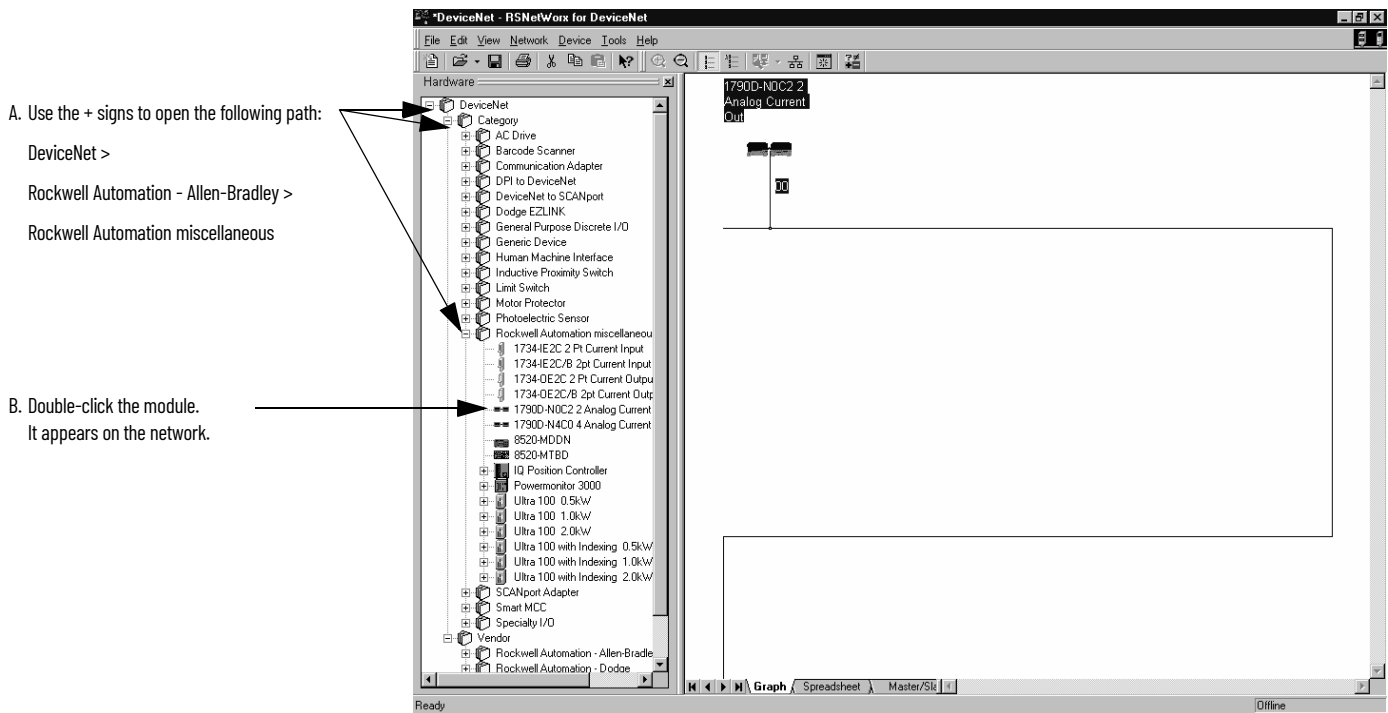

If your network is running, you can also click Browse to see what modules are on the network.

3. Double-click the module icon on the DeviceNet network. If you are online, upload the configuration and existing module parameters are shown. A dialog box similar to [Figure 18](#) displays.

Figure 18 - General Module Properties

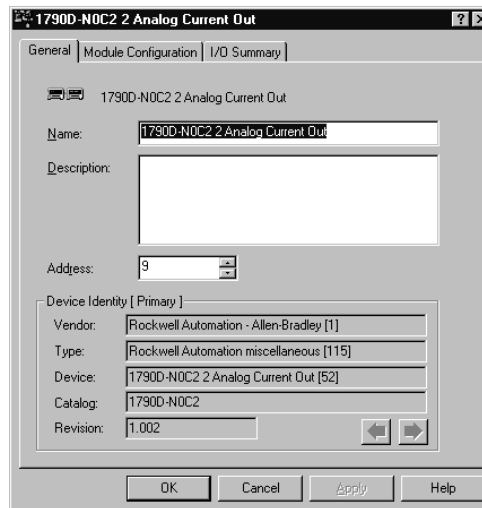

4. Click the Module Configuration tab. Analog input modules have a configuration dialog box similar to [Figure 19](#) for the 1790D-N0C2 module.

Figure 19 - Module Configuration

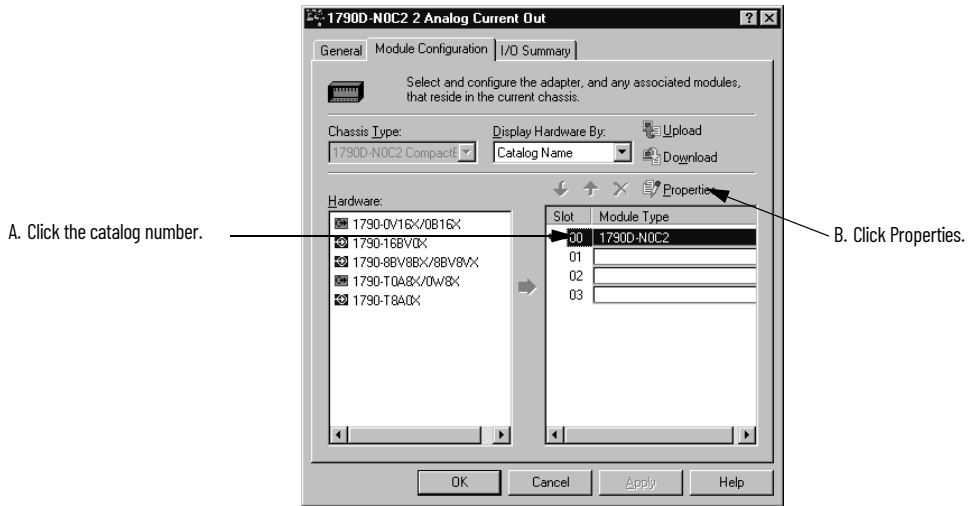

Use the Parameters tab to change module configuration. For example, [Figure 20](#) shows how to change the Autobaud selection.

Figure 20 - Parameters Tab

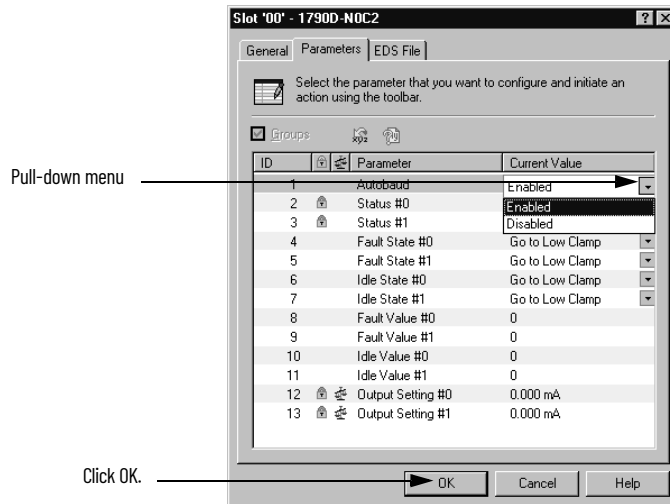

1. Use the pull-down menu to change range selection.
2. Click OK after making all configuration changes.

The screen returns to Module Configuration displays.

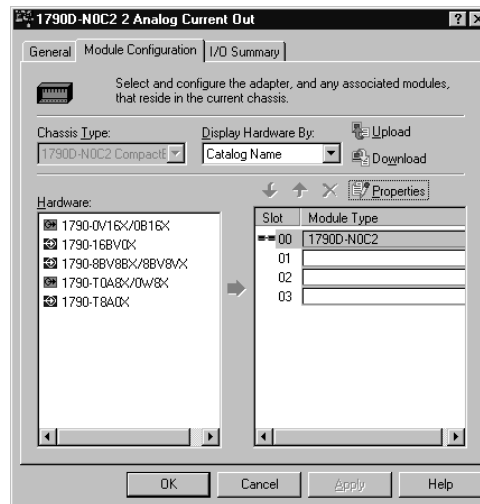

3. Click Download to save your configuration.
4. Click OK after making all configuration changes.

Notes:

Module Diagnostics and Troubleshooting

This chapter describes troubleshooting the analog input and output modules. This chapter contains information on:

- safety considerations when troubleshooting
- module vs. channel operation
- the module's diagnostic features

Safety Considerations

Safety considerations are an important element of proper troubleshooting procedures. Consider the safety of yourself and others, and the condition of your equipment, as a primary importance.

The following sections describe several safety concerns that you should be aware of when troubleshooting your control system.



ATTENTION: Never reach into a machine to actuate a switch because unexpected motion can occur and cause injury. Remove all electrical power at the main power disconnect switches before checking electrical connections or inputs/outputs causing machine motion.

Status Indicator Lights

When the green MOD and NET status indicator lights on the analog module are illuminated, it indicates that power is applied to the module, and the module is communicating on the network.

Activating Devices When Troubleshooting

When troubleshooting, never reach into the machine to actuate a device. Unexpected machine motion could occur.

Stand Clear of the Machine

When troubleshooting any system problem, have all personnel remain clear of the machine. The problem could be intermittent, and sudden unexpected machine motion could occur. Have someone ready to operate an emergency stop switch in case it becomes necessary to shut off power to the machine.

Program Alteration

There are several possible causes of alteration to the user program, including extreme environmental conditions, Electromagnetic Interference (EMI), improper grounding, improper wiring connections, and unauthorized tampering. If you suspect a program has been altered, check it against a previously saved program on an EEPROM or UV PROM memory module.

Safety Circuits

Always hard wire circuits installed on the machine for safety reasons, such as overtravel limit switches, stop push buttons, and interlocks, to the master control relay. You must wire these devices in series so that, when any one device opens, the master control relay is de-energized and removes power to the machine. Never alter these circuits to defeat their function. Serious injury or machine damage could result.

Module Operation vs. Channel Operation

The module performs operations at two levels:

- module level – power-up, configuration, and communication with a controller
- channel level – data conversion and over- or underrange detection

Internal diagnostics are performed at both levels of operation. When detected, module error conditions are indicated by the module status and individual channel status indicator lights.

Power-up Diagnostics

Module Status

At module power-up, a series of internal diagnostic tests is performed. These diagnostic tests must be successfully completed. [Table 32](#) shows module status indicator operation.

Table 32 - Module Status Indicator

Status Indicator	Status	Description
Module status	Steady red	Unrecoverable fault in base unit
	Flashing red	Recoverable fault
	Steady green	Normal operation
	Flashing green	Stand by
	Off	No power

Network Status

The network status indicator shows the condition of the DeviceNet connection. [Table 33](#) shows network status indicator operation.

Table 33 - Network Status Indicator

Status indicator	Status	Description
Network status	Steady red	Unrecoverable communication fault
	Flashing red	Recoverable communication fault
	Steady green	Communication path complete
	Flashing green	Communication path incomplete
	Off	Device is not online or not powered

Channel Diagnostics

When an input or output module channel is enabled, the module performs a diagnostic check to see that the channel has been properly configured. In addition, the module checks each channel on every scan for configuration errors, under range, open circuit (input module in 4...20 mA range only).

Out-of-Range Detection (Input Modules Only)

An out-of-range low test is performed on all channels that are configured for 4...20mA inputs. Whenever an out of range low condition occurs, the status bit for that channel is set in input data word 4.

Open-Circuit Detection (Input Module Only)

The module performs an open-circuit test on all channels that are configured for 4...20 mA inputs. Whenever an open circuit condition occurs, the status bit for that channel is set in input data word 4.

Possible causes of an open circuit include:

- the sensing device may be broken
- a wire may be loose or cut
- the sensing device may not be installed on the configured channel

Analog Input Module Error Definition Table

Analog input module errors are expressed on a channel basis in input read word 4. [Figure 34](#) shows the structure of the status data.

Table 34 - Input Channel Status Data

Word	Bit Position															
	15	14	13	12	11	10	9	8	7	6	5	4	3	2	1	0
4	Not used												S3	S2	S1	S0

Table 35 - Word/Bit Descriptions

Word	Decimal Bit	Description
Read Word 4	Bits 00...03	Status bits for individual channels – Bit 00 corresponds to input channel 0, bit 01 corresponds to input channel 1 and so on. When set (1) indicates: <ul style="list-style-type: none"> • No field power • Open wire – 4...20 mA current input only • Under range – 4...20 mA current input only • Recoverable module fault (whole channel to be set) • Unrecoverable module fault (whole channel to be set)
	Bits 04...15	Not used: Set to 0

Module Errors

[Table 36](#) lists possible errors that cause the analog input module status bits to be set.

Table 36 - Status Bit Table 1790D-N4C0/-TN4C0, 1790D-TN4V0

Range Setting	Underrange	In Range	Overrange	Open Circuit	Short Circuit	No Field Power
4...20 mA	<4 mA Set	Not set	>20 mA Not set	Set	Set	Set
0...20 mA	<0 mA Not set	Not set	>20 mA Not set	Not set	Not set	Set
0...10V DC	<0V DC Not set	Not set	>10V Not set	Not set	Not set	Set

Channel Status Indicator Operation

[Table 37](#) and [Table 38](#) show individual channel status indicator operation.

Table 37 - Analog Input Modules – 1790D-TN4C0

Status	Description
Flashing green/red	Power up
Off	Offline
Red	Online and no field power
Red	DeviceNet connection and no field power
Flashing red ⁽¹⁾	Field power and open wire – 4...20 mA range only⁽²⁾
Green	Field power and valid input
Green	Input over range
Flashing red ¹	Input under range <3 mA – 4...20 mA range only²
Flashing red	Recoverable fault

(1) Green for 0...20 mA range.

(2) Can be determined from the data table.

Table 38 - Analog Output Modules – 1790D-TNOV2, 1790D-TNOC2

Status	Description
Flashing green/red	Power up
Off	Off line
Off	On line and no field power
Green	DeviceNet connection and no field power
Green	Field power and open wire
Green	Field power and valid output
Flashing red	Field power and output out of range
Flashing green	Output idle
Flashing red	Recoverable fault

Contacting Rockwell Automation

If you must contact Rockwell Automation for assistance, have the following information available when you call:

- a clear statement of the problem, including a description of what the system is actually doing. Note the status indicator state; also note input and output image words for the module.
- a list of remedies you have already tried.
- processor type and firmware number. See the label on the processor.
- hardware types in the system, including all I/O modules
- fault code if the processor is faulted.

Notes:

Install, Wire, and Configure PROFIBUS Modules

This appendix tells you how to:

- determine the power requirements for the PROFIBUS modules
- avoid electrostatic damage
- install the module
- view the module memory map
- access the input image file
- configure channels

Power Requirements

Modules require external supplies for both system power and for the analog I/O channels. [Table 39](#) lists the maximum power.

Table 39 - Analog I/O Channel Power

PROFIBUS power	Supply voltage - 24V DC nom Voltage range - 19.2...28.8V DC Power dissipation - 2 W max @ 28.8V DC
Field power	Supply voltage - 24V DC nom Voltage range - 21.6...26.4V DC (± 10%) Power dissipation - 1.5 W max @ 26.4V DC

Module Installation

CompactBlock LDX I/O modules are suitable for use in a commercial or light industrial environment when installed in accordance with these instructions. Specifically, this equipment is intended for use in clean, dry environments (Pollution degree 2⁽¹⁾) and to circuits not exceeding overvoltage Category II⁽²⁾ (IEC 60664-1)⁽³⁾.

General Considerations

Reducing Noise

Most applications require installation in an industrial enclosure to reduce the effects of electrical interference. Analog inputs and outputs are highly susceptible to electrical noise. Electrical noise coupled to the analog inputs reduces the performance (accuracy) of the module.

- (1) Pollution Degree 2 is an environment where, normally, only non-conductive pollution occurs except that occasionally a temporary conductivity caused by condensation shall be expected.
- (2) Over Voltage Category II is the load level section of the electrical distribution system. At this level, transient voltages are controlled and do not exceed the impulse voltage capability of the product's insulation.
- (3) Pollution Degree 2 and Over Voltage Category II are International Electrotechnical Commission (IEC) designations.

Group your modules in the enclosure to minimize adverse effects from radiated electrical noise and heat. Consider the following conditions when selecting a location for the analog module. Position the module:

- away from sources of electrical noise such as hard-contact switches, relays, and AC motor drives
- away from modules that generate significant radiated heat.

In addition, route shielded, twisted-pair analog input and output wiring away from any high-voltage I/O wiring.

Protect the Circuit Board from Contamination

The printed circuit boards of the analog modules must be protected from dirt, oil, moisture, and other airborne contaminants. To protect these boards, the system must be installed in an enclosure suitable for the environment. The interior of the enclosure should be kept clean and the enclosure door should be kept closed whenever possible.

Install the CompactBlock LDX I/O Block

Follow these steps to install the block:

1. [Set the Station Address on the Base Block](#)
2. [Mount the Base Block](#)
3. [Connect the PROFIBUS DP Terminal Connector](#)
4. [Connect Power to the Block](#)

Set the Station Address on the Base Block

To set the station address, adjust the switches on the front of the base block. The two switches are most significant digit (MSD) and least significant digit (LSD). The switches can be set from 00 to 99 and are read at base block power-up only. [Figure 21](#) shows an example base block set for station address 11.

Figure 21 - Node Address Settings

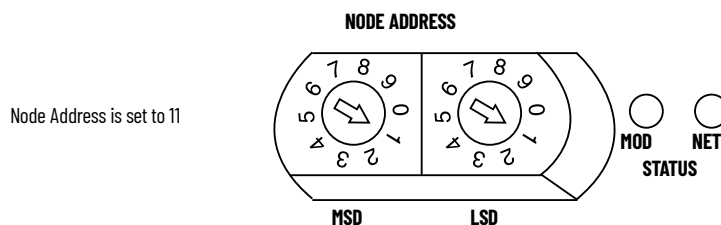

Mount the Base Block

You can mount the base block to a panel or DIN rail. We recommend that you ground the panel or DIN rail before mounting the block.

IMPORTANT The analog base module can accommodate a **maximum** of two discrete expansion modules.



WARNING: When used in a Class I, Division 2, hazardous location, this equipment must be mounted in a suitable enclosure with proper wiring method that complies with the governing electrical codes.

Panel Mounting

1. Place the block against the panel where you want to mount it.
2. Gently pull and position the expansion cover to the left.
3. Place a center punch, nail, or similar device through the mounting holes in the block and make two marks on the panel (lower left and upper right corners of the module).
4. Remove the block and drill two holes in the panel to accommodate each of the mounting screws.
5. Replace the block on the panel and place a screw through each of the two mounting holes. Tighten the screws until the block is firmly in place.

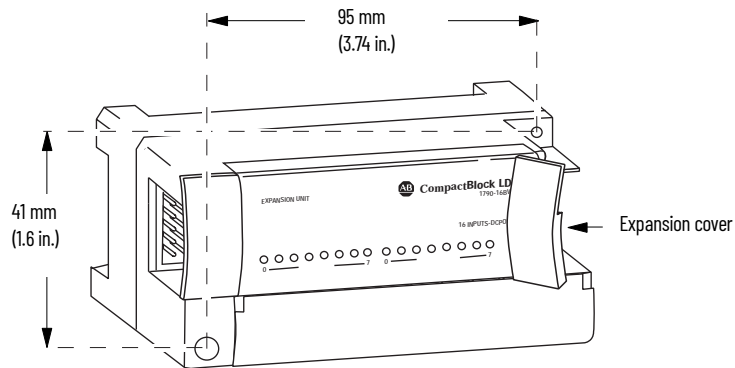

DIN Rail Mounting

1. Hook the top of slot of the block over the DIN Rail.
2. Pull down on the locking lever while pressing the block against the rail.

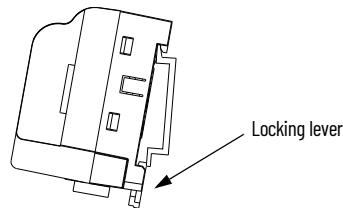

3. Push up on the locking lever to secure the block to the rail when block is flush against the rail.

Mount the Optional Expansion Blocks

Mount the expansion block by connecting it to a previously installed CompactBlock LDX I/O base or expansion block.

Beginning with the base block, you can mount your expansion blocks either horizontally or vertically:

- horizontally (left to right) – add expansion blocks in an end-to-end configuration
- vertically (up or down) – add expansion blocks either up or down in a back-to-back configuration. In this configuration, you must use the optional 15 cm (5.90 in.) ribbon cable (1790-15CMCBL) and alternately position the blocks in a right-side up, upside-down fashion.

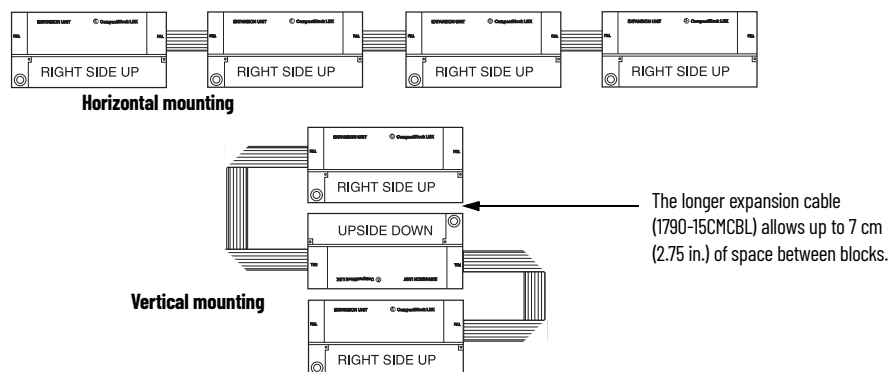

You can mount your blocks on a panel or DIN rail as described in the previous section.

Connect the PROFIBUS DP Terminal Connector

Follow these procedures when connecting the PROFIBUS DP terminal connector to the base block.



WARNING: If you connect or disconnect the PROFIBUS cable with power applied to this module or any device on the network, an electrical arc can occur. This could cause an explosion in hazardous location installations. Be sure that power is removed or the area is nonhazardous before proceeding.

The required PROFIBUS female 9-pin D-sub connector is not supplied with the base block; you must purchase it separately. Before you connect the female 9-pin D-sub connector to the base block, make sure it is wired correctly, as shown in [Table 40](#).

Table 40 - Wiring Connections

Pin Number	Name	Description
1	Shield	Shield, protective ground
2	M24V	Minus 24V output voltage
3	RxD/TxD-P	Receive/transmit-data-P
4	CNTR-P	Control-p
5	DGND	Data ground
6	VP	Voltage-plus
7	P24V	Plus 24V output voltage
8	RxD/TxD-N	Receive/transmit-data-N
9	CNTR-N	Control-N

Once you have properly wired the connector, attach it to the base block as shown in [Figure 22](#). Use the locking screws on the connector to fasten it to the base block.

Figure 22 - PROFIBUS Connector Wiring

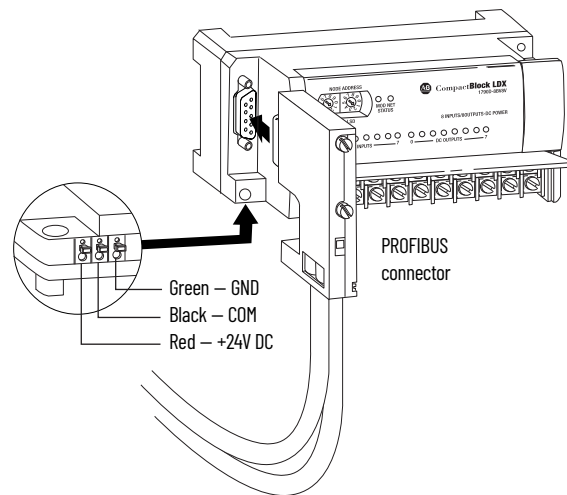

Connect Power to the Block

To apply power to the block, see [Figure 22](#).

Connect I/O Wiring

Consider the following guidelines when wiring your system:

General Guidelines

- All module commons (ANLG COM) are connected in the analog module. The analog common (ANLG COM) is not connected to earth ground inside the module.
- Channels are not isolated from each other.
- Do not use the analog module's NC terminals as connection points.
- To ensure optimum accuracy, limit overall cable impedance by keeping your cable as short as possible. Locate the I/O system as close to your sensors or actuators as your application permits.
- Use Belden 8761, or equivalent, shielded wire.
- Keep shield connection to ground as short as possible.
- Under normal conditions, the drain wire and shield junction must be connected to earth ground via a panel or DIN rail mounting screw at the analog I/O module end.

Guidelines for Input Modules

- If multiple power supplies are used with analog inputs, the power supply commons must be connected together.
- The module does not provide loop power for analog inputs. Use a power supply that matches the input transmitter specifications.

Guidelines for Output Modules

- Current outputs (CH0 and CH1) of the 1790P-TNOC2 module source current that returns to COM. Load resistance for a current output channel must remain 0...600 Ω .

Wiring the Modules



ATTENTION: To prevent shock hazard, care should be taken when wiring the module to analog signal sources. Before wiring any analog module, disconnect power from the system power supply and from any other source to the analog module.

After the analog module is properly installed, follow the wiring procedure. To ensure proper operation and high immunity to electrical noise, always use Belden 8761 (shielded, twisted-pair) or equivalent wire.



ATTENTION: Never connect a voltage or current source to an analog output channel.

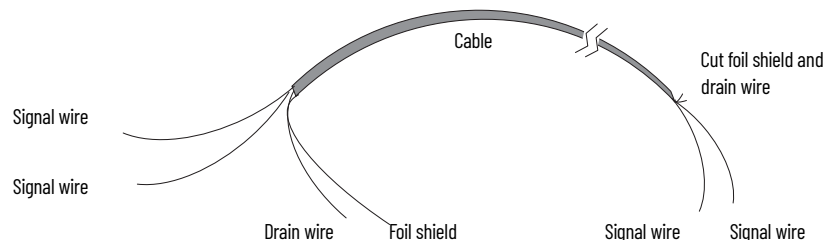

To wire your module, follow these steps.

1. At each end of the cable, strip some casing to expose the individual wires.
2. Trim the signal wires to 5 cm (2 in.) lengths. Strip about 5 mm (3/16 in.) of insulation away to expose the end of the wire.



ATTENTION: Be careful when stripping wires. Wire fragments that fall into a module could cause damage at power-up.

3. At one end of the cable, twist the drain wire and foil shield together.

Under normal conditions, this drain wire and shield junction must be connected to earth ground, via a panel or DIN rail mounting screw at the analog I/O module end. Keep the length of the drain wire as short as possible.

In environments where high frequency noise is present, ground the cable shields to earth at the module and via a 0.1 μF capacitor at the sensor end for analog inputs and at the load end for analog outputs.

4. At the other end of the cable, cut the drain wire and foil shield back to the cable.
5. Connect the signal wires to the terminal block as shown in [Analog Input Wiring](#) on page 52 and [Analog Output Wiring](#) on page 53.
6. Connect the other end of the cable to the analog input or output device.
7. Repeat steps 1...5 for each channel on the module.

Analog Input Wiring

Use the information in [Table 41](#) and [Figure 23](#) to wire the 1790P-TN4Co terminal block module.

Table 41 - 1790P-TN4CO Input Wiring

Pin Number	1	3	5	7	9	11	13	15	17	19
Description	+24V ⁽¹⁾	CHO	CH1	CH2	CH3	NC	NC	NC	NC	NC
Pin Number	2	4	6	8	10	12	14	16	18	20
Description	GND ⁽²⁾	COM	COM	COM	COM	NC	NC	NC	NC	NC

- (1) +24V: Field power (+) 24V DC
- (2) GND: Field power (-) Ground

Figure 23 - 1790P-TN4CO Input Wiring Diagram

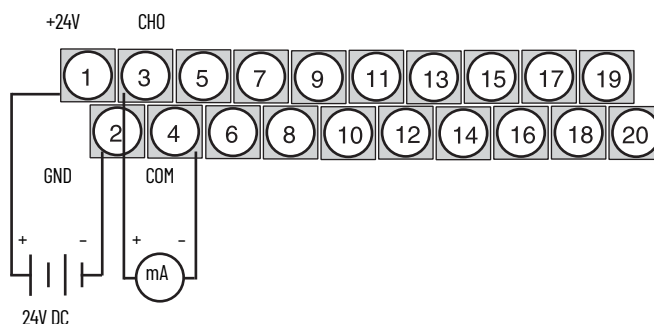

Analog Output Wiring

Use the information in [Table 42](#) and [Figure 24](#) to wire the 1790P-TN0C2 terminal block modules.

Table 42 - 1790P-TN0C2 Output Wiring

Pin Number	1	3	5	7	9	11	13	15	17	19
Description	+24V ⁽¹⁾	CHO	CH1	NC	NC	NC	NC	NC	NC	NC
Pin Number	2	4	6	8	10	12	14	16	18	20
Description	GND ⁽²⁾	COM	COM	NC	NC	NC	NC	NC	NC	NC

- (1) +24V: Field power (+) 24V DC
- (2) GND: Field power (-) Ground

Figure 24 - 1790P-TN4CO Output Wiring Diagram

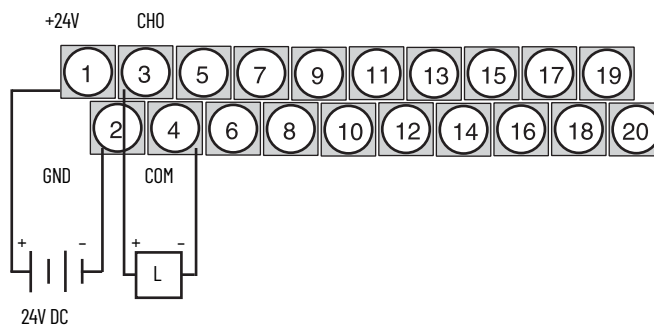

1790P-TN4CO Data Structure Analog Input Image

The input image file represents data words and status bits. Input words 0...3 hold the input data that represents the value of the analog inputs for channels 0...3. These data words are valid only when the channel is enabled and there are no errors. Input word 4 holds the status bits. Analog input data is presented as raw/proportional.

Input words 5 and 6 contain input data for two optional discrete input expansion modules.

1790P-N4CO/TN4CO Configuration

Each analog current input is configured for either the 4...20 mA or 0...20 mA range by using the programming software compatible with the controller or scanner. See [Configure Analog Modules with SST PROFIBUS Configuration Tool on page 55](#) for an example of configuration using the SST PROFIBUS Configuration Tool.

Analog input data is presented as raw/proportional. The full 12-bit resolution is used over the entire span of the input full scale range, as shown in [Table 43](#).

Table 43 - Module Bit Resolution

Input Full Scale Range	HEX Data Range	Decimal Data Range	Input Resolution
4...20 mA	0000...0FFF	0...4095	3.90 μ A
0...20 mA	0000...0FFF	0...4095	4.88 μ A

The input data files are the same as those shown for the 1790D-TN4CO. See [Analog Input Data File on page 25](#) for more information.

1790P-TNOC2 Data Structure Analog Output Image

The output image file represents data words. Output words 0 and 1 hold the output data that represents the value of the analog outputs for channels 0 and 1. Analog output data is presented as raw/proportional.

Output words 2 and 3 contain output data for two optional discrete output expansion modules.

Analog output data is presented as raw/proportional. The full 12-bit resolution is over the entire span of the output full scale range, as shown in [Table 44](#).

Table 44 - Module Bit Resolution

Output Full Scale Range	HEX Data Range	Decimal Data Range	Input Resolution
0...20 mA	0000...0FFF	0...4095	4.88 μ A

The output data files are the same as those shown for the 1790D-TNOC2. See [Install, Wire, and Configure PROFIBUS Modules on page 47](#) for more information.

Output Fault and Idle States

For PROFIBUS modules, analog outputs reset to zero under fault (communication failure) and idle (processor in program mode) states. The values in the output data file are retained. Once a fault or idle condition is cleared, the retained output values are sent to the analog output channels.

Configuring PROFIBUS Analog Modules

You can use the PROFIBUS configuration software (with easy-to-use GSD files) to configure the CompactBlock LDX I/O analog modules (1790P-TN4CO and 1790P-TNOC2).

Download firmware, associated files (such as AOP, EDS, and DTM), and access product release notes from the Product Compatibility and Download Center at rok.auto/pcdc.

To read how to install the GSD file for your module, use the SST PROFIBUS configuration tool documentation such as online help. The next section shows how to configure your analog module with the SST PROFIBUS configuration tool.

Configure Analog Modules with SST PROFIBUS Configuration Tool

The following configuration example shows how to configure your analog modules with the SST PROFIBUS configuration tool. Follow these steps:

1. Open your SST PROFIBUS configuration tool. If you are online, make sure that the processor is in Program mode.
2. Add the PROFIBUS master to your network.

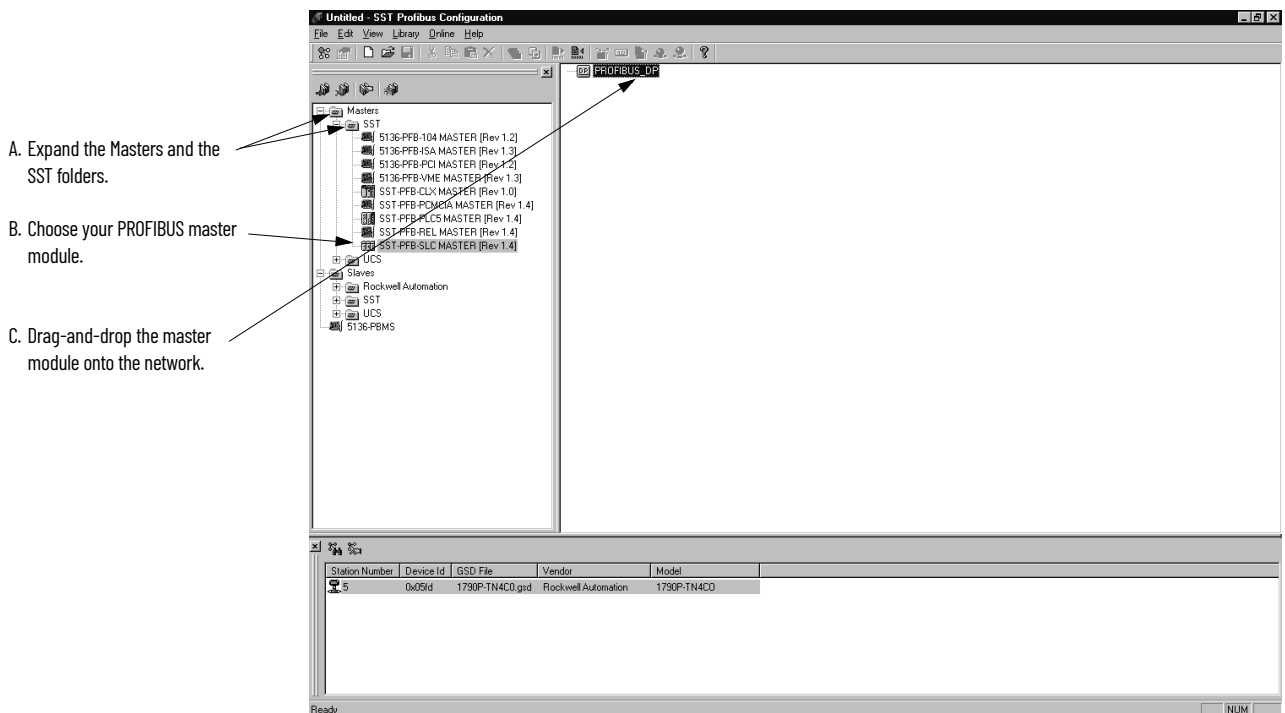

3. To see the device properties popup screens, double-click the master icon. The first screen is the General properties.

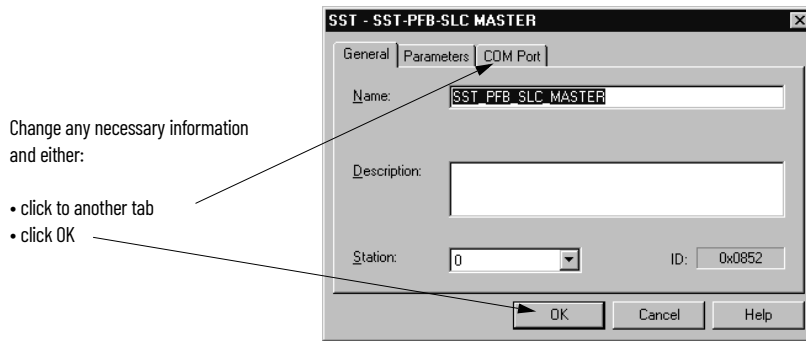

Change any necessary information and either:

- click to another tab
- click OK

4. Add slaves to the network.

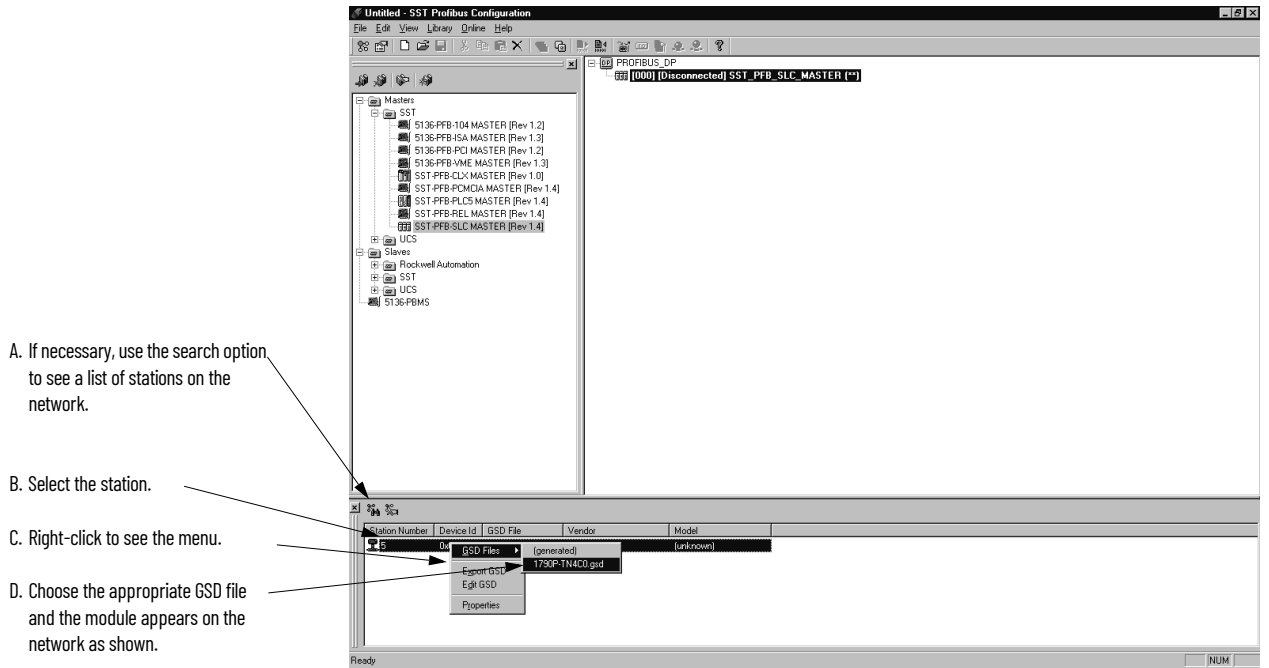

A. If necessary, use the search option to see a list of stations on the network.

B. Select the station.

C. Right-click to see the menu.

D. Choose the appropriate GSD file and the module appears on the network as shown.

5. Access the module properties.

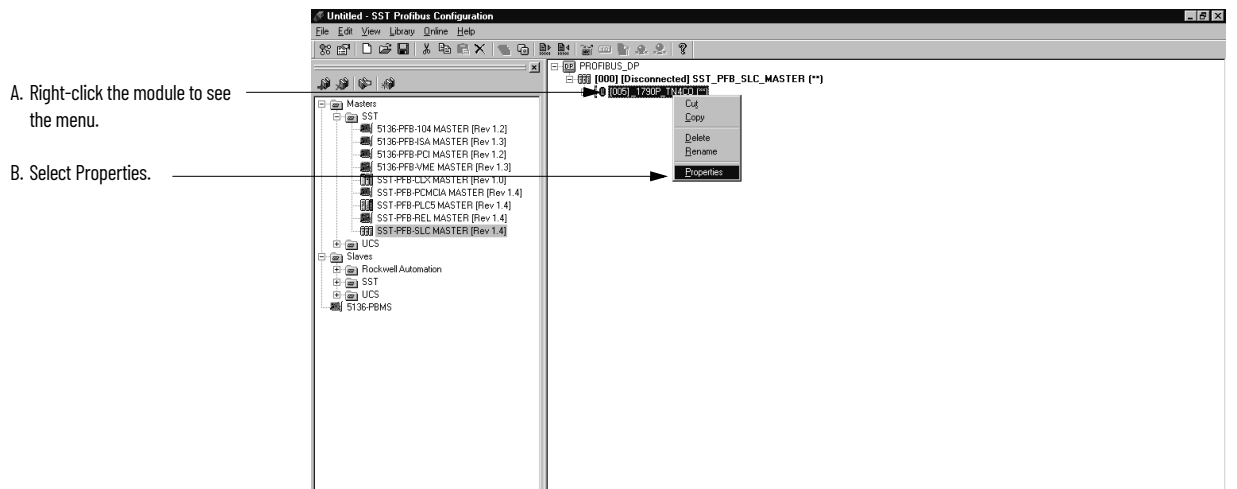

A. Right-click the module to see the menu.

B. Select Properties.

6. To change the module properties, use the General tab on the Module Properties dialog as shown in [Figure 25](#).

Figure 25 - General Module Properties

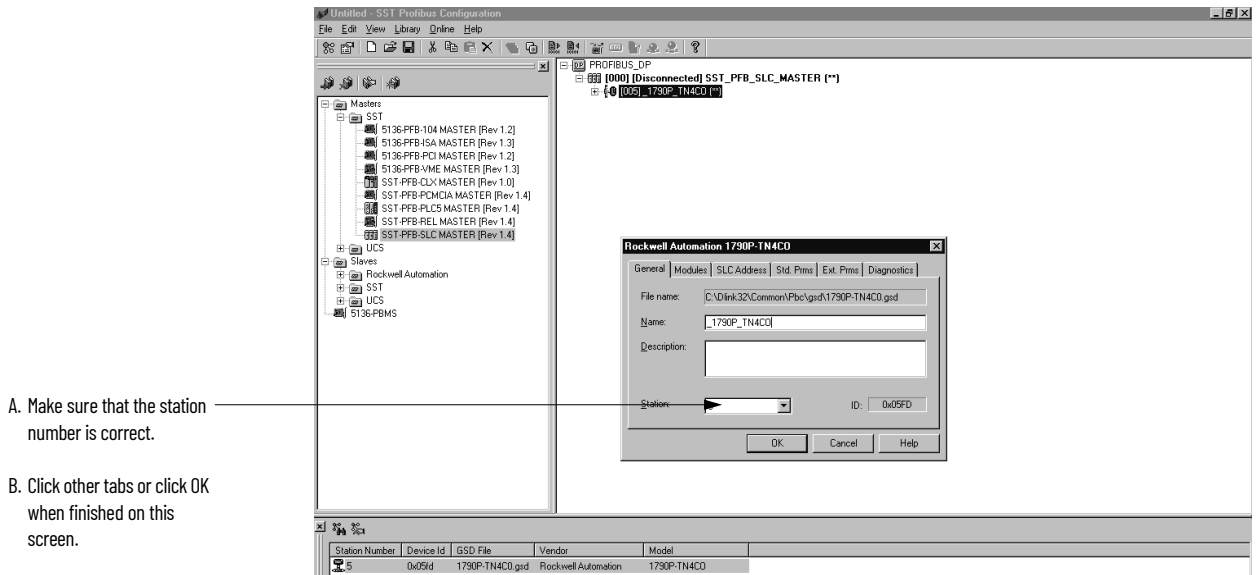

- A. Make sure that the station number is correct.
- B. Click other tabs or click OK when finished on this screen.

7. If necessary, add additional modules as shown.

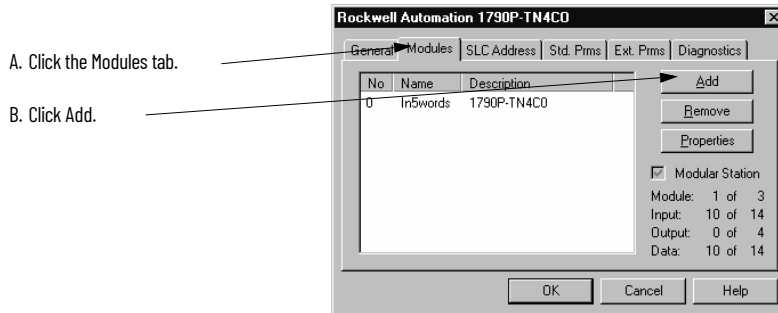

- A. Click the Modules tab.
- B. Click Add.

The following screen appears to add modules.

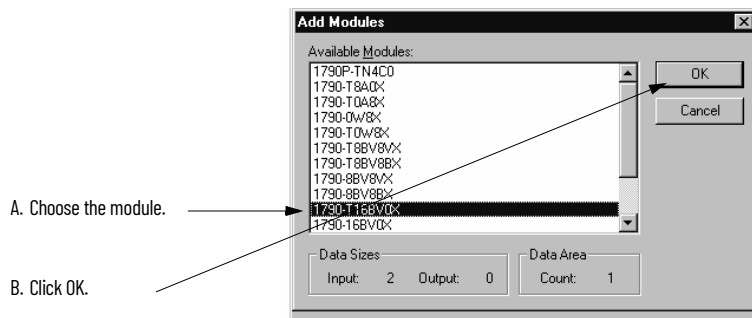

- A. Choose the module.
- B. Click OK.

Up to two expansion modules may be added to analog base modules.

8. Set the I/O type. This screen also shows the data size information.

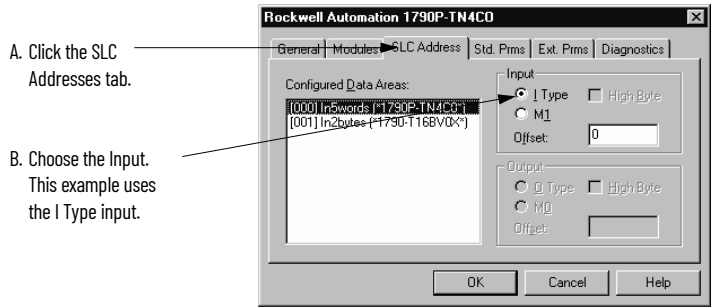

9. Set the Watchdog Time Base and Current Range.

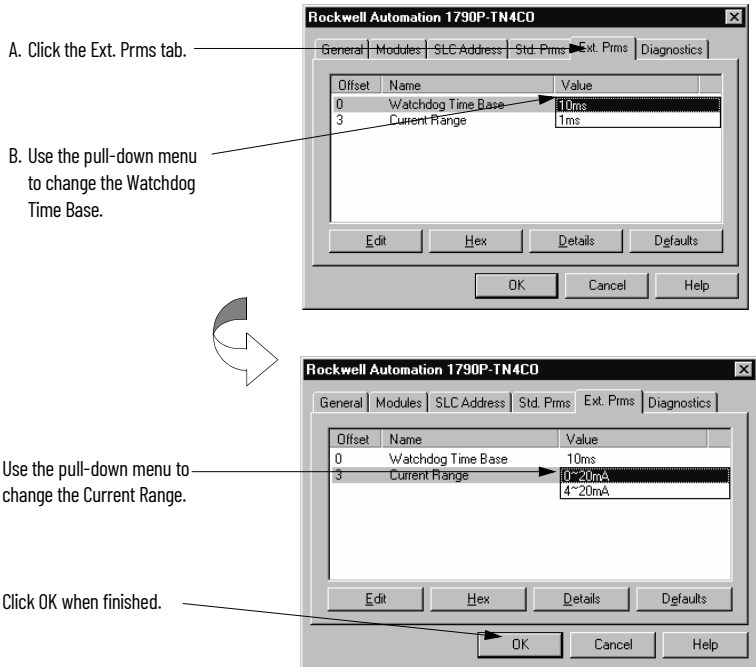

10. Save the configuration file.

Download the Configuration

To download the configuration to the module, follow these steps:

1. Make sure that the serial communication cable is connected between the PC com port and the scanner serial port.
2. Verify that the processor is in Program mode.
3. Use the SST PROFIBUS configuration tool to connect to the master.

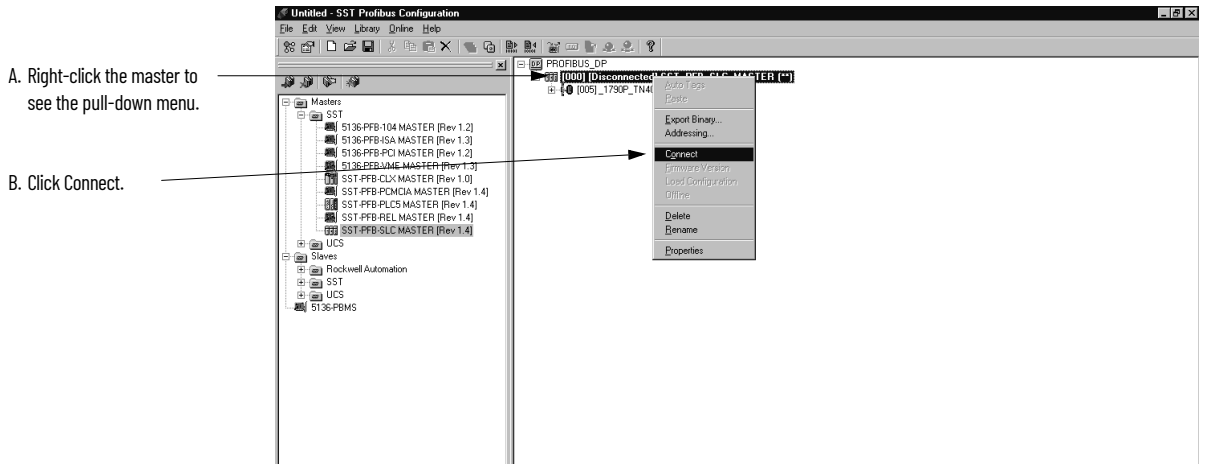

- You may be notified about a configuration mismatch between what is in the scanner and your current PROFIBUS project. Choose YES to retain your configuration.

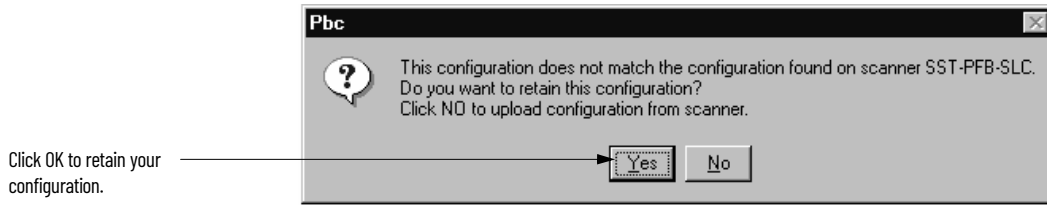

Any configuration mismatches are displayed in the software, as shown.

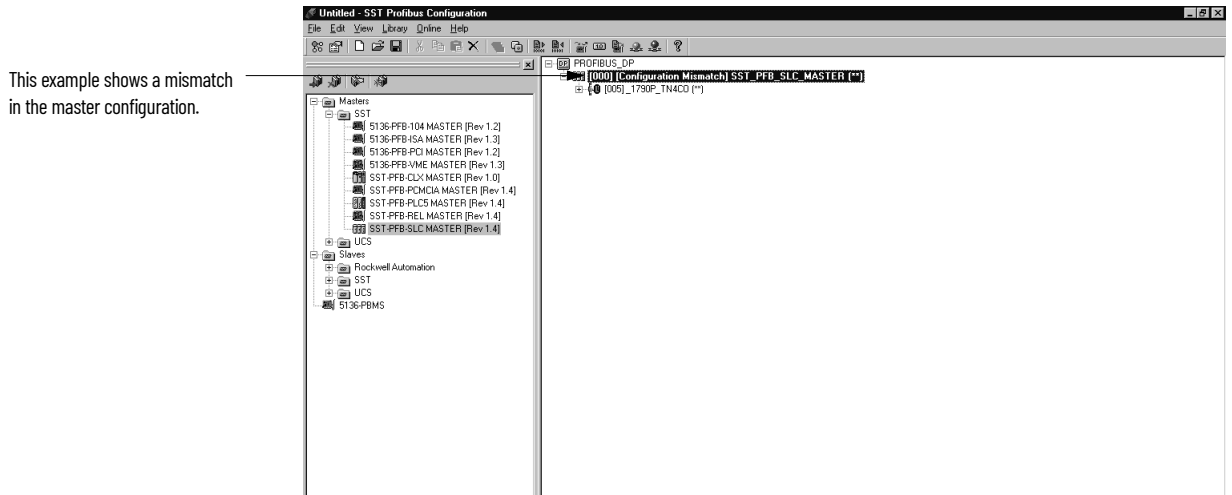

- Load configuration to the master.

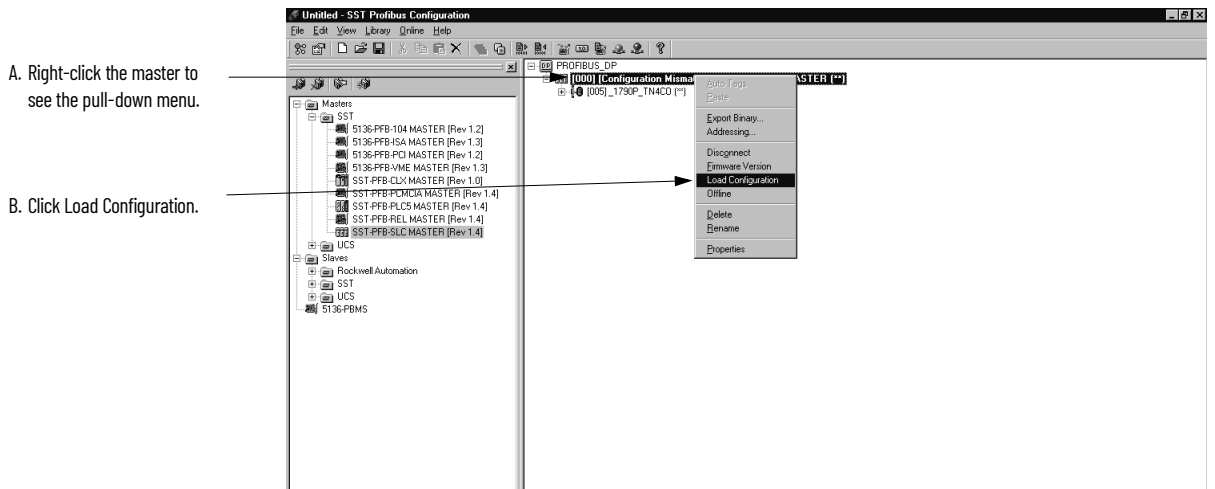

- If the scanner is online, the software prompts you to load the configuration. Choose YES.

The master status changes to the Configured Program mode.

This master is in Configured Program mode.

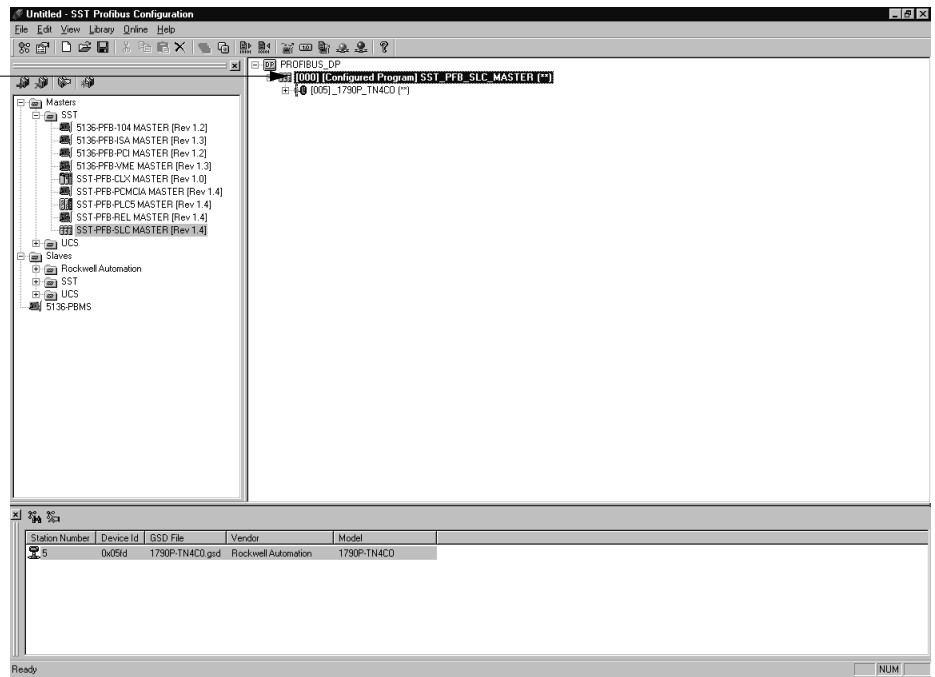

7. Change the processor to Run mode. In addition to steady green indicator lights on the module, you should see the dialog box shown.

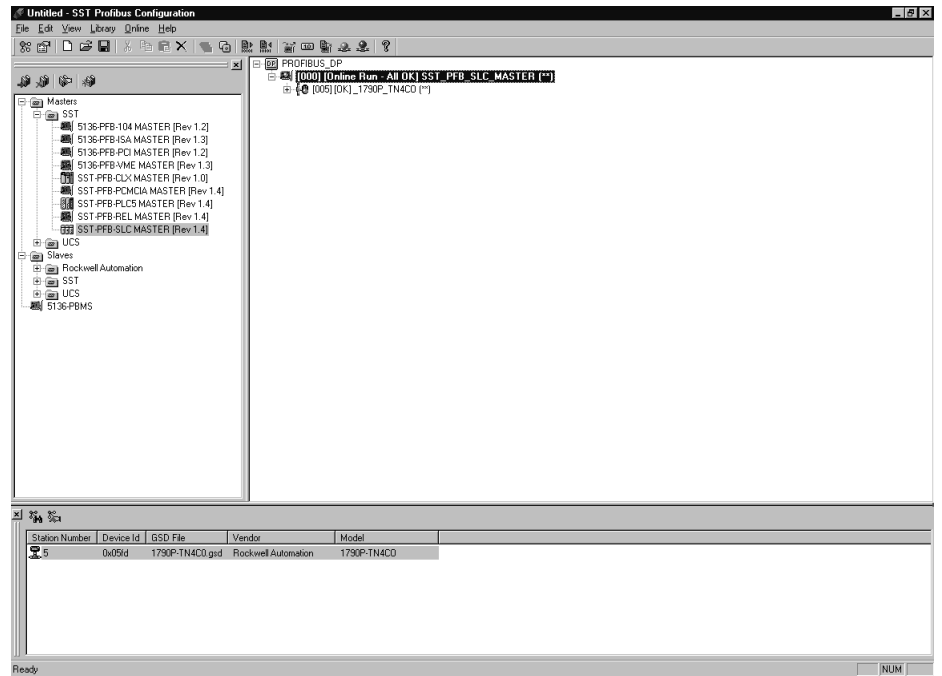

A

analog input module

overview 9

C

channel diagnostics 43

channel status LED 11

contacting Rockwell Automation 45

current draw

1769-IF4 13

1769-OF2 13

E

electrical noise 13

F

fault condition

at power-up 11

H

heat considerations 13

I

installation 13 - 16

heat and noise considerations 13

O

open-circuit detection 43

operation

system 11

out-of-range detection 43

P

power-up diagnostics 42

power-up sequence 11

program alteration 42

S

safety circuits 42

system operation 11

T

troubleshooting

safety considerations 41

W

wiring 13

input module 21

input terminal layout 21, 22, 23

modules 20

output module 21, 23

routing considerations 13

Notes:

Rockwell Automation Support

Use these resources to access support information.

Technical Support Center	Find help with how-to videos, FAQs, chat, user forums, and product notification updates.	rok.auto/support
Knowledgebase	Access Knowledgebase articles.	rok.auto/knowledgebase
Local Technical Support Phone Numbers	Locate the telephone number for your country.	rok.auto/phonesupport
Literature Library	Find installation instructions, manuals, brochures, and technical data publications.	rok.auto/literature
Product Compatibility and Download Center (PCDC)	Download firmware, associated files (such as AOP, EDS, and DTM), and access product release notes.	rok.auto/pcdc

Documentation Feedback

Your comments help us serve your documentation needs better. If you have any suggestions on how to improve our content, complete the form at rok.auto/docfeedback.

Waste Electrical and Electronic Equipment (WEEE)



At the end of life, this equipment should be collected separately from any unsorted municipal waste.





Rockwell Automation maintains current product environmental information on its website at rok.auto/pec.

Allen-Bradley, CompactBlock, expanding human possibility, FactoryTalk, Rockwell Automation, RSNetWorx, SLC, and TechConnect are trademarks of Rockwell Automation, Inc.

DeviceNet is a trademarks of ODVA, Inc.

Trademarks not belonging to Rockwell Automation are property of their respective companies.

Rockwell Otomasyon Ticaret A.Ş. Kar Plaza İş Merkezi E Blok Kat:6 34752, İçerenköy, İstanbul, Tel: +90 (216) 5698400 EEE Yönetmeliğine Uygundur

Connect with us.    

rockwellautomation.com ————— **expanding human possibility™**

AMERICAS: Rockwell Automation, 1201 South Second Street, Milwaukee, WI 53204-2496 USA, Tel: (1) 414.382.2000, Fax: (1) 414.382.4444

EUROPE/MIDDLE EAST/AFRICA: Rockwell Automation NV, Pegasus Park, De Kleetlaan 12a, 1831 Diegem, Belgium, Tel: (32) 2 663 0600, Fax: (32) 2 663 0640

ASIA PACIFIC: Rockwell Automation, Level 14, Core F, Cyberport 3, 100 Cyberport Road, Hong Kong, Tel: (852) 2887 4788, Fax: (852) 2508 1846