



Mark^{*}VleS Functional Safety System

Technical Specifications

ge.com/power



Mark* VleS Functional Safety System	3
Contact Input Module	8
Relay Contact Output Module	10
Vibration Input Module	13
Universal Analog I/O Module	15
Analog I/O Module	17
UCSC Controller	19
Modbus Master Communication Module	21
Industrial Ethernet / IONet Switches.	23
Power Distribution Module	25
Codes, Standards and Environment	28
Software Tools.	29
Example Burner Management System	30

The Mark* VleS Functional Safety System reflects GE's experience of three-plus decades, four generations, and over 10,000 installed Triple Modular Redundant (TMR) systems.

The Mark VleS is certified to IEC 61508 standards to meet the needs of the majority of safety requirements – SIL 2 and SIL 3.

In today's world of brilliant machines, operators require high-performance automation solutions that seamlessly connect their machines, data, and people while ensuring the safety and integrity of their process and equipment.

The Mark VleS Functional Safety System is born from a decades-long heritage of turbine protection and control. The Mark VleS system is a cost-effective, complete, flexible, and reliable functional safety system with enhanced cyber security for critical processes such as plant emergency shutdown, burner management, critical process control, and fire and gas detection applications.



A proven and safe solution

GE brings decades of domain expertise to the Mark VleS Functional Safety System. The Mark series of controllers has earned a reputation for superior running reliability and superior tripping reliability when required in thousands of TMR systems installed in power generation and infrastructure applications globally. These proven philosophies are at the heart of the Mark VleS Functional Safety System.

Flexibility and reliability

Redundancy is a critical feature in safety control system design, enabling continuous process operation during system maintenance or repair. The Ethernet backbone of the Mark VleS Functional Safety System allows each segment of the system to be configured with different levels of redundancy as follows:

- Can be: Simplex, Dual, or TMR
- I/O network (IONet) communications can be: Simplex, Dual, or TMR
- I/O modules can be: Simplex or TMR

This flexibility enables customers to design their system to meet the exact needs of their SIL application requirements, and ultimately reducing system costs. Customers can customize the level of redundancy to meet safety and running reliability needs.

Enhanced productivity and efficiency

Sophisticated application automation tools and seamless data integration between the control system and Human-machine Interface (HMI) enable process efficiencies during project execution to reduce delivered cost and improve quality. Enhanced software reusability features allow users to create and maintain logic standards that can then be efficiently deployed over and over again. This reduces project costs, increases the integrity of software, and reduces the risk of human error. All of these are critical considerations when deploying safety-related systems.

Seamless integration with basic process control system

GE understands the importance of seamless integration between your safety and existing control solutions. The Mark VleS control system offers flexibility, scalability, and standards-based operational interfaces to securely integrate with your existing process control systems. This integration allows world-class safety functionality to securely connect to existing processes, and create a seamless safety program.

Mark VleS Triple Modular Redundant (TMR) Control Modes

TMR 2oo3[†] SIL 3 high/low demand for de-energize-to-trip
 TMR 2oo3 SIL 2 low demand for energize-to-trip

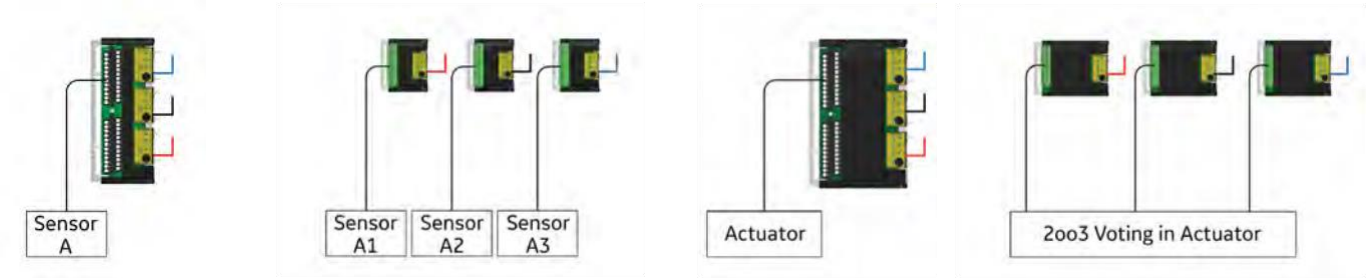
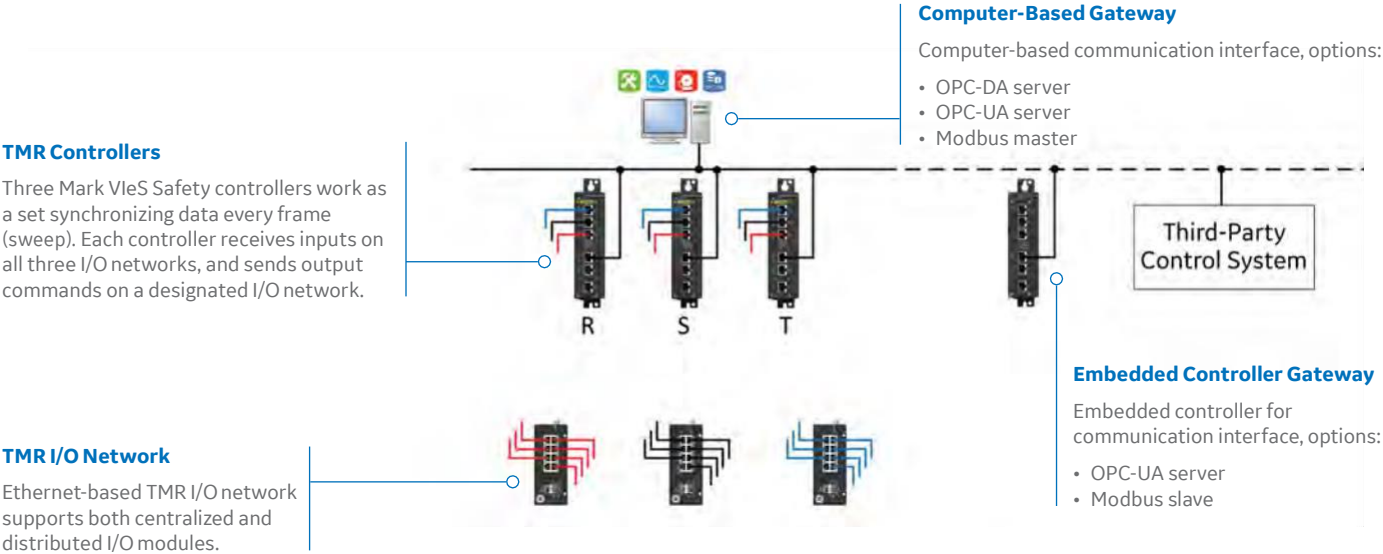

TMR Fanned Input

Single discrete/analog sensor is fanned through a common terminal board to three independent input packs, 2oo3 voting is done in the controller set.

TMR Dedicated Input

Three redundant discrete/analog sensors are wired to three independent input modules, 2oo3 voting is done in the controller set.

TMR Outputs Voted on Terminal Board

The three I/O packs receive output commands from their associated controller. The common terminal board then performs 2oo3 voting on the outputs and controls the discrete actuator.

TMR Outputs Voted in Actuator

Three independent output modules receive the output command from their associated controller, then command the actuator, 2oo3 voting is done in the actuator.

TMR Notes

- Degradation sequence: [2oo3] > [1oo2] > [Fail Safe]
- † 2oo3 is 2-out-of-3

Mark VleS Dual Control Modes

Dual 1oo2[†] SIL 3 high/low demand for de-energize-to-trip
 Dual 2oo2 SIL 2 low demand for energize and de-energize-to-trip

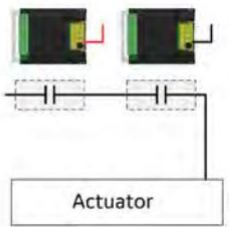
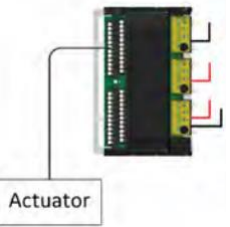
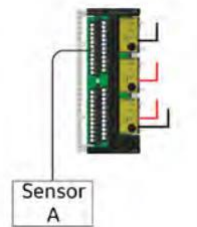
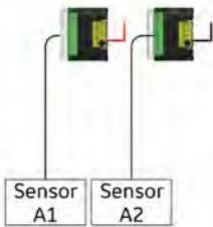
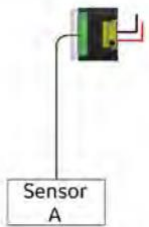
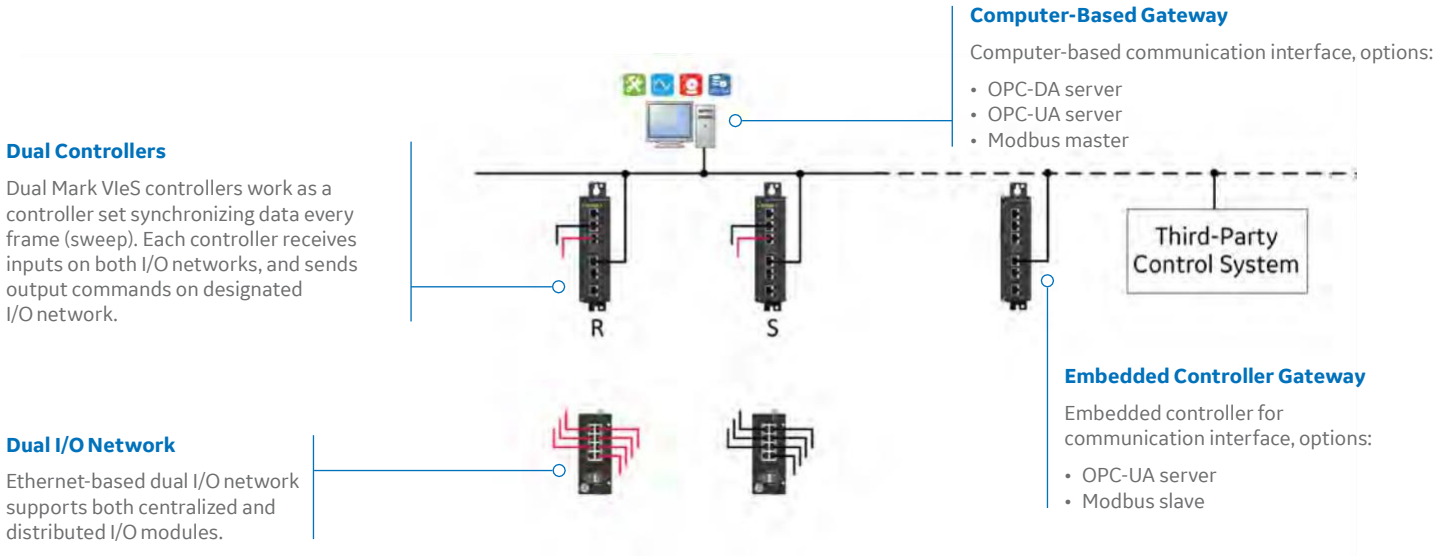

Single Sensor

Single sensor wired to a single input module with dual I/O network to controller set.

Dual Sensor

Dual sensors wired to independent input modules with independent I/O networks to controller set.

TMR Fanned Input

Single sensor is fanned through a common terminal board to three independent input packs, 2oo3 voting done in the controller set.

TMR Outputs Voted on Terminal Board

The three output packs receive an output command from the designated controller. The common terminal board then performs 2oo3 voting and controls the actuator.

1oo2 De-energize to Trip in Output Modules

Two independent output modules receive the output command from the designated controller. The combination of the two creates a 1oo2 de-energize to trip function across the two modules.

Dual Notes

[†] 1oo2 is 1-out-of-2; 2oo2 is 2-out-of-2

Simplex Control Mode

Simplex 1oo1[†] SIL 2 low demand for de-energize to trip

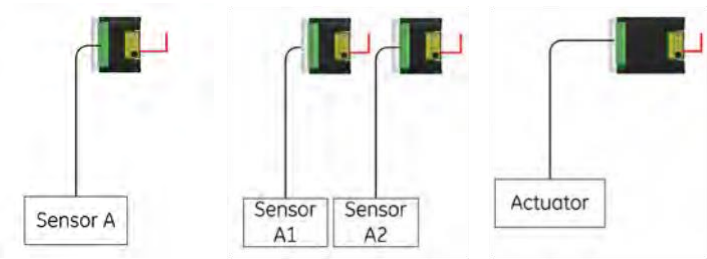
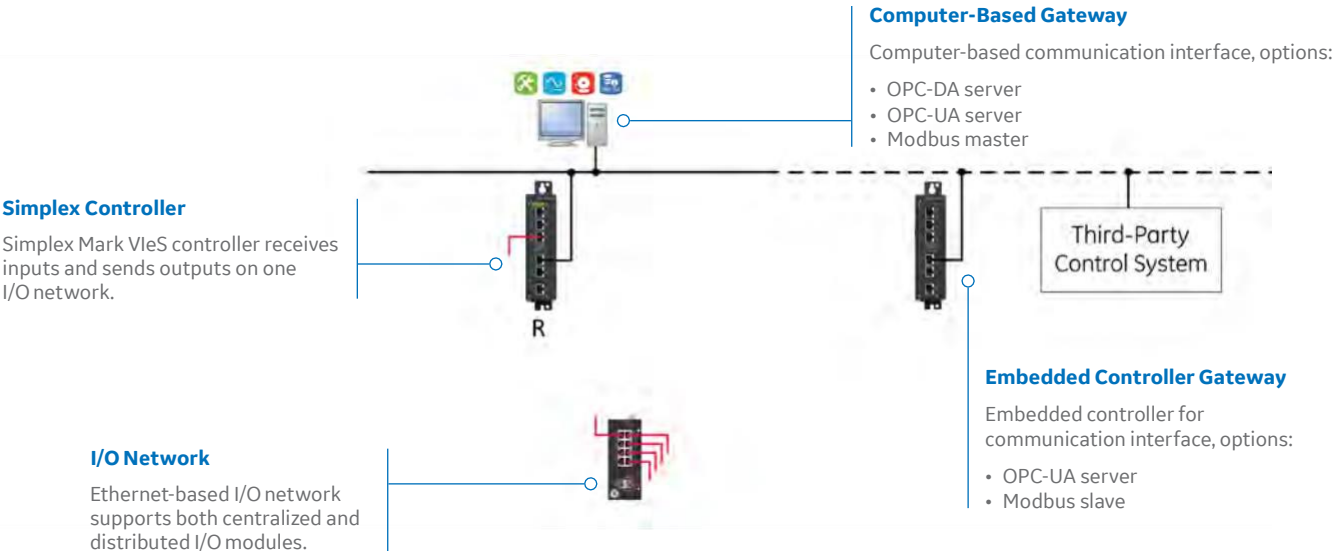

Single Sensor

Single sensor wired to a single input module with a simplex I/O network to the controller.

Dual Sensor

Dual sensors wired to independent input modules with a simplex I/O network to the controller.

Simplex Output

One output pack receives an output command from the controller.

Simplex Notes

[†] 1oo1 is 1-out-of-1



Contact Input Module

The Mark* VleS Functional Safety Contact Input module provides an interface between discrete contact process sensors (24 discrete inputs) and Mark VleS Safety control logic. The Contact Input module consists of two orderable parts: the contact input I/O pack and the contact input terminal board. All safety contact input modules use the same I/O pack, IS420YDIAS1B. Multiple DIN-rail mounted terminal boards are available to provide the necessary contact voltages, redundancy, and terminal block styles.

The Contact Input module is available in both Simplex and Triple Modular Redundant (TMR) configurations. Users can select the configuration that best addresses their needs for availability and SIL level. This document discusses the Simplex Contact Input (STCI) terminal board and the Contact Input (TBCI) terminal board. The TBCI terminal board offers TMR capability but it can also be used in a Simplex configuration with a single YDIA I/O pack. In a TMR I/O configuration, the controller performs 2-out-of-3 voting on the discrete inputs. In a Dual I/O configuration, the controllers listen to the first reporting YDIA I/O pack (no voting).

STCI Terminal Board with YDIA I/O Pack Specifications

Item	TERMINAL BOARD	
	IS410STCIS2A	IS410STCIS4A
Product Name	Mark VleS 24 V dc Contact Input	Mark VleS 48 V dc Contact Input
Life-cycle Status	Active	Active
I/O Pack Redundancy	Simplex	Simplex
I/O Pack	IS420YDIAS1B (qty 1) (order separately)	IS420YDIAS1B (qty 1) (order separately)
Number of Channels	24 channels per module (24 inputs)	24 channels per module (24 inputs)
Input I/O Wetting Voltage	24 V dc Nominal, 110 mA, floating source to allow ground fault detection 20 V dc min, 32 V dc max	48 V dc Nominal, 110 mA, floating source to allow ground fault detection 43 V dc min, 53 V dc max
I/O Wetting Power Connector	Mate-N-Lok receptacle (AMP 350766-1)	
Field Wiring Terminal Block	Euro style box-type terminal blocks	
Field Wiring	24 AWG min, 12 AWG max	
I/O Scan Time	Configured frame rate of the controller determines I/O scan rate for control	
Sequence of Events (SOE)	Yes, 1 mS SOE sample rate	
Diagnostic Fault Detection	Power-up self test, loss of contact input voltage, non-responding contact input in background test mode, and incorrect terminal board check	
Contact Input Line Monitoring	No	
I/O Pack DC Control Power	24 / 28 V dc, 6.8 W max per YDIA	
I/O Pack DC Power Connector	Micro Mate-N-Lok receptacle (AMP 1445022-3)	
I/O Pack Construction	Aluminum case	
I/O Pack Health	Visual status LEDs, circuit health variables available to control logic	
Termination Module Dimensions (includes cover and I/O pack) (H x W x D)	17.0 x 15.7 x 15.3 cm (6.7 x 6.2 x 6.0 in)	
Safety Rated	Yes, compliant with IEC 61508	
Hazardous Locations Capability	Class 1, Div 2 / Class 2, Zone 2 / ATEX, For ratings and further details, refer to the document <i>Mark VleS Functional Safety System Equipment in Hazardous Locations (HazLoc) Instruction Guide (GEH-6861)</i> .	
G3 Compliant	Yes	
Ambient Operational Temperature	-40 to 70°C (-40 to 158°F)	
Storage Temperature	-40 to 85°C (-40 to 185°F)	
Mounting Method	DIN-rail mounted	
I/O Pack Replacement Part Number	IS420YDIAS1B	
Terminal Board Part Number	IS410STCIS2A	IS410STCIS4A
Module Cover Replacement Part Number	151X1202YE04PP01BL	151X1202YE04PP01BL

Simplex Contact Input (STCI) Terminal Board

The STCI terminal board is a compact contact input terminal board used for Simplex configurations. The STCI accepts 24 contact inputs that are supplied with a nominal 24 or 48 V dc excitation from an external source, or I/O wetting power supply. The contact inputs have noise suppression to protect against surge and high-frequency noise. The YDIA mounts directly on the STCI terminal board. The STCI is available in multiple versions to meet customer requirements. The STCI Terminal Board with YDIA I/O Pack Specifications table provides the specifications for the STCI versions available for use in the Mark VleS Functional Safety System.

Contact Input (TBCI) Terminal Board

The TBCI terminal board is a contact input terminal board used for Simplex, Dual, or TMR configurations. The TBCI accepts 24 dry contact inputs wired to two barrier-type terminal blocks. For contact excitation, dc I/O wetting power is wired to the TBCI. The contact inputs have noise suppression to protect against surge and high-frequency noise. The YDIA I/O pack(s) mount directly on the TBCI terminal board. The TBCI is available in multiple versions to meet customer requirements. The TBCI Terminal Board with YDIA I/O Pack Specifications table provides the specifications for the TBCI versions available for use in the Mark VleS Functional Safety System.

TBCI Terminal Board with YDIA I/O Pack Specifications

Item	TERMINAL BOARD	
	IS410TBCIS2C	IS410TBCIS3C
Product Name	Mark VleS 24 V dc Contact Input	Mark VleS 48 V dc Contact Input
Life-cycle Status	Active	Active
I/O Pack Redundancy	TMR, Dual, or Simplex	TMR, Dual, or Simplex
I/O Pack	IS420YDIAS1B (qty 3, 2, or 1) (order separately)	IS420YDIAS1B (qty 3, 2, or 1) (order separately)
Number of Channels	24 channels per module (24 inputs)	24 channels per module (24 inputs)
Input I/O Wetting Voltage	24 V dc Nominal, 110 mA, floating source to allow ground fault detection 20 V dc min, 32 V dc max	48 V dc Nominal, 110 mA, floating source to allow ground fault detection 43 V dc min, 53 V dc max
I/O Wetting Power Connector	Mate-N-Lok receptacle (AMP 350766-1)	
Field Wiring Terminal Block	Barrier-type terminal blocks	
Field Wiring	22 AWG min, 12 AWG max	
I/O Scan Time	Configured frame rate of the controller determines I/O scan rate for control	
Sequence of Events (SOE)	Yes, 1 mS SOE sample rate	
Diagnostic Fault Detection	Power-up self test, loss of contact input voltage, non-responding contact input in background test mode, and incorrect terminal board check	
Contact Input Line Monitoring	No	
I/O Pack DC Control Power	24 / 28 V dc, 6.8 W max per YDIA	
I/O Pack DC Power Connector	Micro Mate-N-Lok receptacle (AMP 1445022-3)	
I/O Pack Construction	Aluminum case	
I/O Pack Health	Visual status LEDs, circuit health variables available to control logic	
Termination Module Dimensions (includes cover and I/O pack) (H x W x D)	34.0 x 15.7 x 15.3 cm (13.4 x 6.2 x 6.0 in)	
Safety Rated	Yes, compliant with IEC 61508	
Hazardous Locations Capability	Class 1, Div 2 / Class 2, Zone 2 / ATEX. For ratings and further details, refer to the document <i>Mark VleS Functional Safety System Equipment in Hazardous Locations (HazLoc) Instruction Guide (GEH-6861)</i> .	
G3 Compliant	Yes	
Ambient Operational Temperature	-40 to 70°C (-40 to 158°F)	
Storage Temperature	-40 to 85°C (-40 to 185°F)	
Mounting Method	DIN-rail mounted	
I/O Pack Replacement Part Number	IS420YDIAS1B	
Terminal Board Part Number	IS410TBCIS2C	IS410TBCIS3C
Module Cover Replacement Part Number	151X1202YE08PP16BL	151X1202YE08PP16BL

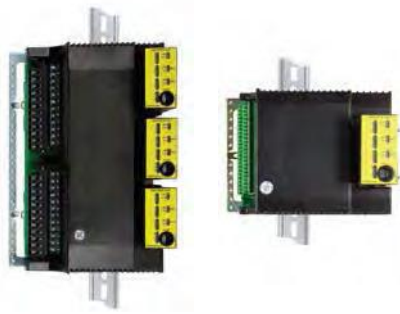

TMR

Simplex

Relay Contact Output Module

The Mark* VleS Functional Safety Relay Contact Output module provides an interface between the discrete process actuators (12 discrete outputs), relay contact outputs, and the Mark VleS Safety control logic. The Relay Contact Output module consists of two orderable parts: the discrete output I/O pack and the relay contact output terminal board. All safety discrete/contact output modules use the same I/O pack, IS420YDOAS1B. Multiple DIN-rail mounted terminal boards and I/O contact wetting/fusing daughterboards are available to provide the necessary contact voltages, contact wetting and fusing configurations, redundancy, and terminal block styles.

The Relay Contact Output module is available in both Simplex and Triple Modular Redundant (TMR) configurations. Users can select the configuration that best addresses their needs for availability and SIL level. This document discusses the Simplex Relay Contact Output (SRLY) terminal board and optional daughterboards for contact wetting and fusing, and the Contact Output (TRLY) terminal board. The TRLY terminal board offers TMR capability, but it can also be used in a Simplex configuration using a single YDOA I/O pack. In a TMR I/O configuration, the I/O terminal board performs 2-out-of-3 voting on the discrete outputs.

Simplex Relay Contact Output (SRLY) Terminal Board

The SRLY terminal board is a simplex S-type terminal board that provides 12 Form-C relay output circuits through 48 customer terminals. The YDOA mounts directly on the SRLY terminal board. The SRLYS2A is available to meet customer safety requirements and there are three available optional daughterboards for contact wetting (WROx) that connect to the SRLYS2A. The SRLY Terminal Board with YDOA I/O Pack Specifications table provides the specifications for the SRLYS2A terminal board and daughterboard versions available for use in the Mark VleS Functional Safety System.

Contact Output (TRLY) Terminal Board

The TRLY terminal board is a relay output terminal board used for Simplex or TMR configurations. The TRLY provides integrity feedback on each relay circuit. The YDOA I/O pack(s) mount directly on the TRLY terminal board. The TRLY is available in multiple versions to meet customer requirements. The TRLY Terminal Board with YDOA I/O Pack Specifications table provides the specifications for the TRLY versions available for use in the Mark VleS Functional Safety System.

For more information on the YDOA I/O pack, the SRLY terminal board and optional daughterboards, and the TRLY terminal board, refer to the chapter “PDOA, YDOA Discrete Output Modules” in the document *Mark VleS Functional Safety Systems for General Market Volume II: System Guide for General-purpose Applications (GEH-6855_Vol_II)*.

SRLY Terminal Board with YDOA I/O Pack Specifications

Item	TERMINAL BOARD	OPTIONAL DAUGHTERBOARD FOR RELAY CONTACT WETTING/FUSING		
	IS410SRLYS2A	IS400WROBH1A	IS400WROFH1A	IS400WROGH1A
Product Name	Mark VleS Form-C relay Output	Contact Wetting Daughterboard	Contact Wetting Daughterboard	Contact Wetting Daughterboard
Life-cycle Status	Active	Active	Active	Active
I/O Pack Redundancy	Simplex	—	—	—
I/O Pack	IS420YDOAS1B (qty 1) (order separately)	—	—	—
Number of Channels	12 Form-C relays (12 DO)	—	—	—
Contact Ratings	0.6 A at 125 V dc 1.2 A at 48 V dc 2.25 A at 24 V dc 2.25 A at 120 / 240 V ac	—	—	—
I/O Contact Wetting & Fusing Configuration	Form-C contacts, dry, no fusing	Contacts 1-6 wetted & dual-fused for Solenoids; Contacts 7-11 dry Form-C, Contact 12 separate I/O wetting	Form-C, no wetting, single fuse in series with each relay common	All 12 relays contacts wetted, single fuse in series with each relay common
I/O Wetting Power Connector	No wetting plug, dry contacts without WROx	Mate-N-Lok receptacle (AMP 350766-1)		
Field Wiring Terminal Block	Euro style box-type terminal blocks	—	—	—
Field Wiring	24 AWG min, 12 AWG max	—	—	—
I/O Scan Time	Configured frame rate of the controller determines I/O scan rate for control	—	—	—
Sequence of Events (SOE)	Configurable for SOE of relay feedbacks	—	—	—
Diagnostic Fault Detection	Power-up self test, I/O pack health, checks commanded output vs feedback, loss of wetting voltage and open fuse detection with WROx, and incorrect terminal board check	Open fuse monitoring via I/O pack diagnostics		
Output Line Monitoring	No	—	—	—
I/O Pack DC Control Power	24 / 28 V dc, 19.8 W max, includes power to drive output relay coils	—	—	—
I/O Pack DC Power Connector	Micro Mate-N-Lok receptacle (AMP 1445022-3)	—	—	—
I/O Pack Construction	Aluminum case	—	—	—
I/O Pack Health	Visual status LEDs, circuit health variables available to control logic	—	—	—
Termination Module Dimensions (includes cover and I/O pack) (H x W x D)	17.0 x 24.9 x 15.3 cm (6.7 x 9.4 x 6.0 in)	Mounts inside IS410SRLYS2A module		
Safety Rated	Yes, compliant with IEC 61508	Non-interfering I/O wetting distribution		
Hazardous Locations Capability	Class 1, Div 2 / Class 2, Zone 2 / ATEX. For ratings and further details, refer to the <i>Mark VleS Functional Safety System Equipment in Hazardous Locations (HazLoc) Instruction Guide (GEH-6861)</i> .			
G3 Compliant	Yes			
Ambient Operational Temperature	-40 to 70°C (-40 to 158°F)			
Storage Temperature	-40 to 85°C (-40 to 185°F)			
Mounting Method	DIN-rail mounted	Daughterboard		
I/O Pack Replacement Part Number	IS420YDOAS1B			
Terminal Board Part Number	IS410SRLYS2A			
Wetting Daughterboard Replacement Part Number	—	IS400WROBH1A	IS400WROFH1A	S400WROGH1A
Module Cover Replacement Part Number	151X1202YE04PP05BL	—	—	—

Mark* VleS Functional Safety System

TRLY Terminal Board with YDOA I/O Pack Specifications

Item	TERMINAL BOARD		
	IS410TRLYS1B	IS410TRLYS1D	IS410TRLYS1F / S2F
Product Name	Mark VleS Relay Output with Coil Sensing	Mark VleS Relay Output with Solenoid Integrity Sensing	Mark VleS Relay Output with TMR Contact Voting
Life-cycle Status	Active	Active	Active
I/O Pack Redundancy	Simplex or TMR	Simplex or TMR	TMR
I/O Pack	IS420YDOAS1B (qty 3 or 1) (order separately)	IS420YDOAS1B (qty 3 or 1) (order separately)	IS420YDOAS1B (qty 3) (order separately)
Number of Channels	12 Form-C relays (12 DO)	6 NO relays, with load integrity monitoring	<ul style="list-style-type: none"> • S1F - 12 NO Relays (Form-A), TMR voted contacts • S2F - 12 NC Relays (Form-B), TMR voted contacts
Contact Ratings	<ul style="list-style-type: none"> • 0.6 A at 125 V dc • 1.2 A at 48 V dc • 8 A at 24 V dc • 3 A at 120 / 240 V ac 	<ul style="list-style-type: none"> • 0.5 A at 125 V dc • 2.25 A at 24 V dc 	<ul style="list-style-type: none"> • 2.25 A at 24 V dc
I/O Contact Wetting & Fusing Configuration	Contacts 1-6 wetted & dual fused for solenoids, Contacts 7-11 dry Form-C, Contact 12 separate I/O wetting	6 NO solenoid contacts, dual fused	Dry Contacts
I/O Wetting Power Connector	Mate-N-Lok receptacle (AMP 350766-1)		
Field Wiring Terminal Block	Barrier-type terminal blocks		
Field Wiring	24 AWG min, 12 AWG max		
I/O Scan Time	Configured frame rate of the controller determines I/O scan rate for control		
Sequence of Events (SOE)	Configurable for SOE of relay feedbacks		
Diagnostic Fault Detection	Power-up self test, I/O pack health, checks commanded output vs feedback, loss of contact wetting voltage, open fuse detection, and incorrect terminal board check	Power-up self test, I/O pack health, solenoid resistance measured to detect open and short circuits, loss of contact wetting voltage, open fuse detection, and incorrect terminal board check	Power-up self test, I/O pack health, checks commanded output vs feedback, and incorrect terminal board check
Contact Output Line Monitoring	No	Solenoid integrity sensing; refer to the section "TRLYH1D, S1D Relay Output with Solenoid Integrity Sensing" in <i>GEH-6855_Vol.II</i> .	No
I/O Pack DC Control Power	24 / 28 V dc, 19.8 W max, includes power to drive output relay coils		
I/O Pack DC Power Connector	Micro Mate-N-Lok receptacle (AMP 1445022-3)		
I/O Pack Construction	Aluminum case		
I/O Pack Health	Visual status LEDs, circuit health variables available to control logic		
Termination Module Dimensions (includes cover and I/O pack) (H x W x D)	34.0 x 24.9 x 15.3 cm (13.4 x 9.4 x 6.0 in)		
Safety Rated	Yes, compliant with IEC 61508		
Hazardous Locations Capability	Class 1, Div 2 / Class 2, Zone 2 / ATEX. For ratings and further details, refer to the <i>Mark VleS Functional Safety System Equipment in Hazardous Locations (HazLoc) Instruction Guide (GEH-6861)</i> .		
G3 Compliant	Yes		
Ambient Operational Temperature	-40 to 70°C (-40 to 158°F)		
Storage Temperature	-40 to 85°C (-40 to 185°F)		
Mounting Method	DIN-rail mounted		
I/O Pack Replacement Part Number	IS420YDOAS1B		
Terminal Board Part Number	IS410TRLYS1B	IS410TRLYS1D	IS410TRLYS1F / IS410TRLYS2F
Module Cover Replacement Part Number	151X1202YE08PP18BL	151X1202YE08PP18BL	151X1202YE08PP14BL / 151X1202YE08PP14BL



Vibration Input Module

The Mark* VleS Functional Safety Vibration Input module provides an interface between eddy-current (position, velocity, and key-phasor), seismic (velocity), velometer (velocity), accelerometer with integrated output (velocity), and charge amplifier (dynamic pressure probe interface for acoustics) sensors, and Mark VleS Safety certified vibration algorithms. The Vibration Input module consists of two orderable parts: the Vibration Input IS420YVIBS1B I/O pack and the Vibration Input IS410TVBAS2B terminal board. The Vibration Input module is available in both Simplex and Triple Modular Redundant (TMR) configurations.

The IS420YVIBS1B I/O pack provides the following IEC61508 certified algorithms:

- Configurable gain and sensor bias nulling to maximize the resolution of the time series AC content
- Gap measurement between eddy-current sensor head and rotating member of machine for channels 1 through 13
- RPM and position information relative to rotor's key-phasor for channels 12 and 13
- Vibration displacement using peak-to-peak and true RMS calculations of passband filtered, broadband time-series sampled inputs for channels 1 through 8
- Vibration magnitude and phase from tracking filters using a rotor's key-phasor input for channels 1 through 8
- Magnitude only from tracking filters using speed inputs from the Safety controller
- Configurable limit checks on all algorithm results

The IS410TVBAS2B terminal board provides buffered outputs through BNC connectors or four D-shell connectors to some third-party devices. The following table provides the specifications for the IS410TVBAS2B terminal board.

For more information on the YVIB I/O pack and the TVBA terminal board, refer to the chapter "PVIB, YVIB Vibration Monitor Modules" in the document *Mark VleS Functional Safety Systems for General Market Volume II: System Guide for General-purpose Applications (GEH-6855_Vol_II)*.

Mark* VleS Functional Safety System

TVBA Terminal Board with YVIB I/O Pack Specifications

Item	IS410TVBAS2B Terminal Board
Product Name	Mark VleS Vibration Input
Life-cycle Status	Active
I/O Pack Redundancy	Simplex or TMR
I/O Pack	IS420YVIBS2B (qty 3 or 1) (order separately)
Number of Channels	13 channels per module
Common Mode Voltage	-13.5 V dc min, +13.5 V dc max
CMRR at 50/60 Hz	-50 dB
Input passband frequency	4300 Hz
Sample Frequency	10,000 Hz
Eddy-current Displacement Measurement Accuracy	± 0.02 Vpp at 10 Hz ± 0.023 Vpp at 200 Hz ± 0.056 Vpp at 700 Hz
Seismic Velocity Measurement Accuracy	± 0.01 Vp at 10 Hz ± 0.012 Vp at 200 Hz ± 0.034 Vp at 700 Hz
Dynamic Pressure Measurement Accuracy	± 0.01 Vp at 10 Hz ± 0.132 Vp at 1000 Hz
Key-phasor RPM	0.1% of reading Range: 2 to 20,000 Hz
Phase	± 0.5 degrees at 333 Hz ± 1 degree at 667 Hz
Sensor Power	-24 V dc at 12 mA per transducer
Buffered Outputs	0.1% of full scale
Field Wiring Terminal Block	Barrier-type terminal blocks
Field Wiring	22 AWG min, 12 AWG max
I/O Scan Time	Supported controller I/O scan rates: 10 ms, 40 ms, 80 ms, 160 ms
Diagnostic Fault Detection	Power-up self test, continuous monitoring of power supplies, both configurable sensor limit and system function limit checks, and incorrect terminal board check
Sensor Input Line Monitoring	Open/Short circuit detection for sensor outputs with DC bias, but not for zero bias signals
I/O Pack DC Control Power	28 V dc, 12 W max per YVIB
I/O Pack DC Power Connector	Micro Mate-N-Lok receptacle (AMP 1445022-3)
I/O Pack Construction	Aluminum case
I/O Pack Health	Visual status LEDs, circuit health variables available to control logic
Termination Module Dimensions (includes cover and I/O pack) (H x W x D)	34.0 x 24.9 x 15.3 cm (13.4 x 9.4 x 6.0 in)
Safety Rated	Yes, compliant with IEC 61508
Hazardous Locations Capability	Class 1, Div 2 / Class 2, Zone 2 / ATEX. For ratings and further details, refer to the document <i>Mark VleS Functional Safety System Equipment in Hazardous Locations (HazLoc) Instruction Guide (GEH-6861)</i> .
G3 Compliant	Yes
Ambient Operational Temperature	-40 to 70°C (-40 to 158°F)
Storage Temperature	-40 to 85°C (-40 to 185°F)
Mounting Method	DIN-rail mounted
I/O Pack Replacement Part Number	IS420YVIBS1B
Terminal Board Part Number	IS410TVBAS2B
Module Cover Replacement Part Number	151X1202YE08PP14BL



Universal Analog I/O Module

The Mark* VleS Functional Safety IS430SSUAH1A Universal Analog Input/Output (I/O) module is an enhanced I/O device that offers users significant flexibility as compared to traditional analog I/O modules. Each of the 16 points of I/O can be uniquely configured to any of the 10 different I/O types. This flexibility allows optimization during the system design phase, lowering cabinet footprint and reducing system cost. The module facilitates last-minute field changes through simple software reconfiguration of individual I/O points for faster commissioning. Your project stays on schedule and on budget. It also provides flexibility for upgrades and expansions by simply reconfiguring the point to match the type of I/O being connected.

The Universal Analog I/O module consists of a Universal Analog IS420YUAAAS1A I/O pack mounted on an IS410SUAAAS1A terminal board. The ordering part number is IS430SSUAH1A (complete Universal Analog I/O module). The module is only available in a Simplex configuration.

Sixteen Simplex Analog channels can be configured individually as any of the following types: Thermocouple (TC), Resistance Temperature Device (RTD), voltage input (± 5 V or ± 10 V), 4 to 20 mA current input, 0 to 20 mA current output, pulse accumulator, digital input (DI), and digital output (DO). Highway Addressable Remote Transducer (HART[®]) is optional for all internally powered mA input modes. There are two connections per Analog channel that provide I/O signal + and return for the mA output mode, which also supports HART.

The YUAA I/O pack supports several types of digital (discrete) inputs and outputs, as enabled by the configuration, including: digital input modes of NAMUR, and externally wetted, internally wetted, and digital outputs using mA outputs and interposing relays.

The Universal Analog I/O module also supports a simple Pulse Accumulator input that counts pulse edges on an input channel across a specified threshold voltage up to a limited frequency.

The following table provides the specifications for the Universal Analog I/O module. For more information on the YUAA I/O pack and the SUAAS1A terminal board, refer to the chapter "PUAA, YUAA Universal I/O Modules" in the document *Mark VleS Functional Safety Systems for General Market Volume II: System Guide for General-purpose Applications (GEH-6855_Vol_II)*.

Mark* VleS Functional Safety System

Universal Analog I/O Module Specifications

Item	IS430SSUAH1A Specification
Product Name	Mark VleS Universal Analog I/O
Life-cycle Status	Active
I/O Pack Redundancy	Simplex
I/O Pack	IS420YUAA51A (qty 1) (order separately)
Number of Channels	16 channels per module
Supported I/O Types	<ul style="list-style-type: none"> • Thermocouple (TC) • RTD • 4 to 20 mA current input with HART option • ± 5 or ± 10 V input • 0 to 20 mA current output with HART option • Digital inputs (DI) and digital outputs (DO) • Pulse accumulators
mA / HART Inputs	4 to 20 mA at 0.1% accuracy over temperature range
Voltage Inputs	± 5 V dc or ± 10 V dc at 0.1% accuracy over temperature range
Input Span	4 to 20 mA dc with allowance for 0 to 24 mA to cover NAMUR fault conditions
HART Rx and Cx Values	250 Ω in parallel with 5,000 pF for inputs; 14 kΩ with 11,000 pF for outputs
mA Outputs	0 to 20 mA with 0.5% accuracy, compliance up to 18 V dc with 22 V dc or higher field supply
Output Converter	16-bit D/A converter with 0.5% accuracy over 0 to 24 mA
Output Load	800 Ω for 0 to 20 mA output
Thermocouples	E, J, K, S, T, B, N, R with 0.1% measurement accuracy of full scale. Local / Remote Cold Junction options ± 16.7°C (2°F) (±15.5°C, 4°F if I/O configured for mA outputs)
RTD	<ul style="list-style-type: none"> • 120 Ω Nickel ± 16.7°C (2°F) at 204.4°C (400°F) • 100 Ω Platinum ± 15.6°C (4°F) at 204.4°C (400°F) • 200 Ω Platinum ± 16.7°C (2°F) at 204.4°C (400°F) • 10 Ω Copper ± 12.2°C (10°F) at 204.4°C (400°F) Resistance up to 450 Ω; scan time: 500 ms • 2 and 3 wire support
Discrete Inputs	<ul style="list-style-type: none"> • 10 to 20 V external wetted switches into 12.5 kΩ internal load line monitoring • -22 to 30 V external wetted switches using a series or series-parallel set of 8.2 kΩ • Internal wetted switches with 10 mA contact current, 22 V open contact volt
Discrete Outputs	0 to 24 mA at up to 22 V using mA output mode
Pulse Accumulators	16-bit; voltage range: -10 to 20 V; frequency range: 0 to 500 Hz
Input Converter Resolution	16-bit analog-to-digital converter
Measurement Accuracy	Better than 0.1% full scale over the temperature range -40 to 70°C (-40 to 158°F)
Common Mode Rejection	<ul style="list-style-type: none"> • AC common mode rejection 60 dB at 60 Hz, with up to ± 5 V common mode voltage • DC common mode rejection 80 dB with -5 to +7 peak V common mode voltage
Field Wiring	24 AWG min, 12 AWG max
I/O Scan Time	Supported controller I/O scan rates: 10 ms, 40 ms, 80 ms, 160 ms
Diagnostic Fault Detection	Power-up self test, support for all I/O types, continuous monitoring of power supplies, both configurable sensor limit and system function limit checks, and incorrect terminal board check
Sensor Input Line Monitoring	Open/Short circuit detection for sensor outputs with DC bias, but not for zero bias signals
I/O Pack DC Control Power	28 V dc, 8.1 W quiescent plus power per channel: <ul style="list-style-type: none"> • TC, 5 V, 10 V, external wetted DI, pulse accumulator, or RTD = 0.02 W per channel • External fed mA input and internal wetted DI = 0.04 W per channel • Internal fed mA input or mA output = 0.68 W per channel
I/O Pack DC Power Connector	Phoenix [®] contact (MC1.5/S-STF-3.81) (included)
I/O Pack Construction	Aluminum case
I/O Pack Health	Visual status LEDs, circuit health variables available to control logic
Termination Module Dimensions (includes cover and I/O pack) (H x W x L)	11.2 x 8.6 x 16.8 cm (4.4 x 3.4 x 6.6 in)
Safety Rated	Yes, compliant with IEC 61508
Hazardous Locations Capability	Class 1, Div 2 / Class 2, Zone 2 / ATEX. For ratings and further details, refer to the document <i>Mark VleS Functional Safety System Equipment in Hazardous Locations (HazLoc) Instruction Guide (GEH-6861)</i> .
G3 Compliant	Yes
Ambient Operational Temperature	-40 to 70°C (-40 to 158°F)
Storage Temperature	-40 to 85°C (-40 to 185°F)
Mounting Method	DIN-rail mounted
Module Replacement Part Number	IS430SSUAH1A

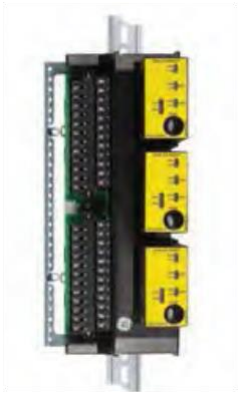

TMR



Simplex

Analog I/O Module

The Mark* VleS Functional Safety Analog Input / Output (I/O) module provides an interface between the process analog sensors / actuators (10 analog inputs and two analog outputs) and the Mark VleS Safety control logic. The Analog I/O module consists of two orderable parts: the Analog I/O pack and the Analog I/O terminal board. All safety Analog I/O modules use the same Analog I/O pack, IS420YAICS1B. There are two DIN-rail mounted Analog I/O terminal boards available to provide the necessary redundancy and terminal block styles. Users can select the configuration that best addresses their needs for availability and SIL level. The Analog I/O module is available in both Simplex and Triple Modular Redundant (TMR) configurations. This document discusses the Simplex Analog I/O (IS410STAIS2A) terminal board and the TMR Analog I/O (IS410TBAIS1C) terminal board.

In a TMR configuration, the controller selects the median analog input values returned by the TMR I/O pack(s) (thus rejecting a high or low out of range value) and the I/O pack electronics combine the analog outputs with a patented circuit design that rejects a bad performing I/O pack.

Simplex Analog I/O (STAI) Terminal Board

The STAI terminal board is a compact analog input terminal board that accepts 10 analog inputs and two analog outputs, and connects to the YAIC I/O pack. The 10 analog inputs accommodate two-wire, three-wire, four-wire, or externally powered transmitters. The analog outputs are configured for 0 to 20 mA. An on-board ID chip identifies the board to the I/O pack for system diagnostic purposes.

TMR Analog I/O (TBAI) Terminal Board

The TBAI terminal board is an analog input terminal board used in TMR and Simplex configurations that supports 10 analog inputs and two outputs, and connects to the YAIC I/O pack. The 10 analog inputs accommodate two-wire, three-wire, four-wire, or externally powered transmitters. The analog outputs can be configured for 0 to 20 mA. Inputs and outputs have noise suppression circuitry to protect against surge and high frequency noise. The TBAI has three DC-37 pin connectors for three TMR I/O packs or one Simplex I/O pack.

The Analog I/O Terminal Board with YAIC I/O Pack Specifications table provides the specifications for the Analog I/O terminal boards available for use in the Mark VleS Functional Safety System. For more information on the YAIC I/O pack and the STAI and TBAI terminal boards, refer to the chapter “PAIC, YAIC Analog I/O Modules” in the document *Mark VleS Functional Safety Systems for General Market Volume II: System Guide for General-purpose Applications (GEH-6855_Vol_II)*.

Analog I/O Terminal Board with YAIC I/O Pack Specifications

Item	TERMINAL BOARD	
	IS410STAIS2A	IS410TBAIS1C
Product Name	Mark VleS Analog I/O	Mark VleS Analog I/O
Life-cycle Status	Active	Active
I/O Pack Redundancy	Simplex	Simplex or TMR
I/O Pack	IS420YAICS1B (qty 1) (order separately)	IS420YAICS1B (qty 3 or 1) (order separately)
Number of Channels	12 channels per module (10 AI, 2 AO)	12 channels per module (10 AI, 2 AO)
Analog Input Span	<ul style="list-style-type: none"> AI channel 1-8: 1 to 5 V dc, ± 5 V dc, ± 10 V dc, 0 to 20 mA AI channel 9-10: 0 to 20 mA, ± 1 mA 	<ul style="list-style-type: none"> AI channel 1-8: 1 to 5 dc, ± 5 V dc, ± 10 V dc, 0 to 20 mA AI channel 9-10: 0 to 20 mA, ± 1 mA
Analog Input Converter Resolution	16-bit A/D Converter	16-bit A/D Converter
Analog Input Accuracy	0.1% of full scale over the full operating temperature range	0.1% of full scale over the full operating temperature range
Analog Input Noise Suppression	<ul style="list-style-type: none"> Hardware filter with single pole down break at 500 rad/sec Software filter using a two pole low pass filter, configurable for 0.75 Hz, 1.5 Hz, 3 Hz, 6 Hz, or 12 Hz 	<ul style="list-style-type: none"> Hardware filter with single pole down break at 500 rad/sec Software filter using a two pole low pass filter, configurable for 0.75 Hz, 1.5 Hz, 3 Hz, 6 Hz, or 12 Hz
Analog Input Common Mode Rejection	<ul style="list-style-type: none"> AC CMR 60 dB at 60 Hz, up to ± 5 V common mode voltage DC CMR 80 dB with -5 to +7 V peak common mode rejection 	<ul style="list-style-type: none"> AC CMR 60 dB at 60 Hz, up to ± 5 V common mode voltage DC CMR 80 dB with -5 to +7 V peak common mode rejection
Analog Input Common Mode Voltage Range	± 5 V (± 2 V CMR for the ± 10 V inputs)	± 5 V (± 2 V CMR for the ± 10 V inputs)
Analog Output Accuracy	0.5%	0.5%
Analog Output Converter Resolution	14-bit D/A Converter	14-bit D/A Converter
Analog Output Load	800 Ω max for 0 to 20 mA output	800 Ω max for 0 to 20 mA output
Field Wiring Terminal Block	Euro style box-type terminal blocks	Barrier-type Terminal Blocks
Field Wiring	24 AWG min, 12 AWG max	22 AWG min, 12 AWG max
I/O Scan Time	Supported Controller I/O Scan rates: 10 ms, 40 ms, 80 ms, 160 ms	
Diagnostic Fault Detection	Power-up self test, continuous monitoring of internal power supplies, incorrect terminal board check, hardware limit checking based on configurable high and low levels for 4-20 mA inputs, health of D/A convert circuits, analog output current contribution monitoring, and suicide relay disconnects failed outputs in TMR configuration to allow other two I/O packs to control	
I/O Pack DC Control Power	28 V dc at 8 W control power per YAIC; up to additional 7 W depending on how much of 4-20 mA sensor power is sourced from Analog I/O terminal board	
I/O Pack DC Power Connector	Micro Mate-N-Lok receptacle (AMP 1445022-3)	
I/O Pack Construction	Aluminum case	
I/O Pack Health	Visual status LEDs, circuit health variables available to control logic	
Termination Module Dimensions (includes cover and I/O pack) (H x W x D)	17.0 x 15.7 x 15.3 cm (6.7 x 6.2 x 6.0 in)	
Safety Rated	Yes, compliant with IEC 61508	
Hazardous Locations Capability	Class 1, Div 2 / Class 2, Zone 2 / ATEX. For ratings and further details, refer to the document <i>Mark VleS Functional Safety System Equipment in Hazardous Locations (HazLoc) Instruction Guide (GEH-6861)</i> .	
G3 Compliant	Yes	
Ambient Operational Temperature	-40 to 70°C (-40 to 158°F)	
Storage Temperature	-40 to 85°C (-40 to 185°F)	
Mounting Method	DIN-rail mounted	
I/O Pack Replacement Part Number	IS420YAICS1B	
Terminal Board Part Number	IS410STAIS2A	IS410TBAIS1C
Module Cover Replacement Part Number	151X1202YE04PP01BL	151X1202YE08PP16BL



UCSC Controller

The Mark* Vle and Mark VleS Functional Safety UCSC controller is a compact, stand-alone controller that runs application-specific control system logic. It can be used in a diverse range of applications, from small industrial controllers to large combined-cycle power plants. The UCSC controller is a base-mounted module, with no batteries, no fans, and no hardware configuration jumpers. All configuration is done through software settings that can be conveniently modified and downloaded using the Mark controls platform software configuration application, ToolboxST*, running on a Microsoft® Windows® operating system. The UCSC controller communicates with I/O modules (Mark Vle and Mark VleS I/O packs) through on-board I/O network (IONet) interfaces.

The Mark VleS Safety controller, IS420UCSCS2A, is a dual core controller that runs the Mark VleS Safety control applications used for functional safety loops to achieve SIL 2 and SIL 3 capabilities. The Mark VleS Safety product is used by operators that are knowledgeable in safety-instrumented system (SIS) applications to reduce risk in safety functions. The UCSCS2A controller can be configured for Simplex, Dual, and TMR redundancy.

The non-safety Mark Vle controller, IS420UCSCH1B, can be interfaced with the Safety control system (through EGD protocol on UDH Ethernet port) as a controller for non-SIF loops or as a simple communication gateway to provide data with OPC® UA Server or Modbus® Master feedback signals, if needed by the application.

The following table provides the specifications for the UCSC controllers. For more information on the UCSC controller, refer to “UCSC Controllers” in the document *Mark VleS Functional Safety Systems for General Market Volume II: System Guide for General-purpose Applications (GEH-6855_Vol_II)*.

Mark* VleS Functional Safety System

UCSC Controller Specifications

Item	CONTROLLER	
	IS420UCSCS2A	IS420UCSCH1B
Product Name	Mark VleS Safety Controller	Mark Vle Gateway Controller
Life-cycle Status	Active	Active
Redundancy Configurations	Simplex, Dual, and TMR	Simplex, Dual
Safety Controller	Yes, compliant with IEC 61508	Non-interfering
Microprocessor	Dual core, 1.6 GHz AMD G-Series	Quad core, 1.2 GHz AMD G-Series
Memory	2 GB DDR3-1066 SDRAM, with error correcting code (ECC)	2 GB DDR3-1066 SDRAM, with error correcting code (ECC)
Memory Storage	128 GB Solid State Drive	128 GB Solid State Drive
Non-Volatile SRAM	No	Supports 3,067 non-volatile program variables, 338 forces, and 64 totalizers
Ethernet Ports/Controller Communications Support	3 IONet ports (R/S/T) for I/O module communications (simplex, dual, and TMR supported); ENET 1 - EGD/UDH communications to ToolboxST PC, HMIs, UCSCH1B Gateway controller, and GE PACSystems products; Modbus TCP Slave, Read-only; Supports Black Channel communication between other Mark VleS Safety controllers	3 IONet ports (R/S/T) for I/O module communications (simplex, dual, TMR, and Shared I/O supported). ENET 1 - EGD/UDH communications to ToolboxST PC, HMIs, UCSCS2A Safety controller, and GE PACSystems products. Modbus TCP Slave, Read/Write. ENET 2 - Secondary UDH communications, Modbus TCP Slave and OPC UA. IICS Cloud port for Embedded Field Agent (EFA).
Supports Modbus Master with PSCA	No	Yes, through IONet ports to PSCA; Refer to <i>Mark Vle Modbus Master Communication Module Summary Sheet (GEI-100868)</i> .
Health and Status LEDs	Power, Boot, Online, Ethernet link and activity, and Diagnostics LEDs. Refer to the section "UCSC Controllers" in the document <i>Mark VleS Functional Safety Systems for General Market Volume II: System Guide for General-purpose Applications (GEH-6855_Vol_II)</i> .	
Input Power	18 to 30 V dc, 28 V dc nominal, 30.8 W max	
Input Power Connector	Phoenix® contact (MC 1,5 / 3-STF-3,81 - 1827716) (Included)	
Programming	<ul style="list-style-type: none"> • Function Block Diagram (FBD) • Relay Ladder Diagram (RLD) • Cause and Effect Matrix Refer to <i>ToolboxST User Guide for Mark Controls Platform (GEH-6703)</i> .	<ul style="list-style-type: none"> • Function Block Diagram (FBD) • Relay Ladder Diagram (RLD) • Sequential Function Chart (SFC) Refer to <i>ToolboxST User Guide for Mark Controls Platform (GEH-6703)</i> .
Control Logic Execution (Frame Rate)	10 ms, 40 ms, 80 ms, 160 ms (synchronization across controllers in frame for Dual and TMR configurations)	
Dimensions (H x W x D)	<ul style="list-style-type: none"> • UCSC: 168 x 150 x 55 mm (6.6 x 5.9 x 2.2 in) • UCSC with mounting base: 204 x 152 x 55 mm (8.0 x 6.0 x 2.2 in) 	
Weight	1,327 g (46.8 oz)	
Mounting Method	Base-mounted. For mounting details and spacing requirements details, refer to the section "UCSC Controllers" in the document <i>Mark VleS Functional Safety Systems for General Market Volume II: System Guide for General-purpose Applications (GEH-6855_Vol_II)</i> .	
Cooling	Convection	
Hazardous Locations Capability	Class 1, Div 2 / Class 2, Zone 2 / ATEX. For ratings and further details, refer to <i>Mark VleS Functional Safety System Equipment in Hazardous Locations (HazLoc) Instruction Guide (GEH-6861)</i> .	
G3 Compliant	Yes	
Ambient Operational Temperature	-40 to 70°C (-40 to 158°F); ambient 25 mm (0.98 in) from any point on UCSC	
Storage Temperature	-40 to 85°C (-40 to 185°F)	
Humidity	95% non-condensing	
Controller Replacement Part Number	IS420UCSCS2A	IS420UCSCH1B



Modbus Master Communication Module

The Mark* Vle Modbus Master (Serial Communication) module provides Modbus Master protocol from the Gateway controller to other devices via Serial or Ethernet media. The Modbus Master module consists of two orderable parts: the Serial Communication IS420PSCAH1B I/O pack and the Simplex Serial Communication Input/Output (I/O) IS410SSCAH2A terminal board. The module is only available in a Simplex configuration.

The Modbus Master module supports six serial transceiver channels, each of which can be individually configured to comply with RS-232, RS-422, or RS-485 half-duplex requirements. Jumpers on the SSCA terminal board are used to set up the termination scheme for the selected communication mode. Up to six channels can be configured for Serial Modbus Master service.

Additionally, the PSCA I/O pack can use one of two Ethernet ports to support the Ethernet TCP Modbus Master protocol. The Ethernet Modbus implementation follows the open Modbus/TCP specification for a Class 1 device.

The following table provides the specifications for the IS410SSCAH2A terminal board. For more information on the PSCA I/O pack and the SSCA terminal board, refer to the chapter “PSCA Serial Communication Module” in the document *Mark VleS Functional Safety Systems for General Market Volume II: System Guide for General-purpose Applications (GEH-6855_Vol_II)*.

For more information on the Mark Vle Gateway controller, refer to the document *Mark Vle and Mark VleS Functional Safety UCSC Controller Summary Sheet (GEI-100867)*.

SSCA Terminal Board with PSCA I/O Pack Specifications

Item	IS410SSCAH2A Terminal Board
Product Name	Mark Vle Serial Communication
Life-cycle Status	Active
I/O Pack Redundancy	Simplex
I/O Pack	IS420PSCAH1B (qty 1) (order separately)
Number of Channels	<ul style="list-style-type: none"> • 6 Independently configured serial Modbus Master channels • 1 Ethernet Modbus Master channel (with Simplex IONet configuration)
Communication Choices	<ul style="list-style-type: none"> • RS-232 mode • RS-422 mode • RS-485 mode, half-duplex only • Ethernet Modbus Master mode
Ethernet Modbus Master Mode	<ul style="list-style-type: none"> • Number of Ethernet Modbus stations: 18 max • Configurable transfer rate: 0.5, 1, 2, or 4 Hz • Supported function codes: 1 to 7, 15, and 16
RS-232C Mode	<ul style="list-style-type: none"> • Cable distance: 15 m (50 ft) • Communication rate: up to 115.2 kbps
RS-422 Mode	<ul style="list-style-type: none"> • Cable distance: 305 m (1000 ft) • Communication rate: up to 115.2 kbps • Number of drops: 8 max
RS-485 Mode	<ul style="list-style-type: none"> • Cable distance: 305 m (1000 ft) • Communication Rate: up to 375 kbps
Termination Resistors	Jumper selectable between open or 121 Ω
RS-232C Return Path Ground	Jumper selectable between resistive ground of 100 Ω or 1 MΩ
Field Wiring Terminal Block	Euro Style Box-type terminal blocks
Field Wiring	24 AWG min, 12 AWG max
Diagnostic Fault Detection	Power-up self test, continuous monitoring of internal power supplies, and incorrect terminal board check
I/O Pack DC Control Power	24 / 28 V dc at 10 W max
I/O Pack DC Power Connector	Micro Mate-N-Lok receptacle (AMP 1445022-3)
I/O Pack Construction	Aluminum case
I/O Pack Health	Visual status LEDs, circuit health variables available to control logic
Termination Module Dimensions (includes cover and I/O pack) (H x W x D)	17.0 x 15.7 x 15.3 cm (6.7 x 6.2 x 6.0 in)
Safety Rated	No
Hazardous Locations Capability	Class 1, Div 2 / Class 2, Zone 2 / ATEX. For ratings and further details, refer to the document <i>Mark VleS Functional Safety System Equipment in Hazardous Locations (HazLoc) Instruction Guide (GEH-6861)</i> .
G3 Compliant	Yes
Ambient Operational Temperature	-40 to 70°C (-40 to 158°F)
Storage Temperature	-40 to 85°C (-40 to 185°F)
Mounting Method	DIN-rail mounted
I/O Pack Replacement Part Number	IS420PSCAH1B
Terminal Board Part Number	IS410SSCAH2A
Module Replacement Part Number	151X1202YE04PP01BL



IS420ESWAH#A

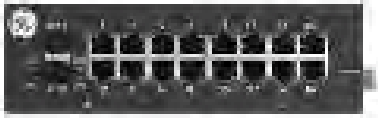

IS420ESWBH#A

Industrial Ethernet / IONet Switches

GE's product line of industrial, unmanaged Ethernet 10/100 switches, ESWA and ESWB, are specifically designed to meet the needs of real-time industrial control solutions and are required for all IONet switches used in a Mark* Vle and Mark VleS Safety control system. To meet the requirements for speed and functionality, the following features are provided:

- 802.3, 802.3u, and 802.3x compatibility
- 10/100 base copper with auto negotiation
- Full/half duplex auto-negotiation
- 100 Mbps FX uplink port
- HP-MDIX auto sensing
- LEDs to indicate status of Link Presence, Activity and Duplex, and Speed per port (each LED has two colors)
- LED to indicate power status
- Minimum 256 KB buffer with 4 K media access control (MAC) addresses
- Redundant power supply inputs (Diode-OR'd)

The GE Ethernet/IONet switches are available in two hardware forms: ESWA and ESWB. Each hardware form is available in five versions (H1A through H5A) that vary in fiber-optic port configuration options, which include no fiber ports, multi-mode fiber ports, or single-mode (longer distance) fiber ports. Refer to the IS420ESWAH#A IONet Switch Specifications table and the IS420ESWBH#A IONet Switch Specifications table for these fiber option details.

Clip Part #	Switch Usage	Mounting Orientation
259B2451BVP1	ESWA (8-port) or SWB (16-port)	Long edge of switch body parallel to rail
259B2451BVP2	ESWA (8-port)	Long edge of switch body perpendicular to rail
259B2451BVP4	ESWB (16-port)	Long edge of switch body perpendicular to rail

The ESWx switches can be DIN-rail mounted using one of three GE qualified DIN-rail mounting clips, depending on the hardware form (ESWA or ESWB) and the selected DIN-rail mounting orientation. The clips are ordered separately, in accordance with the following table. Mounting screws are included with each switch.

For more information on the ESWx switches, refer to the section "ESWA and ESWB Industrial Unmanaged Ethernet Switches" in the document *Mark VleS Functional Safety Systems for General Market Volume II: System Guide for General-purpose Applications (GEH-6855_Vol_II)*.

Mark* VleS Functional Safety System

IS420ESWAH#A IONet Switch Specifications

Item	IONet Switch				
	IS420ESWAH1A	IS420ESWAH2A	IS420ESWAH3A	IS420ESWAH4A	IS420ESWAH5A
Product Name	Mark Vle IONet Switch	Mark Vle IONet Switch	Mark Vle IONet Switch	Mark Vle IONet Switch	Mark Vle IONet Switch
Life-cycle Status	Active	Active	Active	Active	Active
Copper Ports	8 ports, 10/100Base-TX copper, RJ-45	8 ports, 10/100Base-TX copper, RJ-45	8 ports, 10/100Base-TX copper, RJ-45	8 ports, 10/100Base-TX copper, RJ-45	8 ports, 10/100Base-TX copper, RJ-45
Fiber Ports	1 port 100Base-FX, multi-mode fiber, LC-type connection	2 ports 100Base-FX, multi-mode fiber, LC-type connection	No fiber ports	1 port 100Base-LX10, -mode fiber, LC-type connection	2 ports 100Base-LX10, single-mode fiber, LC-type connection
Power Requirements	24 / 28 V dc, 1 A max, TB1 and TB2 provide inputs for two independent power sources that are Diode-OR'd for redundant power				
Power Supply Connector	Phoenix® contact (MC 1.5/S-STF-3.81) (qty 2, Included)				
Dimensions (H x W x D)	13.8 x 8.6 x 5.6 cm (5.4 x 3.40 x 2.20 in)				
Copper Cables	Cat 5e UTP cable with RJ-45 connectors (8P8C)				
Cooling	Convection cooled				
Safety Rated	Non-interfering				
Hazardous Locations Capability	Class 1, Div 2 / Class 2, Zone 2 / ATEX. For ratings and further details, refer to the document <i>Mark VleS Functional Safety System Equipment in Hazardous Locations (HazLoc) Instruction Guide (GEH-6861)</i> .				
G3 Compliant	Yes				
Ambient Operational Temperature	-40 to 70°C (-40 to 158°F)				
Storage Temperature	-40 to 85°C (-40 to 185°F)				
Mounting Method	DIN-rail mounted with separately purchased mounting clip				
Switch Replacement Part Number	IS420ESWAH1A	IS420ESWAH2A	IS420ESWAH3A	IS420ESWAH4A	IS420ESWAH5A

IS420ESWBH#A IONet Switch Specifications

Item	IONet Switch				
	IS420ESWBH1A	IS420ESWBH2A	IS420ESWBH3A	IS420ESWBH4A	IS420ESWBH5A
Product Name	Mark Vle IONet Switch	Mark Vle IONet Switch	Mark Vle IONet Switch	Mark Vle IONet Switch	Mark Vle IONet Switch
Life-cycle Status	Active	Active	Active	Active	Active
Copper Ports	16 ports, 10/100Base-TX copper, RJ-45	16 ports, 10/100Base-TX copper, RJ-45	16 ports, 10/100Base-TX copper, RJ-45	16 ports, 10/100Base-TX copper, RJ-45	16 ports, 10/100Base-TX copper, RJ-45
Fiber Ports	1 port 100Base-FX, multi-mode fiber, LC-type connection	2 ports 100Base-FX, multi-mode fiber, LC-type connection	No fiber ports	1 port 100Base-LX10, -mode fiber, LC-type connection	2 ports 100Base-LX10, single-mode fiber, LC-type connection
Power Requirements	24 / 28 V dc, 1 A max, TB1 and TB2 provide inputs for two independent power sources that are Diode-OR'd for redundant power				
Power Supply Connector	Phoenix® contact (MC 1.5/S-STF-3.81) (qty 2, Included)				
Dimensions (H x W x D)	18.8 x 8.6 x 5.6 cm (7.40 x 3.40 x 2.20 in)				
Copper Cables	Cat 5e UTP cable with RJ-45 connectors (8P8C)				
Cooling	Convection cooled				
Safety Rated	Non-interfering				
Hazardous Locations Capability	Class 1, Div 2 / Class 2, Zone 2 / ATEX. For ratings and further details, refer to the document <i>Mark VleS Functional Safety System Equipment in Hazardous Locations (HazLoc) Instruction Guide (GEH-6861)</i> .				
G3 Compliant	Yes				
Ambient Operational Temperature	-40 to 70°C (-40 to 158°F)				
Storage Temperature	-40 to 85°C (-40 to 185°F)				
Mounting Method	DIN-rail mounted with separately purchased mounting clip				
Switch Replacement Part Number	IS420ESWBH1A	IS420ESWBH2A	IS420ESWBH3A	IS420ESWBH4A	IS420ESWBH5A



Power Distribution Module

The Mark* Vle Power Distribution Module (PDM) offers a set of inter-connectable products to provide core system power for control electronics and I/O contact wetting and wiring protection within the control system. When using GE's power distribution parts, users benefit from the following features:

- Automatic power monitoring and diagnostics to the controller, which alerts operations and maintenance teams and eliminates manual programming and extra I/O for power monitoring
- Proven power distribution scheme with coordinated fault protection and isolation
- Segregation of control and contact wetting power to avoid field wiring issues from damaging control components
- Flexible redundancy schemes for most applications that support Dual or TMR options
- Simplified power schemes to reduce panel fabrication, assembly, and test time and shorten the panel build phase of projects

PDM products include:

- IS410JPDx series of DIN-rail mountable PDMs distribute control power and I/O wetting power within the control system
- Power Distribution Diagnostic Feedback I/O pack (IS420PPDAH1B) monitors control and wetting power and branch fusing. The PPDA I/O pack is mounted on either the IS410JPDGH1A or IS410JPD SG1A.
- Prefabricated power cable harnesses interconnect PDMs and system control and I/O components

The Mark Vle control system can support two or more independent sources of power. A typical configuration uses two separate AC grid power feeds as primary sources to bulk control and wetting supplies. An optional secondary power source could be a plant's 24, 48, or 125 V dc station battery system, which is charged by the local AC grid. This configuration keeps the control system powered during loss of AC power events and (with station battery) can support black start operations. The Mark Vle approach provides flexible, field-proven redundancy schemes for the power sources, power supplies, and power cables to Simplex and Redundant I/O, eliminates custom engineered solutions, and assures proper responses to failures in power delivery. The application designer can select the appropriate system reliability and fault coverage.

The PDM configuration provides isolation between core control power and I/O wetting power, protecting controller and I/O electronics from power surges or dips received from noisy field I/O. The PDM's built-in coordinated circuit protection isolates faults within the system and prevents the spread of issues. Examples are in branch protection by fuses, which prevents a module short from taking down supplies up stream. This also protects wire insulation and connectors from exceeding safe temperatures.

The Power Distribution Module Specifications table provides specifications for the IS410JPDx PDMs available for use in the Mark Vle and Mark VleS control systems.

For information on applying the PDM product line in a Mark VleS Functional Safety control system, as well as information on power configuration architectures, redundancy, power supplies, and cable harnesses, refer to the document *Mark VleS Functional Safety Control Systems Power Distribution Modules (PDM) Application Guide for General Market (GEI-100861)*.

For additional details on each PDM and the PPDA I/O pack, refer to the chapter "PDM Power Distribution Modules" in the document *Mark VleS Functional Safety Systems for General Market Volume II: System Guide for General-purpose Applications (GEH-6855_Vol_II)*.

Power Distribution Module Specifications

Item	Power Distribution Module				
	IS410JPDGH1A	IS410JPDSG1A	IS410JPDEG1A	IS410JPDHG1A	IS410JPDDG#A
Product Name	Mark Vle Control & I/O Wetting Power Distribution	Mark Vle Control Power Distribution	Mark Vle I/O Wetting Power Distribution	Mark Vle High Density Control Power Distribution	Mark Vle I/O Wetting Power Branch Distribution
Life-cycle Status	Active	Active	Active	Active	Active
Redundancy Configurations	Single or Dual Diode OR'd supplies	Simplex, Dual, and TMR supplies	Single or Dual Diode OR'd supplies	Simplex, Dual, or TMR control power (R/S/T) distribution	Fused, switched I/O wetting power distribution
Power Monitoring I/O Pack	IS420PPDAH1B (order separately)	IS420PPDAH1B (order separately)	None; shares PPDA via ribbon cable to JPDS	—	—
28 V dc Control Power Inputs	Supports 2 externally Diode OR'd 28 V dc control power supplies, 40 A max	Supports 2 externally Diode OR'd 28 V dc control power supplies, 20 A max	—	28 V dc control power Inputs (J1), 13 A max	—
28 V dc Control Power Outputs	<ul style="list-style-type: none"> Qty 4 Control power fused bulk outputs, 7 A max Qty 4 Control power self-recovering, poly-fused outputs, 2.0 A max Qty 5 Control power self-recovering, poly-fused outputs, 0.8 A max 	<ul style="list-style-type: none"> Qty 6 Control power fused bulk outputs, 13 A max Qty 3 Control power un-fused Outputs, 3.0 A max Qty 3 Control power self-recovering, poly-fused outputs, 0.8 A max 	—	<ul style="list-style-type: none"> Qty 24 Control power self-recovering, poly-fused outputs, 0.8 A max (8 each via JR1-8, JS1-8, JT1-8) 	—
24/48 V dc I/O Wetting Power Inputs	Supports 2 externally Diode OR'd 24/48 V dc floating I/O wetting power supplies, 40 A max, with optional bias to provide ground fault detection	—	Supports 2 externally Diode OR'd 24/48 Vdc floating I/O wetting power supplies, 24 A max, with optional bias to provide ground fault detection; Supports externally Diode OR'd 24/48 V dc floating station battery, 30 A max	—	24/48 V dc contact wetting input (J28), 20 A max or 125 V dc contact wetting inputs (J125), 10 A max
24/48 V dc I/O Wetting Power Outputs	Qty 7 I/O wetting fused bulk outputs, 10 A max	—	Qty 3 I/O wetting fused no switch bulk outputs, 10 A max. Qty 3 I/O wetting fused & switched bulk outputs, 5 A max	—	Qty 6 I/O wetting branch circuits fused, switched outputs (JD1-JD6), 7 A continuous max
User-supplied I/O Wetting Power Fuses (for JPDD)	—	—	—	—	Max fuse rating 250 V dc at 15 A. For application flexibility, fuses are provided by user. IS410JPDDG2A supports 5 x 20 mm (0.20 x 0.79 in) fuses. IS410JPDDG3A supports 6.35 x 31.75 mm (0.25 x 1.25 in) fuses.
Cable Harnesses/PDM Interconnections	For cable harnesses, descriptions, and part numbers, refer to the chapter "Standard Cable Harnesses for PDMs" in the document <i>Mark VleS Functional Safety Control Systems Power Distribution Modules (PDM) Application Guide for General Market (GEI-100861)</i> .				
Monitors Power Supply Health Contacts	Yes, up to 4 power supplies	Yes, up to 3 power supplies	Yes, up to 2 power supplies	—	—
Health and Status LEDs	PPDA self-checking, monitors 2 AC mains, power supplies, I/O wetting power ground fault, and glass/ceramic fuses, reports health to controller via IONet	PPDA self-checking, monitors power supplies, reports health to controller via IONet	Reports ceramic fuse faults, I/O wetting supply ground fault, and I/O wetting power diagnostics to JPDS via 50-pin ribbon cable, J1 to J2	—	28 V dc nominal, at 0.24 A
PPDA Input Power	28 V dc nominal, at 0.24 A	28 V dc nominal, at 0.24 A	—	—	—

Power Distribution Module Specifications (continued)

Item	Power Distribution Module				
	IS410JPDGH1A	IS410JPDSG1A	IS410JPDEG1A	IS410JPDHG1A	IS410JPDDG#A
PPDA Control Power cable to JPDG/JPDS	336A4937RDG010, 10" cable, PPDA to JPDG JD4 (order separately)	336A4937RDG010, 10" cable, PPDA to JPDS P4 (order separately)	—	—	—
Module Dimensions (includes cover and I/O Pack) (H x W x D)	17.0 x 23.1 x 15.2 cm (6.7 x 9.1 x 6.0 in)	17.0 x 23.1 x 15.2 cm (6.7 x 9.1 x 6.0 in)	17.0 x 22.1 x 11.4 cm (6.7 x 8.7 x 4.5 in)	16.5 x 15.2 x 11.4 cm (6.5 x 6.0 x 4.5 in)	24.1 x 15.2 x 11.4 cm (9.5 x 6.0 x 4.5 in)
Mounting	DIN-rail mounted				
Cooling	Convection				
Safety Rated	Non-interfering				
Hazardous Locations Capability	Class 1, Div 2 / Class 1, Zone 2 / ATEX. For ratings and further details, refer to the document <i>Mark VleS Functional Safety System Equipment in Hazardous Locations (HazLoc) Instruction Guide (GEH-6861)</i> .				
G3 Compliant	Yes				
Ambient Operational Temperature	-40 to 70°C (-40 to 158°F)				
Storage Temperature	-40 to 85°C (-40 to 185°F)				
Humidity	95% non-condensing				
Module Replacement Part Number	IS410JPDGH1A	IS410JPDSG1A	IS410JPDEG1A	IS410JPDHG1A	IS410JPDDG2A, with 5 x 20 mm (0.20 x 0.79 in) style fuse holders IS410JPDDG3A, with 6.35 x 31.75 mm (0.25 x 1.25 in) style fuse holders
Module Cover Replacement Part Number	151X1202YE12PP02BL	151X1202YE12PP02BL	151X1202YE12PP01BL	151X1202YE12PP03BL	IS410JPDDG2A: 151X1202YE12PP04BL IS410JPDDG3A: 151X1202YE12PP04BL

Codes, Standards and Environment

Industry Codes and Standards

IEC 61508 : 2010 Parts 1-7

EN50402:2005+A1:2008 Logic Solver

CAN/CSA-C22.2 No. 61010-1-12

UL Std. No. 61010-1 (3rd Edition)

EN 61010-1 (3rd edition)

Achilles Level 1 certification, controller security



Temperature Considerations

Mark VleS electronics can be I/O packaged in a variety of different configurations and designed for different environmental conditions. Proper thermal considerations for active electronics with heat sensitive components must be considered for electronics I/O packaging. For internal enclosed design considerations, all components have an ambient temperature rating of -30 to 65°C (-22 to 149°F). The allowable temperature change without condensation is $\pm 15^{\circ}\text{C}$ (59°F) per hour. It is recommended that the environment be maintained at levels less than the maximum rating of the equipment to maximize product life expectancy.

I/O packaging the equipment and selecting an appropriate enclosure to maintain the desired temperature is a function of the following:

- Internal heat dissipation from the assemblies
- Outside ambient temperature
- Cooling system (if used)

Humidity

The ambient humidity range is 5 to 95% non-condensing. This exceeds EN50178.

Elevation

Equipment elevation is related to the equivalent ambient air pressure:

- Normal operation: 0 to 1000 m (0 to 3280.8 ft, 101.3 to 89.8 kPa)
- Extended operation: 1000 to 3050 m (3280.8 to 10006.5 ft, 89.8 to 69.7 kPa)
- Shipping: 4600 m (15091.8 ft, 57.2 kPa) maximum

Software Tools

There are several Microsoft® Windows® based software tools associated with the Mark VleS system. A summary of the more frequently used applications is provided below.



The ToolboxST* application features include:

- System component (controllers, I/O packs, WorkstationST*) layout and configuration
- Configure, edit, and view real-time controller application code
- Ethernet Global Data (EGD) editor
- Component diagnostics
- Password protection



The WorkstationST OPC®-DA server provides a common interface between the safety system and other control systems. The OPC-DA server conforms to the 2.0 data access standards. The OPC standard defines two software roles, OPC clients and OPC servers. In general, clients are consumers of automation information and servers are producers of the same information.

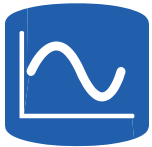

The Trender application is used to capture both real-time and historical data for display in graphical form. Several forms of data collection are supported for a wide range of resolution. Trigger configured data collections are also supported.



The Control System Health (CSH) system collects diagnostic data on various hardware/software components and makes it available in a combination of three ways:

- Control System Health Viewer application where the user can navigate to a component or critical application and view health status
- Alarm Viewer application includes a complete set of control system component diagnostic alarms in addition to the process alarms
- Alarm Viewer application includes a complete set of control system component diagnostic alarms



The Alarm Viewer application displays and manages live and historical alarm and event information. Alarm and event information is displayed in tabular form with advanced filtering and sorting capabilities. Common functions provided around the process alarms/events include:

- Acknowledging Alarms
- Locking Alarms
- Silencing Alarms
- Sequence of Events (SOE)
- Component Diagnostic Alarms

Example Burner Management System

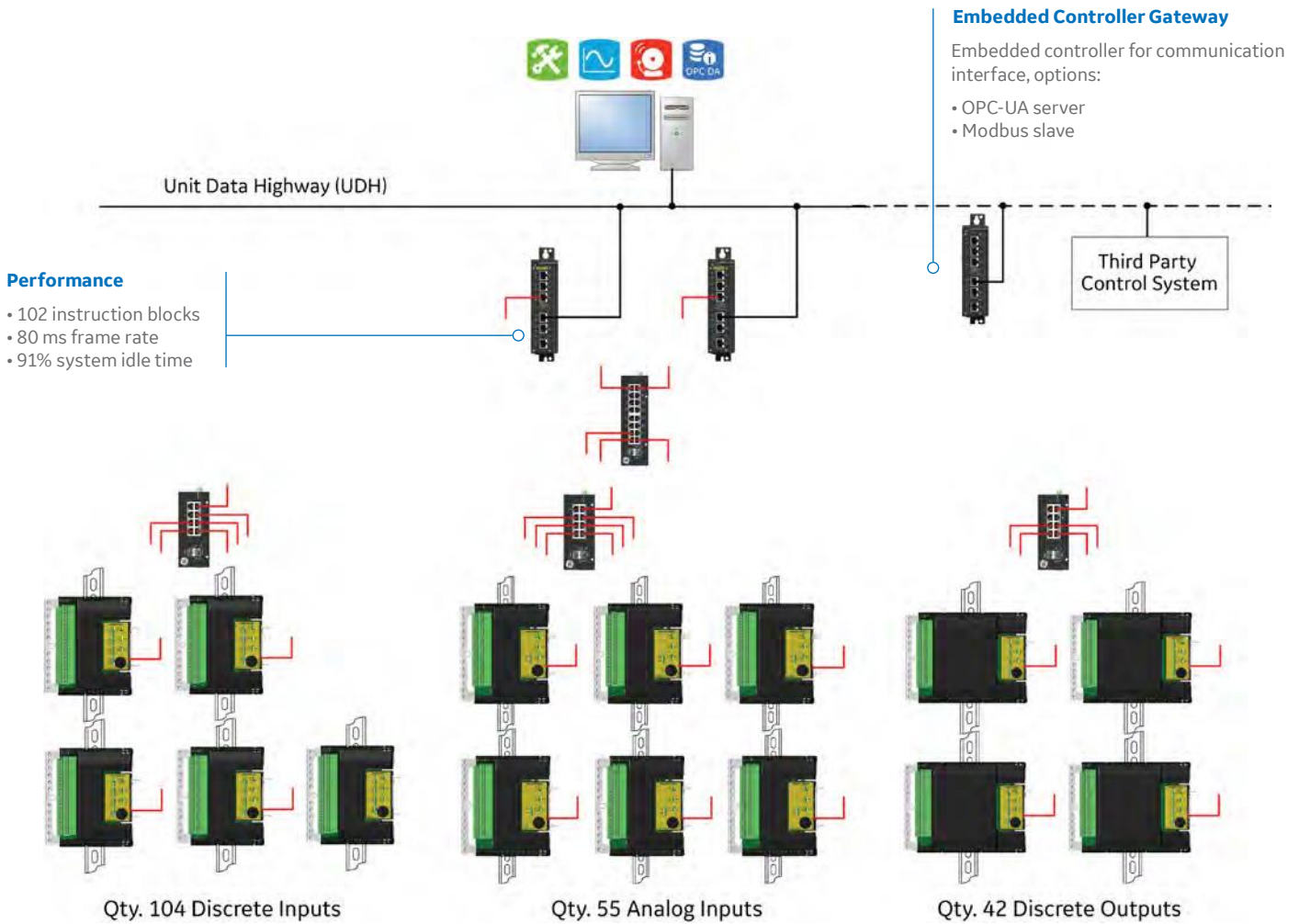

Mark VleS Bill of Material

Cat No	Qty	Item
IS420UCSBS1A	2	Mark VleS Controller
IS230SCISH1A	5	Discrete Input Module – 24 VDC
IS230SAISH1A	6	Analog I/O Module
IS230SRLSH1A	4	Contact Output Module
IS420ESWAH3A	3	IONet Switch – 8 port
IS420ESWBH3A	1	IONet Switch –16 port

Notes

- 28 VDC power for I/O packs and controller require Micro MATE-N-Lok receptacle (AMP 1445022-3)
- IONet cabling (CAT5 E-Net cables) identified in red.
- Third-party control system interfaces supported include:
 - OPC-DA server via WorkstationST
 - OPC-UA server via WorkstationST
 - Modbus master via WorkstationST
 - Modbus master via embedded controller



2012

