



ABB ELECTRIFICATION – DISTRIBUTION SOLUTIONS, MAY 2020

DC Traction Power Supply

Value propositions

René Jenni / Product Line DC Traction Power Supply
Antonio Colla / Global Railway Marketing & Sales Manager



Agenda

Value propositions

Product and solution offerings

Main References



DC Traction Power Supply

Value propositions

DC Traction Power Supply

Value propositions

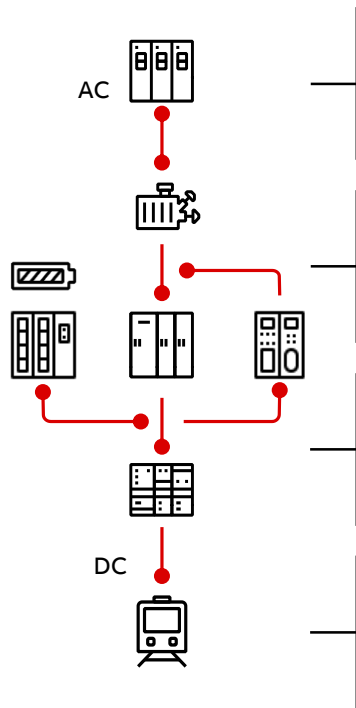

1 Primary and secondary medium voltage switchgear



2 Transformer-rectifier groups, traction controlled rectifiers



3 DC HSCB, DC switchgear & voltage limiting devices



4 Energy recuperation & energy storage systems



A comprehensive product portfolio combined with an extensive application know-how

DC Traction Power Supply

Value propositions

Factory-assembled solutions

DC eHouse

- Prefabricated walk-in modular outdoor enclosures in steel, concrete or glass reinforced polyester.
- Factory assembled and tested solutions ensure that site works run faster and smoothly.







DC Traction Power Supply

Value propositions

Electrification packages

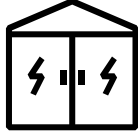
- Comprehensive ABB portfolio covering all functional requirements of DC traction substations.
- Reduced contracting time.
- One contract and one single point of contact.

	 Electrical Equipment	 Energy Management	 Complete DC eHouse	 Installation	 Maintenance agreement
Basic Package	•			•	•
Extended Package	•	•		•	•
Full Package	•	•	•	•	•
DC eHouse			•	•	•

DC Traction Power Supply

Rectifier substations

- Medium voltage switchgear
- Diode rectifiers and controlled rectifiers
- DC high-speed circuit breakers
- DC switchgear
- Protective devices
- Energy recuperation and energy storage systems

DC Traction Power Supply

Rectifier substations – Main electrical equipment

DC feeding scheme

- DC traction power supply networks consist normally of an MV grid, which supplies the DC injection points along the railway line.
- Medium voltage equipment are standard gas- or air-insulated three-phase switchgear.
- Rectifiers convert the 3-phase supply voltage to DC voltage.
- More sophisticated systems allow feeding back surplus energy into the MV grid.
- DC switchgear and voltage limiting devices serve as control and protection equipment.
- Energy storage systems are used for peak shaving and voltage stabilization in traction systems.

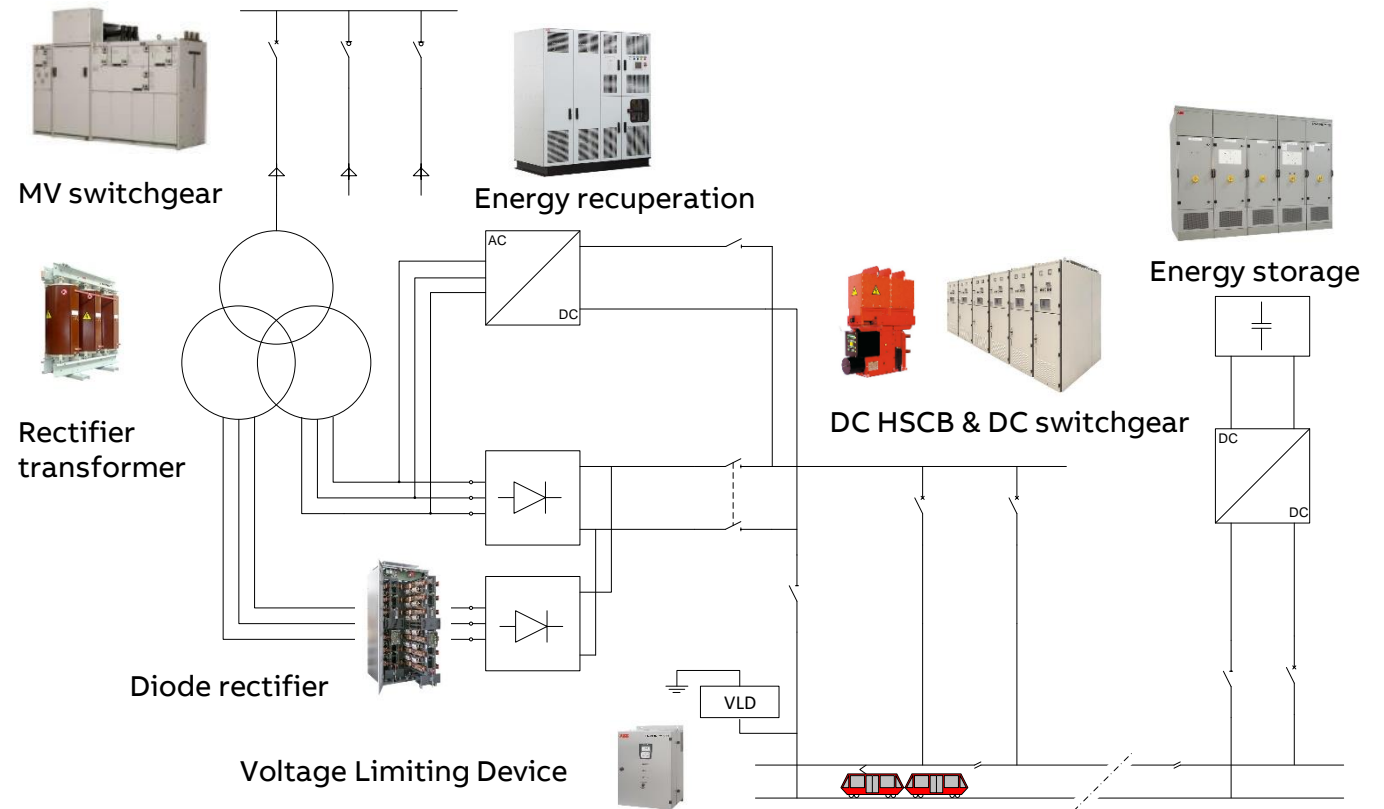

DC Traction Power Supply

Rectifier substations – Main electrical equipment

Rectifiers

- DC traction power supply networks consist normally of an MV grid, which supplies the DC injection points along the railway line.
- Medium voltage equipment are standard gas- or air-insulated three-phase switchgear.
- **Rectifiers convert the 3-phase supply voltage to DC voltage.**
- More sophisticated systems allow feeding back surplus energy into the MV grid.
- DC switchgear and voltage limiting devices serve as control and protection equipment.
- Energy storage systems are used for peak shaving and voltage stabilization in traction systems.

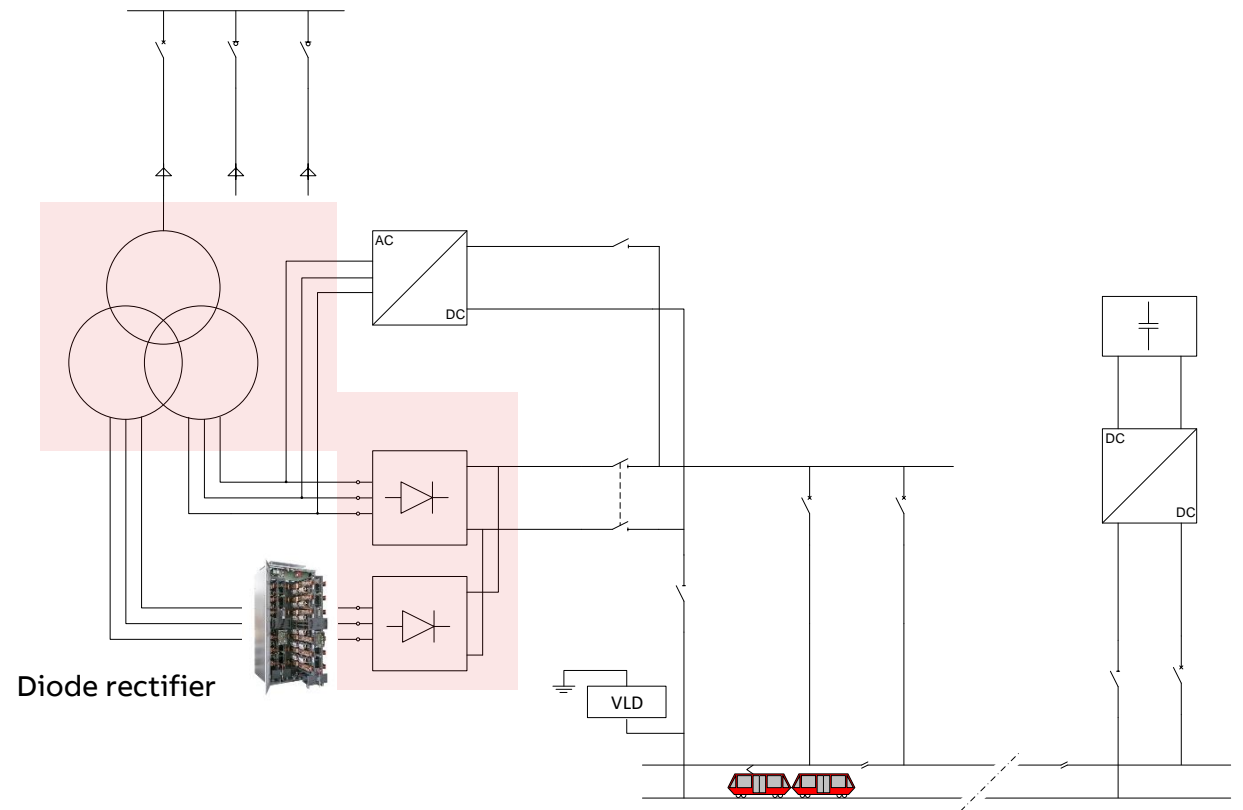

DC Traction Power Supply

Rectifiers

Transformer-rectifier groups

ABB offers a full range of rectifiers in line with EN 50328 and IEC 62590 connection schemes.

- No 8 Six pulse rectifier
- No 9 Twelve pulse rectifier with two six pulse bridges connected in parallel (with or without interphase transformer)
- No 12 Twelve pulse rectifier with two six pulse bridges connected in series

	Transformer connection		Converter connection
	Line side	Valve side	
8			
9			
12			

DC Traction Power Supply

Rectifiers

Diode rectifier Enviline TDR / WDR

ABB provides a comprehensive range of rectifier transformers and diode rectifiers in different technologies, configurations and ratings.

Key benefits:

- Fixed and withdrawable solutions
- High availability
- Flexible footprint

Main ratings:

- Up to 5 MW @ 750 VDC and 8 MW @ 1500 / 3000 VDC
- Duty class according to EN 50328 and IEC 62590
- 6, 12 or 24 pulse solutions
- Natural convection cooling



DC Traction Power Supply

Rectifiers

Controlled rectifier Enviline TCR

Enviline TCR ¹⁾ is a controlled rectifier. The DC voltage control allows longer distances between substations, reduces losses and can prevent interruptions caused by under-voltage.

Key benefits:

- DC line voltage control
- Proven and robust thyristor technology
- High overload capability

Main ratings:

- Up to 5 MW @ 750 VDC and 8 MW @ 1500 / 3000 VDC
- Duty class according to EN 50328 and IEC 62590
- 6, 12 or 24 pulse solutions
- Natural convection cooling or forced cooling



DC Traction Power Supply

Rectifier substations – Main electrical equipment

DC HSCB and DC Switchgear

- DC traction power supply networks consist normally of an MV grid, which supplies the DC injection points along the railway line.
- Medium voltage equipment are standard gas- or air-insulated three-phase switchgear.
- Rectifiers convert the 3-phase supply voltage to DC voltage.
- More sophisticated systems allow feeding back surplus energy into the MV grid.
- **DC switchgear and voltage limiting devices serve as control and protection equipment.**
- Energy storage systems are used for peak shaving and voltage stabilization in traction systems.

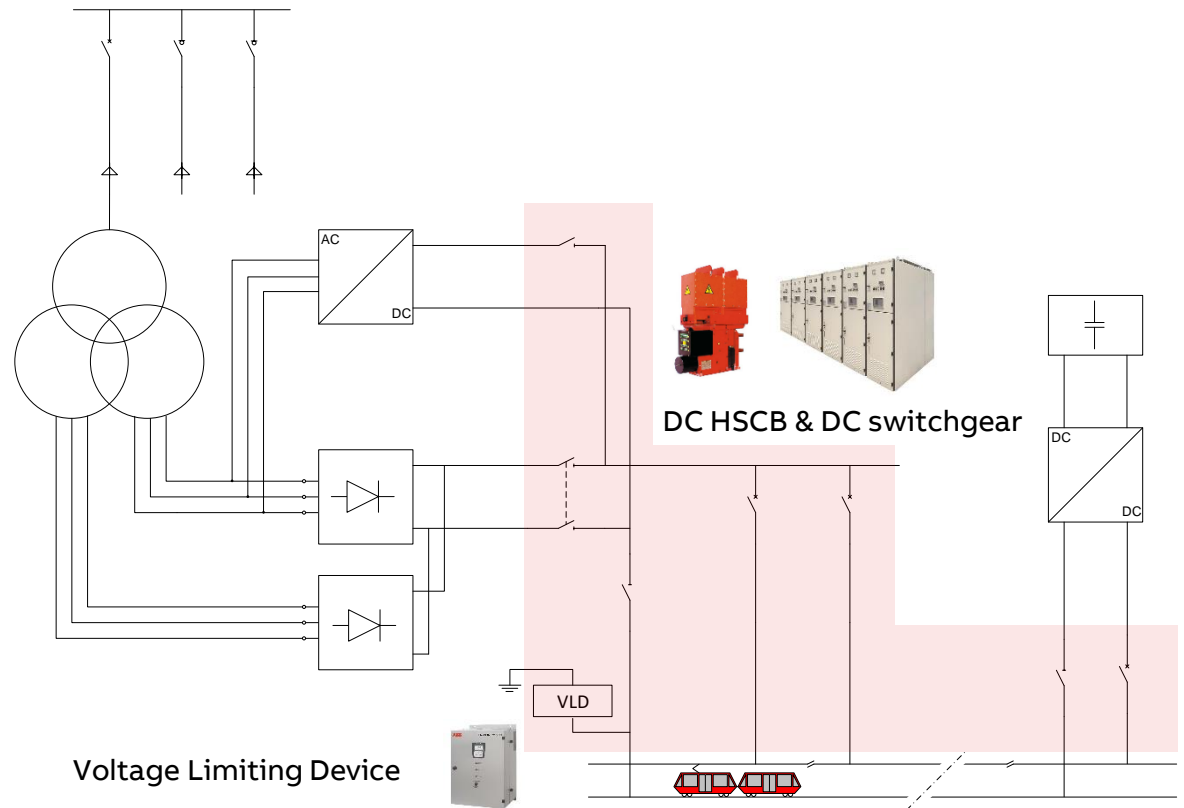

DC HSCB Gerapid and DC switchgear Enviline DCGear

Together we drive progress

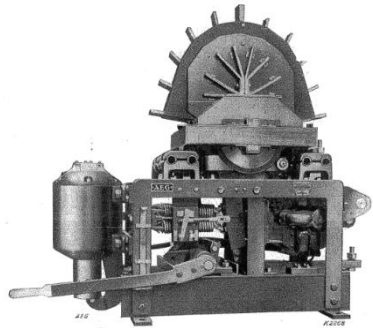

**AEG DC Circuit Breaker
ca. 1926**

Rated 2500 A, 1650 V DC

Acquisition of GE Industrial Solutions

Legacy

In July 2018, ABB closed the acquisition of General Electric Industrial Solutions.

ABB has now strengthened its position in the urban transport market and gained experience in the design and manufacture of DC high-speed circuit breakers and DC switchgear.

Market

Gerapid product line was launched by GE and AEG Germany in 1998.

Today, over 20'000 Gerapid circuit breakers have been sold and installed in more than 40 countries worldwide.



**ABB DC HSCB Gerapid and
DC switchgear Enviline DCGear**

DC HSCB Gerapid

Functionality and performance range

Product

- Gerapid DC high-speed circuit breakers are single-pole circuit breakers designed for use in DC traction power substations.

Range

- ABB is covering all applications and ratings with its DC HSCB Gerapid.
- DC HSCB Gerapid are available with thermal currents up to 8000 A and rated voltages of 900, 1800 and 3600 V.
- Reference standards: EN50123-2 and IEC61992-2.
- Also available according to IEEE (ANSI) C37.14.



DC HSCB Gerapid

Key features



Enclosed construction

Isolated & enclosed construction ensures highest safety against flashover faults.



High ratings

EN 50123-2 / IEC 61992-2 breaking capacity of 125 kA /178 kA in peak at 900 V and Tnc=100 ms.



Unique & proven design

Mechanical latching mechanism providing stable contacts force and does not require any holding circuits.
Double contact system eliminates maintenance of main contacts.



Simplified solutions

Gerapid without control cards is available for cost effectiveness.



Ease of use & service

Same footprint up to 6 000 A and embedded control circuits makes it cost effective & easy for integration.



Retrofit solutions

Withdrawable retrofits for AEG's GEA Rapid SE power DC breakers (GEA SE).

DC HSCB Gerapid

Insight view

Arc Chute

Compact size, asbestos free, cold-cathode splitter plate system with high energy dissipation capacity.

Control Box

Control cards and auxiliary contacts for signaling and safety functions.

Closing Solenoid

Instant closing with mechanical position indicator.



Main Terminals

Vertically or horizontally oriented, depending on applications and ratings.

Enclosed Frame

Mitigates hazards of arc flash & hot gasses exhaust. Improved insulation.

Arcing Contact

Copper piece that protects main contacts against arcing.

Main Mechanism

Modular mechanism with main spring enclosed.

Provides mechanical latching and stable contact force.

No holding circuit needed.

Auxiliary Release

Zero voltage or shunt trip releases for remote tripping.

ED Impulse Release

Remotely controlled high speed coil. Supplied from a capacitor bank.

Main fixed contact

Copper bus carrying main current. Connected to the top and bottom terminal.

Overcurrent direct trip release

Instantaneous magnetic release. Bidirectional & direct acting. Adjustable or fixed thresholds from 1,5 kA to 24 kA.

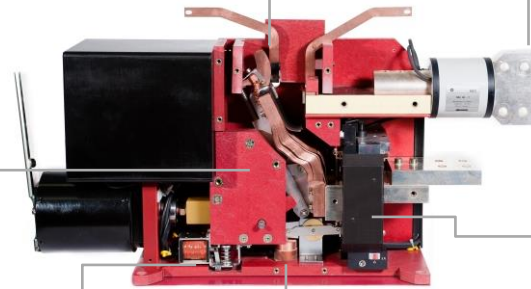

DC Switchgear Enviline DCGear

Functionality and performance range

Product

- Enviline DCGear serves as control and protection equipment in DC traction power distribution networks.
- The cubicles contain proven technology components, such as ABB's DC HSCB Gerapid.

Range

- Enviline DCGear for railway applications are available with service currents up to 7000 A ¹⁾ and rated voltages of 900, 1800 and 3600 V.
- Reference standards: EN50123 and IEC61992.



DC Switchgear Enviline DCGear

Key features



Enclosed construction

Designed for railway applications in a harsh environment. Freestanding rigid metal enclosed cubicle with separate screened compartments.



Full spectrum

Large range of ratings and variants of panels.



Proven design

Tested as per standards EN 50123, EN 60068 and IEC 61992.

Use of proven technology components, such as ABB's DC HSCB Gerapid.



Low maintenance

High availability and low maintenance. Minimum wear-and-tear of main contacts of the DC HSCB Gerapid.



Flexibility

Flexible footprint and variety of panels in different configurations for various applications.



Safety

High active and passive safety for operation and maintenance personnel.

DC Switchgear Enviline DCGear

Insight view

Construction

Free standing non-welded structure. Fully segregated compartments.

Rear compartment

Comprising main busbar and bypass busbar, disconnectors, current, voltage measuring and other devices.

Circuit-breaker compartment

DC HSCB mounted on a trolley.

Main insulating bushings between rear and circuit breaker compartment providing full protection against flash-over.

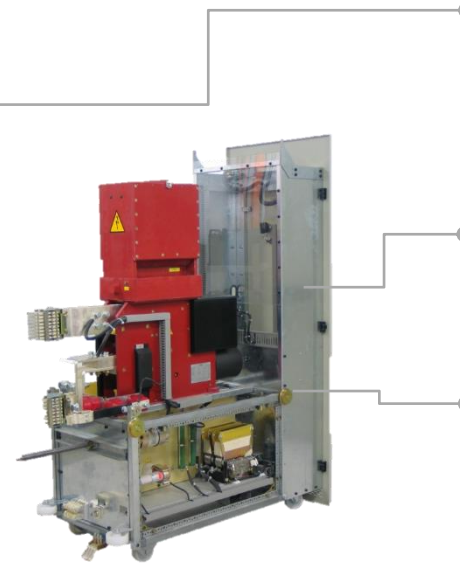

Low voltage compartment

Combined protection and control relay with HMI and other components to realize control and signaling circuits.

Circuit breaker trolley

Four wheeled trolley with DC HSCB Gerapid and line test device.

Guiding wheels (independent from basic wheels) for smooth operation. No need for any floor reinforcing.

Options

Motorized circuit breaker trolley.

Additional side panels for cable disconnecter switches.

Protective Devices

Protection & control

Distribution automation

All-in-one user interface, automation platform and gateway designed for IEC 61850-based substation automation communication.

- Smart solutions for DC traction and auxiliary substations.
- User interface, communication gateway and automation platform in a single unit.
- Web based HMI provides a simple user interface for device control and management with multiple user access.

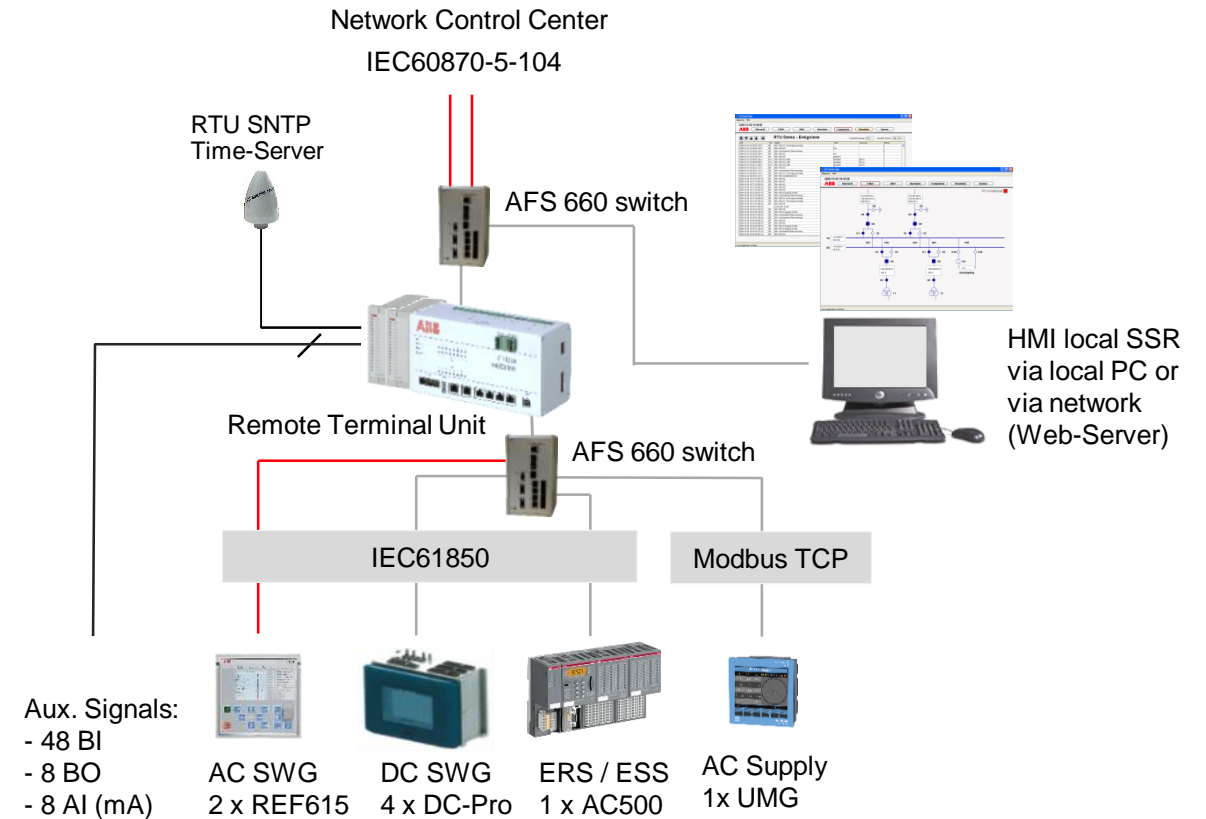

Protective Devices

Voltage limiting devices

Enviline VLD and HVL

- Voltage limiting devices (VLDs) are used to ensure personal protection.
- VLDs are connected between earthed system parts and the track, monitoring the potential difference at their terminals.
- If limit values are exceeded, a temporary equipotential bonding is preventing the tapping of impermissible touch voltages by people in case a fault occurs or during operation.

Enviline VLD

Class 4 - Combination of thyristor and contactor



HVL

Class 2 - Thyristor triggering

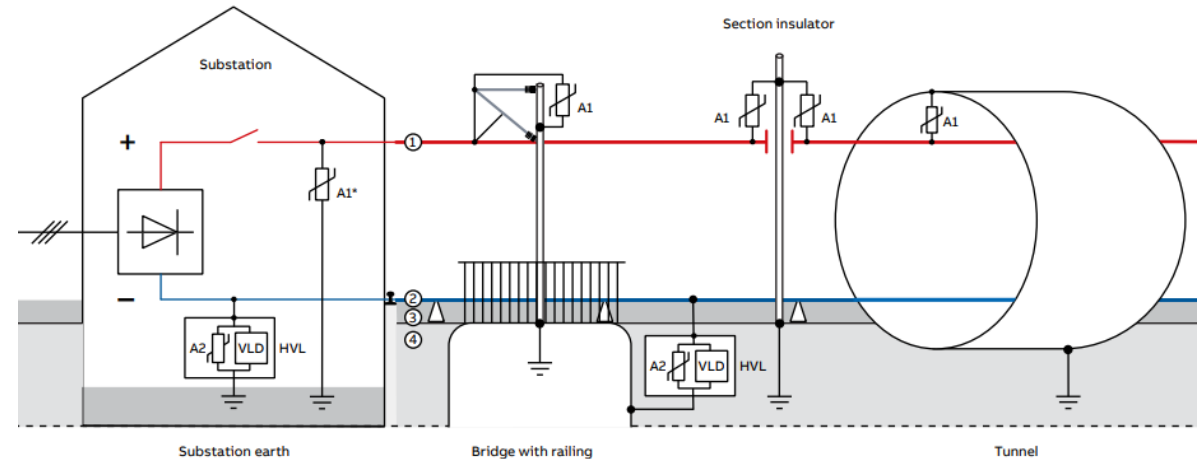

DC Traction Power Supply

Rectifier substations – Main electrical equipment

Energy management solutions

- DC traction power supply networks consist normally of an MV grid, which supplies the DC injection points along the railway line.
- Medium voltage equipment are standard gas- or air-insulated three-phase switchgear.
- Rectifiers convert the 3-phase supply voltage to DC voltage.
- **More sophisticated systems allow feeding back surplus energy into the MV grid.**
- DC switchgear and voltage limiting devices serve as control and protection equipment.
- **Energy storage systems are used for peak shaving and voltage stabilization in traction systems.**

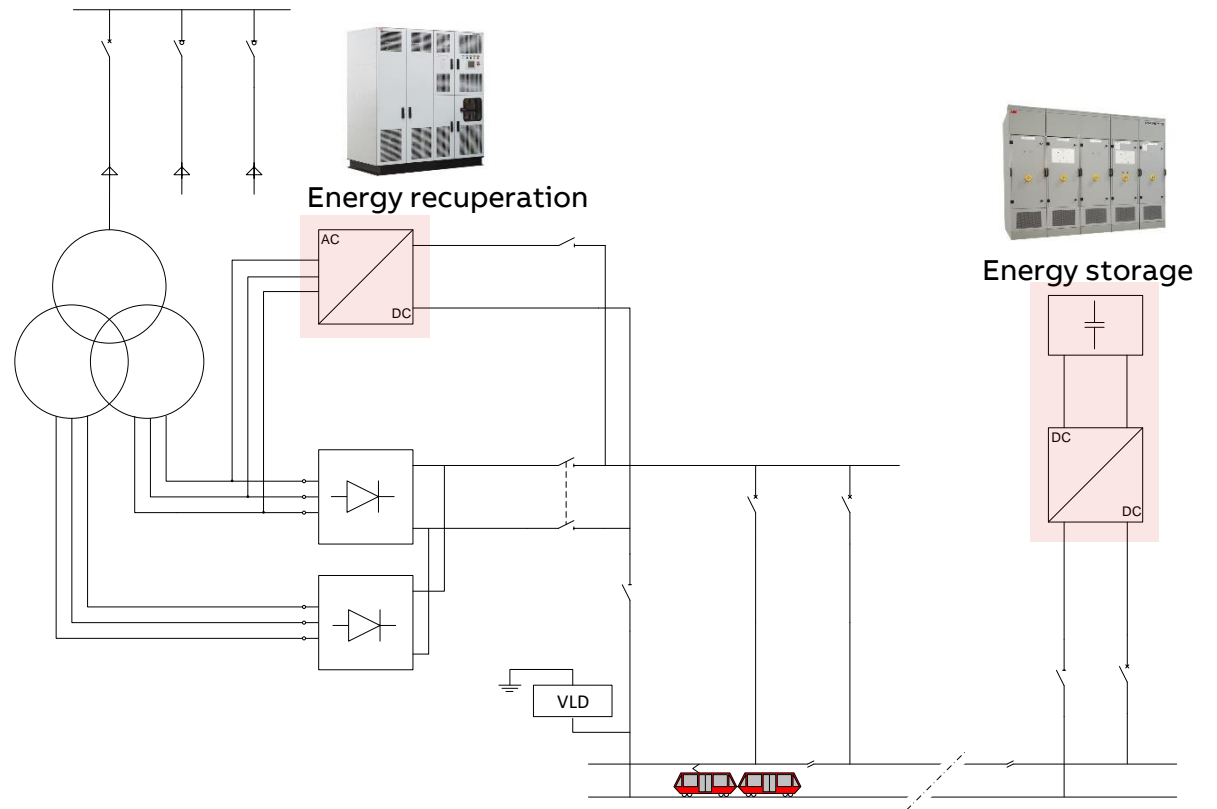

DC Traction Power Supply

Energy management solutions

Regenerative braking

- Electric rail transit operators are amongst the largest consumers of electricity.
- Recycling the braking energy is the single largest opportunity to improve the energy efficiency.
- ABB offers a complete range of smart energy management solutions.

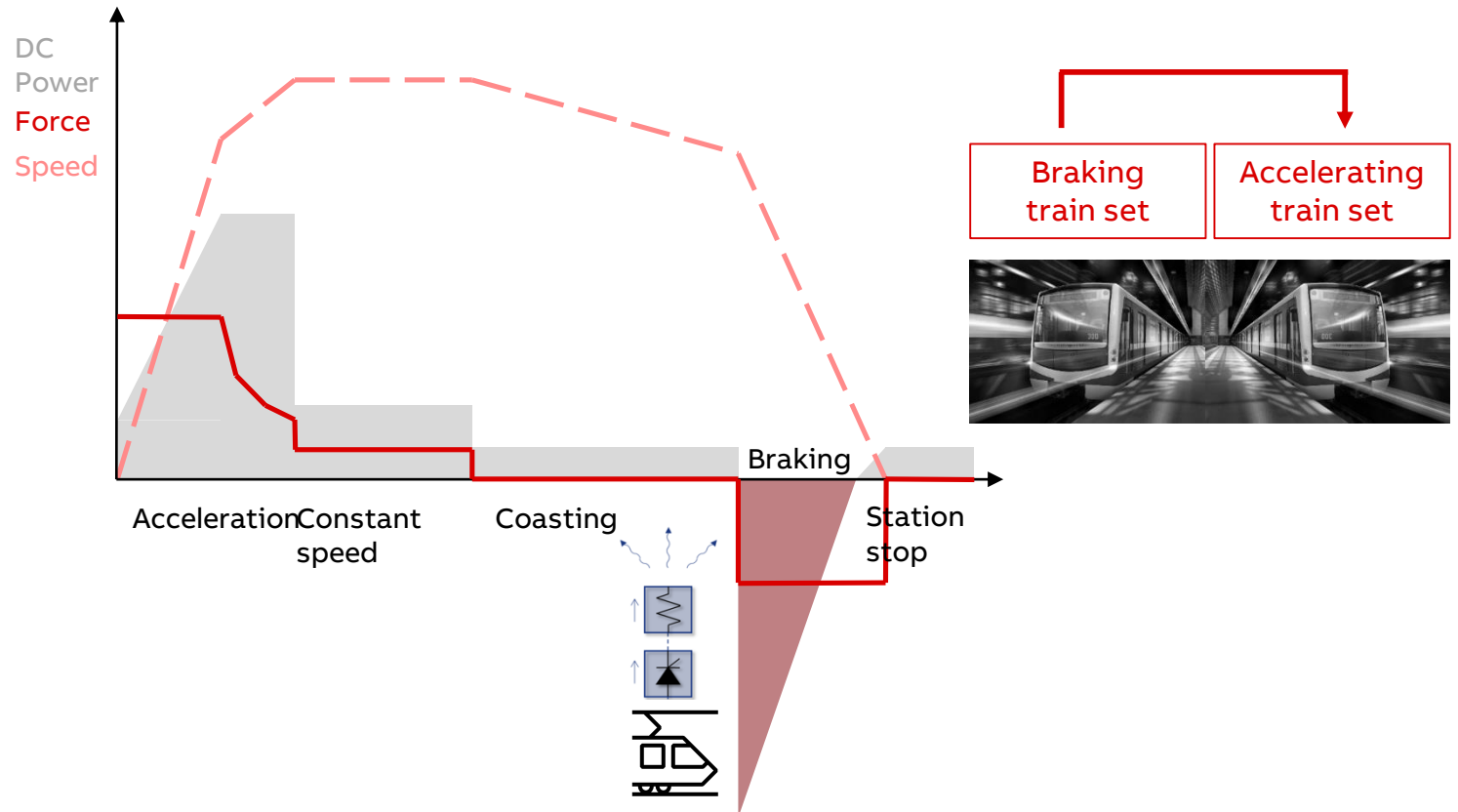

DC Traction Power Supply

Energy management solutions – Energy recuperation

Recovering the surplus braking energy

- Excess braking energy is fed back into the AC grid to supply own loads of the metro system, homes and businesses in the region.
- The railway becomes a net generator of electricity.

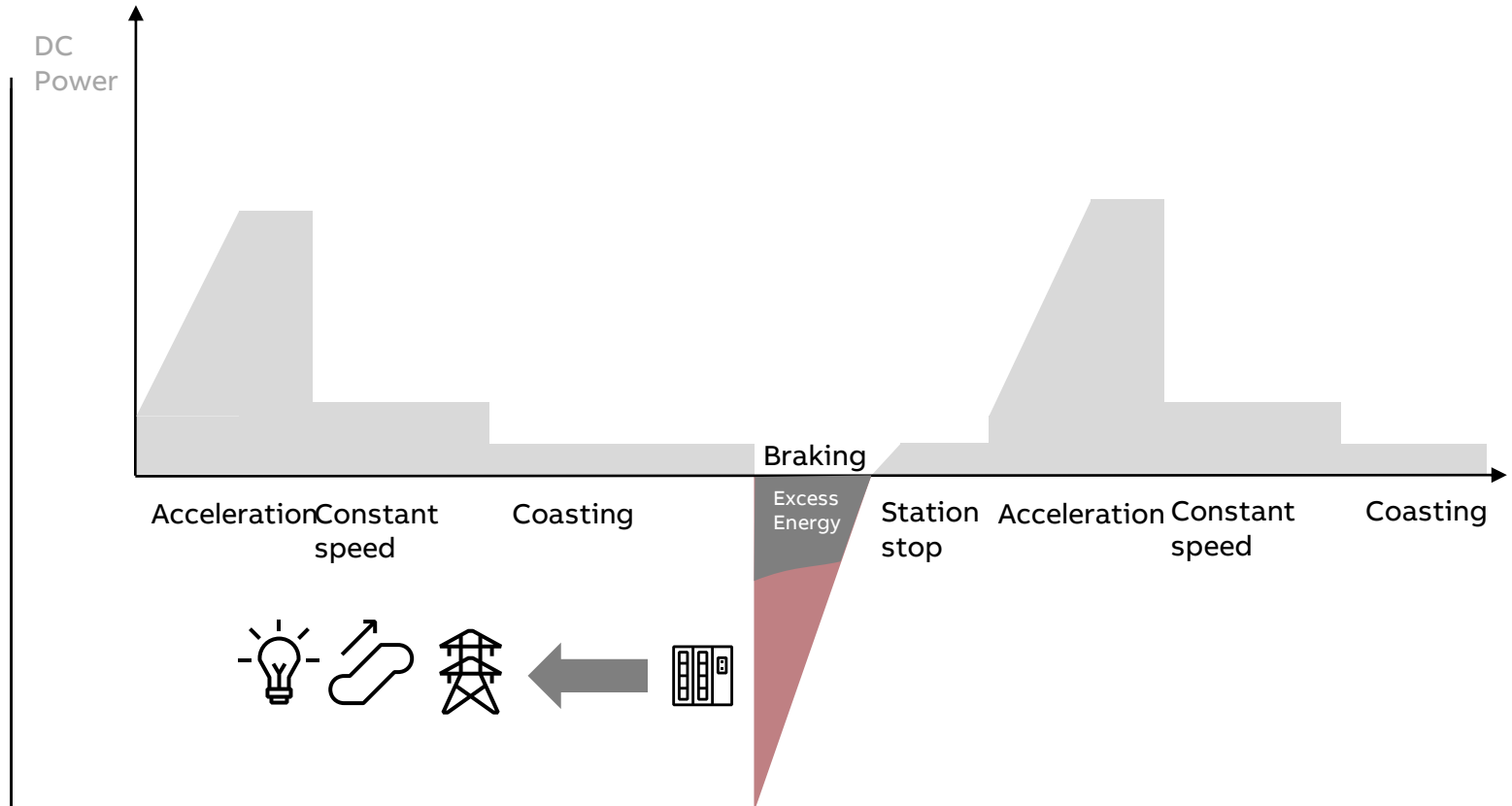

DC Traction Power Supply

Energy management solutions – Energy storage

Recycling the surplus braking energy

- A wayside energy storage system is capturing and storing the surplus braking energy. The stored energy is re-injected in the DC grid.
- A static energy storage systems provides substantial savings considering that it can repeat such cycle hundreds or even thousands of times each day.

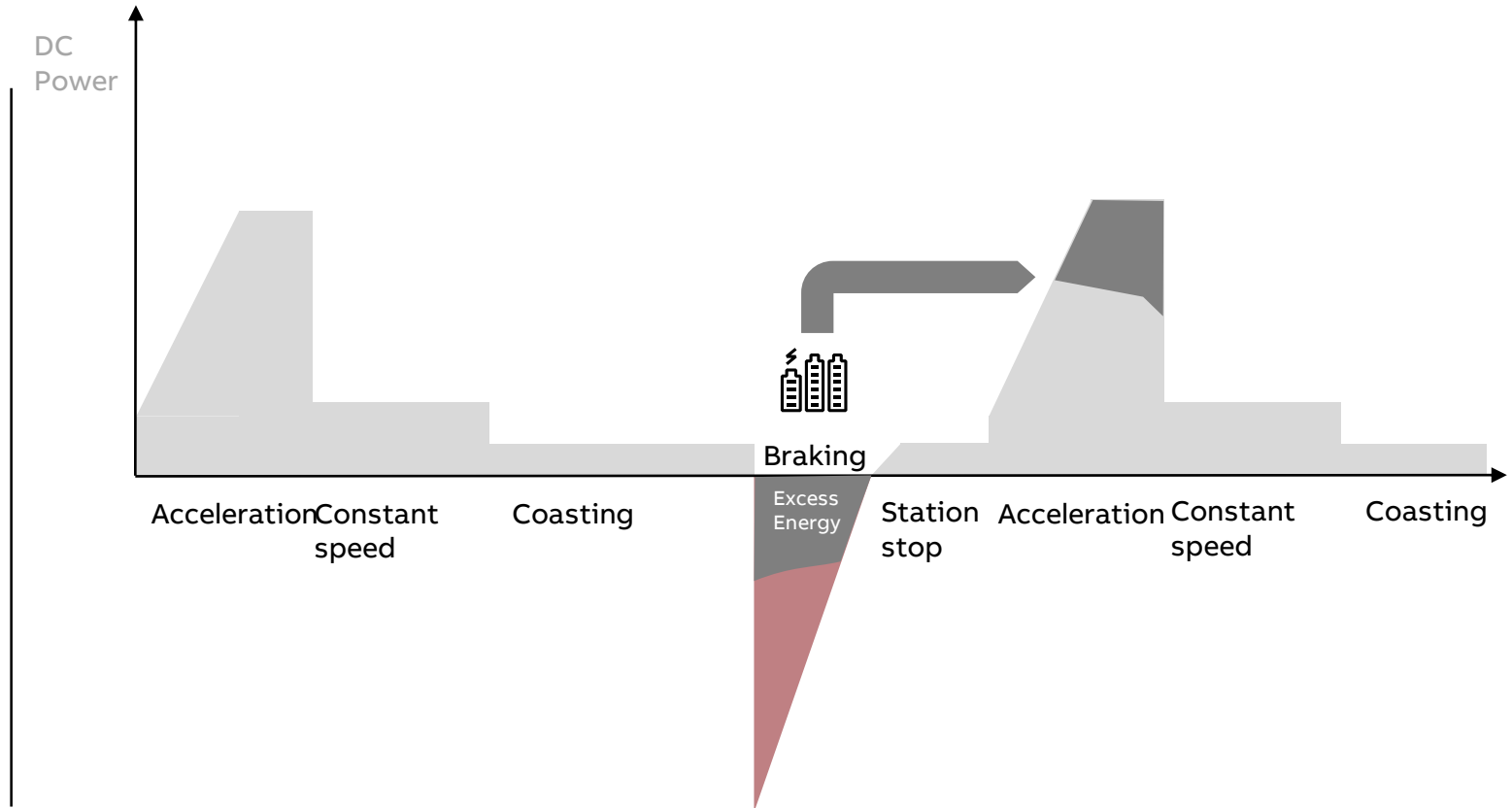

DC Traction Power Supply

Energy recuperation system

Enviline ERS – Increasing energy efficiency

Key benefits:

- Lowers energy costs through energy recuperation.
- Lowest upfront and maintenance costs.
- Reactive power compensation.
- Small footprint, easy installation and low maintenance.

Main ratings:

- 750 VDC: peak power up to 2.25 MW, continuous power up to 1 MW
- 1500 VDC: peak power up to 4.5 MW, continuous power up to 2 MW

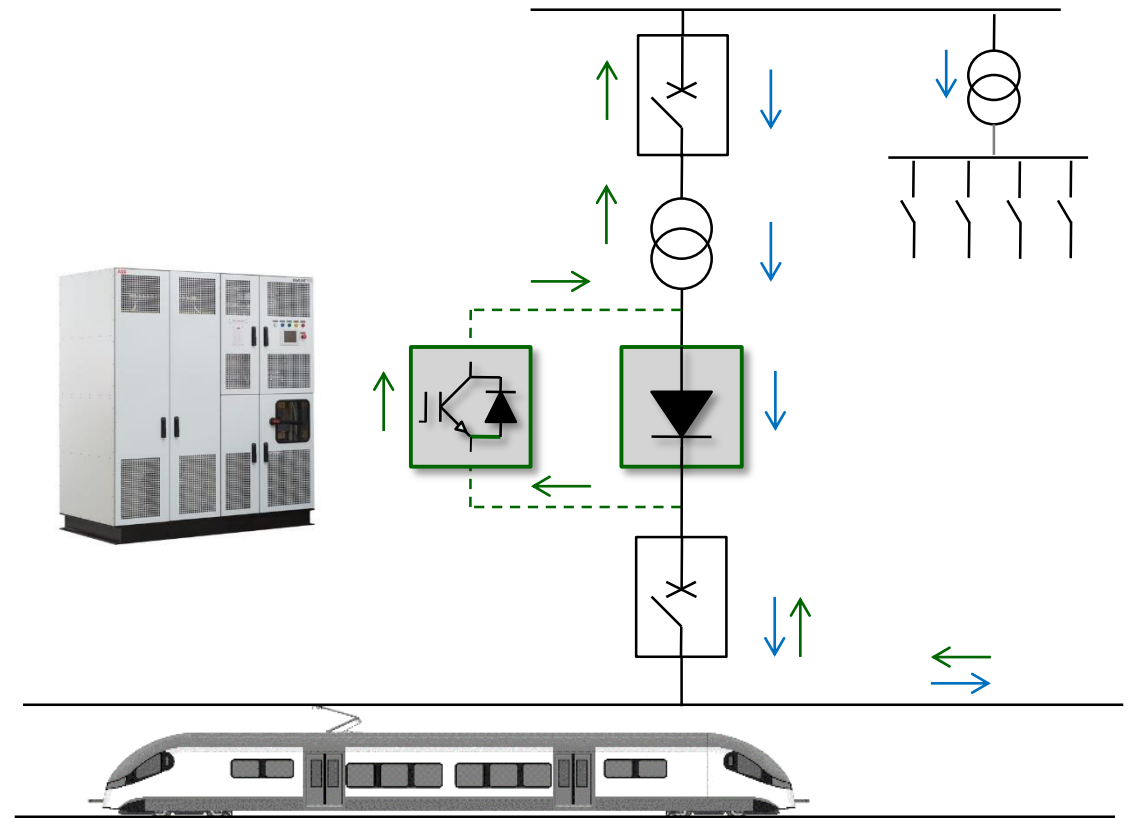

DC Traction Power Supply

Energy storage system

Enviline ESS – Increasing energy efficiency

Key benefits:

- Lowers energy costs through energy recovery.
- Reduces the demand charge and peak power penalties by cutting the starting power of trains.
- Supports grid voltage, avoiding inadmissible voltage drops.
- It can be provided with supercapacitors, batteries or a combination of both.

Main ratings:

- System rated power¹ up to:
 - 3.2 MW @ 750 VDC
 - 5.2 MW @ 1500 VDC

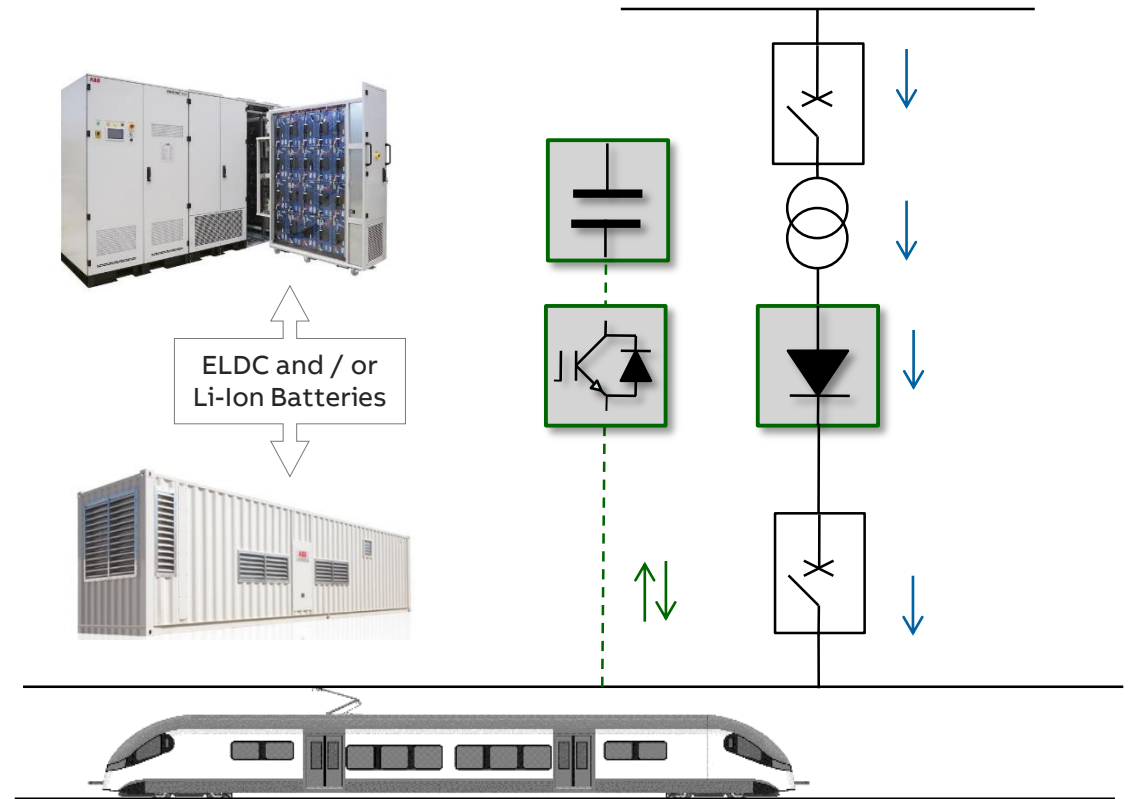



DC Traction Power Supply

Selected references

DC Traction Power Supply

Light Rail Application

GVB Amsterdam, Netherlands

Customer's need

- Vittal as main EPC requesting a new DC traction substation for the tramway line in Amsterdam.

ABB's response

- Comprehensive package for a new DC traction substations feeding the overhead lines with 750 VDC comprising:
 - Medium voltage switchgear UniSec
 - Rectifier transformers and diode rectifiers Enviline TDR
 - DC switchgear Enviline DCGear including protection and control
 - Substation automation system

Customer's benefits

- Complete electrification package out of one hand with high-tech and high quality Power Products, utilizing ABB's long standing experience in DC traction power supply applications.



DC Traction Power Supply

Tram-Train Application

Hódmezővásárhely Tram-Train, Hungary

Customer's need

- Strabag as main EPC requesting a new DC traction substation for the extension of the tram-train line in Hódmezővásárhely.

ABB's response

- Complete package covering design, supply and commissioning of a complete DC traction power supply package feeding the overhead line with 750 VDC. The scope comprises:
 - Medium voltage switchgear UniSec
 - Rectifier transformers, diode rectifiers Enviline TDR
 - DC switchgear Enviline DCGear and VLD

Customer's benefits

- Complete electrification package out of one hand with high-tech and high quality Power Products, utilizing ABB's long standing experience in DC traction power supply applications.



DC Traction Power Supply

Monorail Application

Liuzhou Monorail, China

Customer's need

- Zhuhai Dalong Electrical Equipment Co Ltd looking for a competitive supplier of main electrical equipment for a new monorail system built in Liuzhou.

ABB's response

- Design, supply and commissioning of the following main equipment for DC traction substations.
 - Gas insulated medium voltage switchgear ZX2
 - DC switchgear and VLD type Enviline DCGear

Customer's benefits

- Electrification package with high-tech and high quality products and services, utilizing ABB's long standing experience in serving the Chinese mass transit market.



DC Traction Power Supply

Metro Application

Klang Valley Mass Transit, Malaysia

Customer's need

- SRS Power Engineering Sdn Bhd building the test track for MRT2, looking for a complete traction power supply package.

ABB's response

- Design, supply and commissioning of a complete 750 VDC traction power supply package connecting to an existing MV grid.
 - Transformer-rectifier groups Enville TDR
 - DC switchgear Enville DCGear including protection and control
 - Automatic receptivity unit Enville ARU

Customer's benefits

- Electrification package with high-tech and high quality products and services, utilizing ABB's long standing experience in DC traction power supply applications.



DC Traction Power Supply

Metro Application

Warsaw Metro Line 2, Poland

Customer's need

- AGP Metro Polska building metro line 2 in the city of Warsaw looking for an energy efficient solution.

ABB's response

- Design, supply and commissioning of a complete DC traction power supply and distribution package.
 - Main low-voltage distribution MNS, medium voltage breakers VD4 and uninterruptible power supply
 - Transformer-rectifier groups Enviline TDR and DC switchgear Enviline DCGear
 - Energy storage system Enviline ESS

Customer's benefits

- Complete electrification package out of one hand.
- Average energy savings of more than 3 MWh per day.



DC Traction Power Supply

Mainline Railway Application

RFI Forli, Italy

Customer's need

- RFI looking at reinforcing its 3 kV DC network by using controlled rectifiers and static energy storage systems.

ABB's response

- Design, supply and commissioning of the following main equipment as replacement in a DC traction substation.
 - Energy storage Enviline ESS rated at 3000 VDC, 40 MJ storage capacity
 - IGBT based active rectifier Enviline ERS rated at 5 MW each
 - Testing and commissioning together with RFI

Customer's benefits

- The expertise of ABB in power conversion and traction power supply for a sophisticated storage and voltage support system.
- Voltage stabilization in the 3 kV DC grid.



DC Traction Power Supply

Mainline Railway Application

Polish Railway PKP, Poland

Customer's need

- PKP is undergoing a major refit program of nearly one hundred facilities related to power supply of the 3 kV traction power supply network.
- It is the most important upgrade investment project performed by Polish Railway PKP.

ABB's response

- Design, supply and commissioning of:
 - Transformer-rectifier groups Enviline TDR rated at 4 MVA
 - 3 kV DC switchgear Enviline DCGear/RPS

Customer's benefits

- Long standing expertise of ABB in 3 kV DC market.
- Comprehensive DC package form one vendor.



DC Traction Power Supply

Energy Storage Application

SEPTA Philadelphia, USA

Customer's need

- Southeastern Pennsylvania Transit Authority (SEPTA) undertaking a major project to capture regenerative braking energy looking for a technology provider of energy management systems.

ABB's response

- Design, supply and commissioning of:
 - Nine Enviline ESS for 10.3 MW, 750 VDC, 4.5 MWh battery capacity
 - Power control and monitoring system connecting to Viridity, Saft and SEPTA site equipment
 - Integration, testing and commissioning of the complete system

Customer's benefits

- The expertise of ABB in power conversion and traction power supply ensured on time project delivery.



DC Traction Power Supply

Energy Storage Application

Metro Trains Melbourne, Australia

Customer's need

- Metro Trains Melbourne (MTM) planning to introduce active voltage support in their 1500 VDC network.

ABB's response

- Design, supply and commissioning of:
 - One Enviline ESS rated at 1500 VDC, 40 MJ storage capacity
 - Integration, testing and commissioning of the complete system

Customer's benefits

- The expertise of ABB in power conversion and traction power supply for a sophisticated storage system.
- Voltage stabilization at a weak point of the 1500 V grid.



DC Traction Power Supply

Mining Application

Boliden AB's Aitik Mine, Sweden

Customer's need

- Swedish mining company Boliden looking for a groundbreaking power infrastructure for electric mine trucks.

ABB's response

- Design, supply and commissioning of an effective electrical infrastructure to power several mine trucks at Sweden's largest open-pit copper mine.
 - One digital substation connecting to the local medium voltage grid
 - Diode rectifier Enviline TDR rated at 4.8 MW feeding the line with 3 kV DC
 - ABB Ability™ 800xA control system

Customer's benefits

- The expertise of ABB in meeting the high demand in a sustainable manner by replacing parts of the mine's existing transport system with electric trucks.



Thank you for your attention

Useful links

Low voltage products and systems

<https://new.abb.com/low-voltage>

Medium voltage products and solutions

<https://new.abb.com/medium-voltage>

DC traction power supply

<https://new.abb.com/medium-voltage/switchgear/railway-switchgear/dc-traction-power-supply>



ABB