

Installation Instructions

1769-L32C, 1769-L35CR CompactLogix Controllers

Catalog Numbers 1769-L32C, 1769-L35CR

Topic	Page
Important User Information	3
Environment and Enclosure Information	4
Prevent Electrostatic Discharge	5
North American Hazardous Location Approval	7
Before You Begin	8
Set the Node Address	10
Connect the 1769-BA Battery	12
Install the Optional 1784-CF64 or 1784-CF128 Industrial CompactFlash Card	13
Assemble the System	15
Mount the System	19
Panel Mounting	20
DIN-rail Mounting	21
Product Dimensions	22
Connect a Programming Terminal to the Controller Via RS-232 Connections	23
Make ControlNet Connections to the Controller	26
Default Serial Configuration	25
Using the Channel 0 Default Communication Push Button	25

2 1769-L32C, 1769-L35CR CompactLogix Controller

Topic	Page
Install the Appropriate Electronic Data Sheet (EDS) Files	32
Load the Controller Firmware	33
Use the ControlFlash Utility to Load Firmware	35
Use the AutoFlash Utility to Load Firmware	35
Use a CompactFlash Card to Load Firmware	36
Select the Controller Operating Mode	37
Verify Proper Controller Operation	38
Interpret Status Indicators as Related to the ControlNet Network	41
Network Channel Status Indicators	43
Specifications	44
Additional Resources	48

Important User Information

Solid state equipment has operational characteristics differing from those of electromechanical equipment. Safety Guidelines for the Application, Installation and Maintenance of Solid State Controls (Publication SGI-1.1 available from your local Rockwell Automation sales office or online at <http://literature.rockwellautomation.com>) describes some important differences between solid state equipment and hard-wired electromechanical devices. Because of this difference, and also because of the wide variety of uses for solid state equipment, all persons responsible for applying this equipment must satisfy themselves that each intended application of this equipment is acceptable.





In no event will Rockwell Automation, Inc. be responsible or liable for indirect or consequential damages resulting from the use or application of this equipment.

The examples and diagrams in this manual are included solely for illustrative purposes. Because of the many variables and requirements associated with any particular installation, Rockwell Automation, Inc. cannot assume responsibility or liability for actual use based on the examples and diagrams.

No patent liability is assumed by Rockwell Automation, Inc. with respect to use of information, circuits, equipment, or software described in this manual.

Reproduction of the contents of this manual, in whole or in part, without written permission of Rockwell Automation, Inc., is prohibited.

Throughout this manual, when necessary, we use notes to make you aware of safety considerations.

<p>WARNING</p> 	<p>Identifies information about practices or circumstances that can cause an explosion in a hazardous environment, which may lead to personal injury or death, property damage, or economic loss.</p>
<p>IMPORTANT</p>	<p>Identifies information that is critical for successful application and understanding of the product.</p>
<p>ATTENTION</p> 	<p>Identifies information about practices or circumstances that can lead to personal injury or death, property damage, or economic loss. Attentions help you identify a hazard, avoid a hazard and recognize the consequences.</p>
<p>SHOCK HAZARD</p> 	<p>Labels may be on or inside the equipment (for example, drive or motor) to alert people that dangerous voltage may be present.</p>
<p>BURN HAZARD</p> 	<p>Labels may be on or inside the equipment (for example, drive or motor) to alert people that surfaces may reach dangerous temperatures.</p>

Environment and Enclosure Information

ATTENTION



This equipment is intended for use in a Pollution Degree 2 industrial environment, in overvoltage Category II applications (as defined in IEC publication 60664-1), at altitudes up to 2000 meters (6562 feet) without derating.

This equipment is considered Group 1, Class A industrial equipment according to IEC/CISPR Publication 11. Without appropriate precautions, there may be potential difficulties ensuring electromagnetic compatibility in other environments due to conducted as well as radiated disturbance.

This equipment is supplied as open-type equipment. It must be mounted within an enclosure that is suitably designed for those specific environmental conditions that will be present and appropriately designed to prevent personal injury resulting from accessibility to live parts. The enclosure must have suitable flame-retardant properties to prevent or minimize the spread of flame, complying with a flame spread rating of 5VA, V2, V1, V0 (or equivalent) if non-metallic. The interior of the enclosure must be accessible only by the use of a tool. Subsequent sections of this publication may contain additional information regarding specific enclosure type ratings that are required to comply with certain product safety certifications.

In addition to this publication, see:

- Industrial Automation Wiring and Grounding Guidelines, publication 1770-4.1, for additional installation requirements.
 - NEMA Standards publication 250 and IEC publication 60529, as applicable, for explanations of the degrees of protection provided by different types of enclosure.
-

Prevent Electrostatic Discharge

ATTENTION

This equipment is sensitive to electrostatic discharge, which can cause internal damage and affect normal operation. Follow these guidelines when you handle this equipment:

- Touch a grounded object to discharge potential static.
 - Wear an approved grounding wriststrap.
 - Do not touch connectors or pins on component boards.
 - Do not touch circuit components inside the equipment.
 - Use a static-safe workstation, if available.
 - Store the equipment in appropriate static-safe packaging when not in use.
-

ATTENTION

This product is grounded through the DIN rail to chassis ground. Use zinc plated yellow-chromate steel DIN rail to assure proper grounding. The use of other DIN rail materials (for example, aluminum or plastic) that can corrode, oxidize, or are poor conductors, can result in improper or intermittent grounding. Secure DIN rail to mounting surface approximately every 200 mm (7.8 in.) and use end-anchors appropriately.

WARNING

If you insert or remove the module while backplane power is on, an electrical arc can occur. This could cause an explosion in hazardous location installations.

Be sure that power is removed or the area is nonhazardous before proceeding.

WARNING

When you connect or disconnect the battery an electrical arc can occur. This could cause an explosion in hazardous location installations. Be sure that the area is nonhazardous before proceeding.

For Safety information on the handling of lithium batteries, including handling and disposal of leaking batteries, see Guidelines for Handling Lithium Batteries, publication AG 5-4.

WARNING

If you connect or disconnect the serial cable with power applied to this module or the serial device on the other end of the cable, an electrical arc can occur. This could cause an explosion in hazardous location installations.

Be sure that power is removed or the area is nonhazardous before proceeding.

WARNING

If you connect or disconnect the communications cable with power applied to this module or any device on the network, an electrical arc can occur. This could cause an explosion in hazardous location installations.

Be sure that power is removed or the area is nonhazardous before proceeding.

WARNING

When you insert or remove the CompactFlash Card while power is on, an electrical arc can occur. This could cause an explosion in hazardous location installations.



Be sure that power is removed or the area is nonhazardous before proceeding.

WARNING

The NAP port is intended for temporary local programming purposes only and not intended for permanent connection. If you connect or disconnect the NAP cable with power applied to this module or any device on the network, an electrical arc can occur. This could cause an explosion in hazardous location installations.

Be sure that power is removed or the area is nonhazardous before proceeding.

North American Hazardous Location Approval

<p>The following information applies when operating this equipment in hazardous locations.</p>	<p>Informations sur l'utilisation de cet équipement en environnements dangereux.</p>
<p>Products marked "CL I, DIV 2, GP A, B, C, D" are suitable for use in Class I Division 2 Groups A, B, C, D, Hazardous Locations and nonhazardous locations only. Each product is supplied with markings on the rating nameplate indicating the hazardous location temperature code. When combining products within a system, the most adverse temperature code (lowest "T" number) may be used to help determine the overall temperature code of the system. Combinations of equipment in your system are subject to investigation by the local Authority Having Jurisdiction at the time of installation.</p>	<p>Les produits marqués "CL I, DIV 2, GP A, B, C, D" ne conviennent qu'à une utilisation en environnements de Classe I Division 2 Groupes A, B, C, D dangereux et non dangereux. Chaque produit est livré avec des marquages sur sa plaque d'identification qui indiquent le code de température pour les environnements dangereux. Lorsque plusieurs produits sont combinés dans un système, le code de température le plus défavorable (code de température le plus faible) peut être utilisé pour déterminer le code de température global du système. Les combinaisons d'équipements dans le système sont sujettes à inspection par les autorités locales qualifiées au moment de l'installation.</p>
<p>WARNING</p> 	<p>EXPLOSION HAZARD -</p> <ul style="list-style-type: none"> • Do not disconnect equipment unless power has been removed or the area is known to be nonhazardous. • Do not disconnect connections to this equipment unless power has been removed or the area is known to be nonhazardous. Secure any external connections that mate to this equipment by using screws, sliding latches, threaded connectors, or other means provided with this product. • Substitution of components may impair suitability for Class I, Division 2. • If this product contains batteries, they must only be changed in an area known to be nonhazardous.
<p>AVERTISSEMENT</p> 	<p>RISQUE D'EXPLOSION –</p> <ul style="list-style-type: none"> • Couper le courant ou s'assurer que l'environnement est classé non dangereux avant de débrancher l'équipement. • Couper le courant ou s'assurer que l'environnement est classé non dangereux avant de débrancher les connecteurs. Fixer tous les connecteurs externes reliés à cet équipement à l'aide de vis, loquets coulissants, connecteurs filetés ou autres moyens fournis avec ce produit. • La substitution de composants peut rendre cet équipement inadapté à une utilisation en environnement de Classe I, Division 2. • S'assurer que l'environnement est classé non dangereux avant de changer les piles.

Before You Begin



Use this document as a guide for installing and powering-up your 1769-L32C or 1769-L35CR CompactLogix controller. You should already be familiar with the system components.

You must flash upgrade the firmware on your CompactLogix controller before you can use it. The controller ships with firmware revision 1.x but must be upgraded to match the version of RSLogix5000 software that you are using. For example, if you are using RSLogix5000 software, version 13, you must upgrade your CompactLogix controller firmware to revision 13.x before using it.

Be sure you have all components, noting the table that shows the components that ship with the controller.

IMPORTANT

The 1769-BA battery is the only battery you can use with the CompactLogix controller.

Component	Description
	1769-BA battery
	1747-KY controller key

You can also use these components with the controller:

- 1784-CF64 or 1784-CF128 Industrial CompactFlash card to add nonvolatile memory
- 1756-CP3 or 1747-CP3 serial cable to connect a device to the RS-232 port
- Either of the following to connect to the ControlNet network:
 - ControlNet taps for connections from controller channels A or B to the ControlNet network
 - 1786-CP cable for connections from a programming terminal to the ControlNet network via the controller's network access port (NAP)

Consider the following when planning your CompactLogix system:

- The CompactLogix controller is always the leftmost module in the system.
- The CompactLogix controller must be located within four modules of the power supply.
- Some I/O modules can be located up to eight modules away from the power supply; see the documentation for your 1769 I/O modules for details.
- The 1769-L32C controller supports as many as 16 I/O modules in a maximum of 3 I/O banks with 2 expansion cables.
- The 1769-L35CR controller supports as many as 30 I/O modules in a maximum of 3 I/O banks with 2 expansion cables.
- Each I/O bank requires its own power supply.
- Only one controller can be used in a CompactLogix system.

10 1769-L32C, 1769-L35CR CompactLogix Controller

- A 1769-ECR right end cap or 1769-ECL left end cap is required to terminate the end of the communication bus.

ATTENTION



This controller has a network access port (NAP) for temporary connections to the ControlNet network. Do not plug a DH-485 network cable or an RJ45 connector for EtherNet/IP networks into the NAP. Undesirable behavior and/or damage to the port may result.

Set the Node Address

Every ControlNet network requires at least one module that can store parameters and configure the network with those parameters upon startup. The CompactLogix controller is called a keeper because it keeps the network configuration.

The CompactLogix controller can keep the network parameters at any legal node address (01...99). Multiple devices on any one network can act as the network keepers. Each device capable of being the network keeper acts to back up the current keeper. This back-up function is automatic and requires no action on your part.

Node address switches are set to the 99 position at shipment, as shown in the figure.

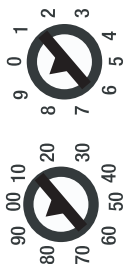

43868

Use these steps to set the node address.

1. Slide the side cover forward.

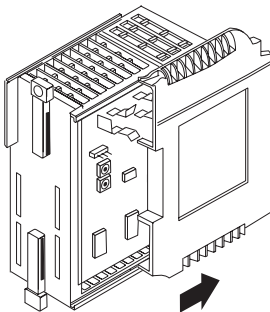

43860

2. Use a small screwdriver to set the node address via the controller switches.

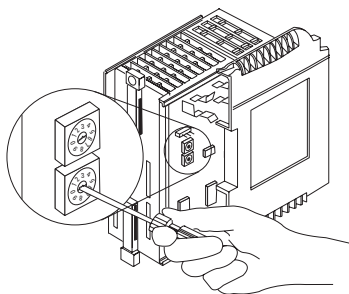

31504-M

3. Write the node address on the front panel overlay after setting the node address switches.

Connect the 1769-BA Battery

The controller is shipped with the 1769-BA battery packed separately. To connect the battery, follow this procedure.

ATTENTION

The 1769-BA battery is the only battery you can use with the 1769-L32C and 1769-L35CR controllers. The 1747-BA battery is not compatible with the 1769-L32C and 1769-L35CR controllers and may cause problems.

WARNING

When you connect or disconnect the battery, an electrical arc can occur. This could cause an explosion in hazardous location installations. Be sure that power is removed or the area is nonhazardous before proceeding. For safety information on the handling of lithium batteries, including handling and disposal of leaking batteries, see Guidelines for Handling Lithium Batteries Technical Data, publication AG-5.4.

1. Remove the battery door by sliding it forward.

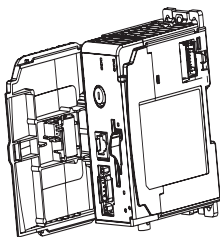

IMPORTANT

Do not remove the plastic insulation covering the battery. The insulation is necessary to protect the battery contacts.

2. Insert the battery connector into the black receptacle on the board.
The connector is keyed to be installed with the correct polarity.

3. Insert the battery into the door as shown.

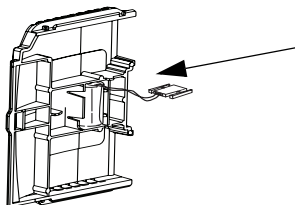

4. Slide the battery door back until it clicks into position.

Install the Optional 1784-CF64 or 1784-CF128 Industrial CompactFlash Card

ATTENTION

Do not remove the CompactFlash card while the controller is reading from or writing to the card, as indicated by a flashing green CF status indicator. This could corrupt the data on the card or in the controller, as well as corrupt the latest firmware in the controller.

A 1784-CF64 Industrial CompactFlash card provides nonvolatile memory for a CompactLogix controller. This is an optional feature and is not required to operate the controller. Install the card as follows.

1. Push the locking tab to the right.
2. Insert the 1784-CF64 Industrial CompactFlash card into the socket on the front of the controller, noting the label of the CompactFlash card faces towards the left.

3. Match the orientation arrow on the card with the arrow on the front of the controller.

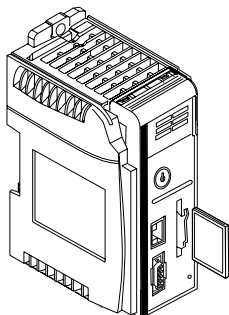

4. Note that the CompactFlash card supports removal and insertion under power.

WARNING



When you insert or remove the CompactFlash Card while power is on, an electrical arc can occur. This could cause an explosion in hazardous location installations.

Be sure that power is removed or the area is nonhazardous before proceeding.

5. To remove the CompactFlash card, push the locking tab away from the CompactFlash card and pull the CompactFlash card from the socket.

Assemble the System

The controller can be attached to an adjacent I/O module or power supply before or after mounting. For mounting instructions, see Panel Mounting and DIN-rail Mounting.

WARNING

The CompactLogix controller is not designed for removal and insertion under power.

If you insert or remove the module while backplane power is on, an electrical arc can occur. This could cause an explosion in hazardous location installations.

Be sure that power is removed or the area is nonhazardous before proceeding.

1. Disconnect line power.
2. Make sure the lever of the adjacent module is in the unlocked (fully right) position.

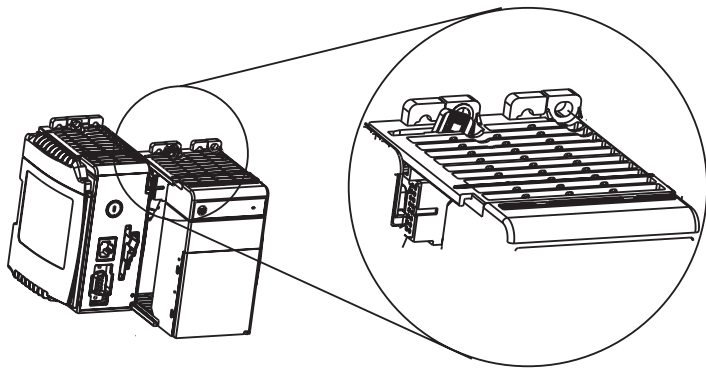

3. Use the upper and lower tongue-and-groove slots to secure the modules together.

4. Move the module back along the tongue-and-groove slots until the bus connectors line up with each other.

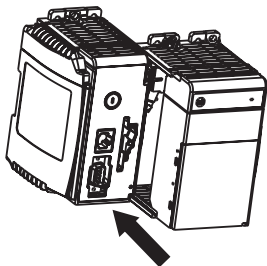

5. Use your fingers or a small screwdriver to push the module's bus lever back slightly to clear the positioning tab.

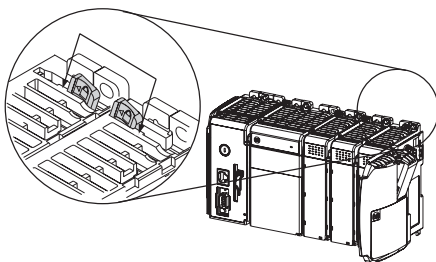

6. Move the module's bus lever fully to the left until it clicks, making sure the bus lever is fully engaged and locked.

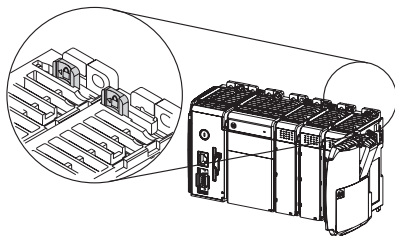
**ATTENTION**

When attaching the controller, power supply, and I/O modules, make sure the bus connectors are securely locked together to be sure of proper electrical connection.

7. Use the tongue-and-groove slots (described in steps 2 and 3) to attach an end cap terminator to the last module in the system.

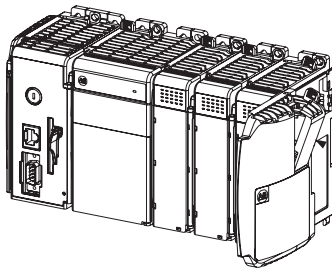

8. Move the end cap terminator back along the tongue-and-groove slots until the bus connectors line up with each other.
9. Lock the end cap bus terminator.

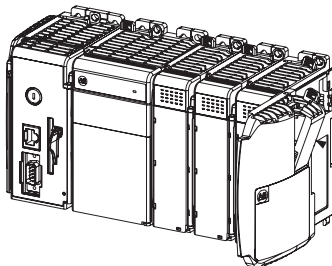

Mount the System

ATTENTION



During panel or DIN rail mounting of all devices, be sure that all debris (such as metal chips or wire strands) is kept from falling into the controller. Debris that falls into the controller could cause damage while the controller is energized.

ATTENTION



When attaching the controller, power supply, and I/O modules, make sure the bus connectors are securely locked together to be sure of proper electrical connection.

IMPORTANT

When mounting the CompactLogix system, either use screws to panel mount system or use DIN rail. Do **not** use both. Use of both mounting methods may cause hardware damage and cause the system to fail.

Maintain spacing from items such as enclosure walls, wireways, and adjacent equipment. Allow 50 mm (2 in.) of space on all sides, as shown. This provides ventilation and electrical isolation.

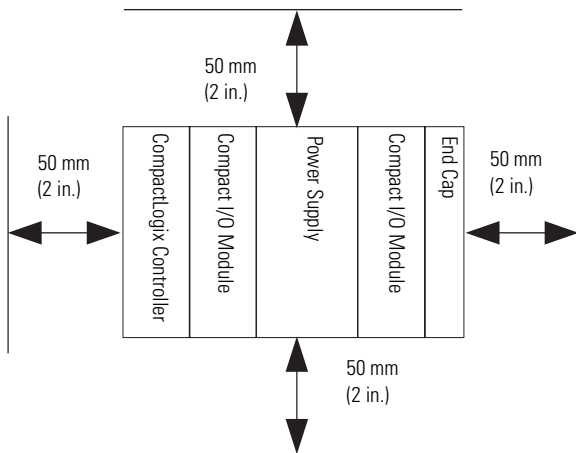

Panel Mounting

Mount the controller to a panel by using two screws per module. Use M4 or #8 panhead screws. Mounting screws are required on every module.

IMPORTANT

The grounding tab, located where you install the mounting screws, enables the module to be grounded when it is panel-mounted.

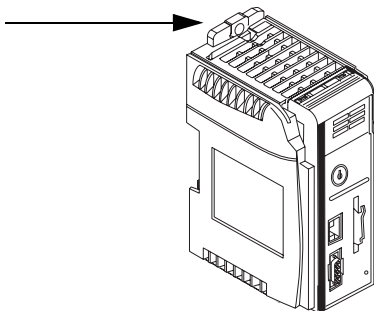

This procedure lets you use the assembled modules as a template for drilling holes in the panel. Due to module mounting-hole tolerance, it is important to follow these procedures.

1. On a clean work surface, assemble no more than three modules.
2. Using the assembled modules as a template, carefully mark the center of all module-mounting holes on the panel.
3. Return the assembled modules to the clean work surface, including any previously mounted modules.
4. Drill and tap the mounting holes for the recommended M4 or #8 screw.
5. Place the modules back on the panel and check for proper hole alignment.

-
6. Attach the modules to the panel by using the mounting screws.

IMPORTANT

If mounting more modules, mount only the last one of this group and put the others aside. This reduces remounting time when you are drilling and tapping the next group of modules.

7. Repeat steps 1...6 for any remaining modules.

DIN-rail Mounting

The controller can be mounted by using the following DIN rails:

- EN 50 022 - 35 x 7.5 mm (1.38 x 0.30 in.)
- EN 50 022 - 35 x 15 mm (1.38 x 0.59 in.)

Before mounting the controller on a DIN rail, close the DIN rail latches. Press the DIN rail mounting area of the controller against the DIN rail. The latches will momentarily open and lock into place.

ATTENTION

This product is grounded through the DIN rail to chassis ground. Use zinc plated yellow-chromate steel DIN rail to assure proper grounding. The use of other DIN rail materials (for example, aluminum and plastic) that can corrode, oxidize, or are poor conductors, can result in improper or intermittent grounding. Secure DIN rail to mounting surface approximately every 200 mm (7.8 in.) and use end-anchors appropriately.

This product is intended to be mounted to a well-grounded mounting surface, such as a metal panel. Additional grounding connections from the controller's grounding tab or DIN rail (if used) are not required unless the mounting surface cannot be grounded.

Refer to Industrial Automation Wiring and Grounding Guidelines, Allen-Bradley publication 1770-4.1, for additional information.

Product Dimensions

The figure shows dimensions in mm (in.). Hole spacing tolerance is ± 4 mm (0.016 in.).

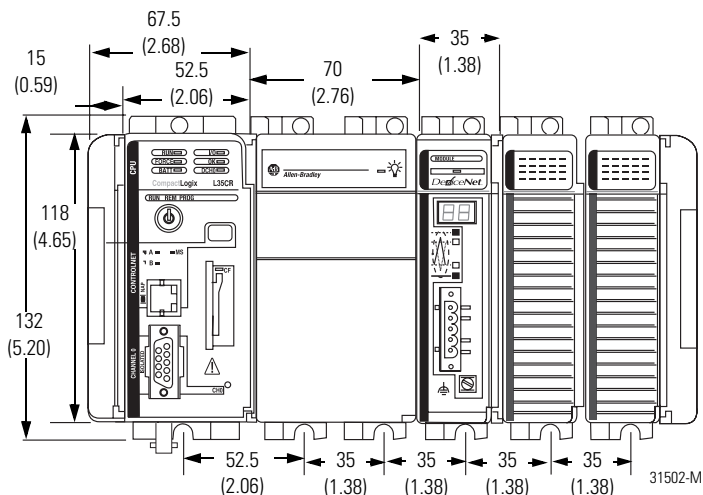

IMPORTANT

Compact I/O expansion cables have the same dimensions as the end caps. Expansion cables can be used on either the right or left end.

A 1769-ECR right end cap or 1769-ECL left end cap terminates the end of the communication bus.

Connect a Programming Terminal to the Controller Via RS-232 Connections

Use an RS-232 cable to connect your CompactLogix controller to your programming terminal. You can use either of the following RS-232 cables:

- 1747-CP3
- 1756-CP3

WARNING



If you connect or disconnect the serial cable with power applied to this module or the serial device on the other end of the cable, an electrical arc can occur. This could cause an explosion in hazardous location installations.

Be sure that power is removed or the area is nonhazardous before proceeding.

The figure shows the RS-232 cable connections. The 1747-CP3 or 1756-CP3 cable must be shielded and tied to the connector housing.

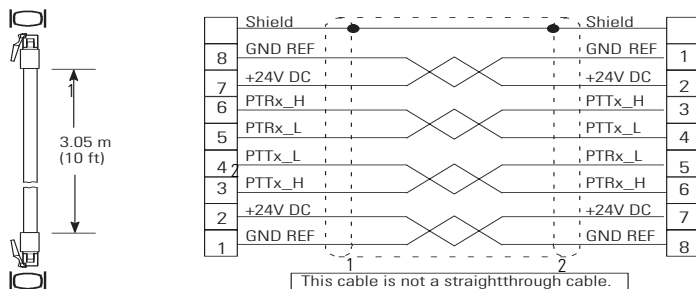

Item	Description
1	9-pin, male D-shell straight cable end
2	9-pin, female D-shell right-angle cable end

1. Connect the 9-pin, right-angle connector of the RS-232 cable to the serial port on your CompactLogix controller.

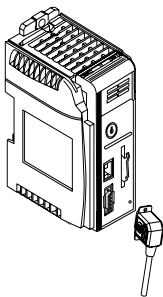

2. Connect the 9-pin, straight connector of the RS-232 cable to your programming terminal.



Default Serial Configuration

Channel 0 (serial) has the following default communication configuration.

Channel 0 Serial Default Communication Configuration

Parameter	Default
Protocol	DF1 full-duplex
Baud Rate	19.2 Kbit/s
Parity	None
Station Address	0
Control Lines	No handshaking
Error Detection	BCC
Embedded Responses	Auto detect
Duplicate Packet (Message) Detect	Enabled
ACK Timeout	50 (x 20 ms)
NAK Receive Limit	3 retries
ENQ Transmit Limit	3 retries
Data Bits	8
Stop Bits	1

Using the Channel 0 Default Communication Push Button

The channel 0 default communication pushbutton is on the front of the controller in the lower right corner as shown in the figure.

Use the pushbutton to change from the user-defined communication configuration to the Default Communications mode.

The Channel 0 Default Communications (DCH0) status indicator turns on (green, steady) to show when the default communication configuration is active.

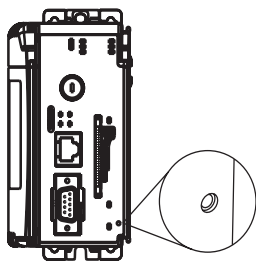

IMPORTANT

Before pressing the default communication pushbutton, be sure to note the present communication configuration for Channel 0.

Pushing the default communication pushbutton resets all configured parameters back to their default settings.

To return the channel to its user-configured parameters, you must enter them manually while online with the controller or download them as part of an RSLogix 5000 project file. To accomplish this online by using RSLogix 5000 software, enter the Controller Properties dialog box and use the Serial Port, System Protocol, and User Protocol tabs.

Make ControlNet Connections to the Controller

The CompactLogix 1769-L32C and 1769-L35CR controllers connect to the ControlNet network. The CompactLogix 1769-L32C controller supports channel A connections only. The CompactLogix 1769-L35CR controller supports channels A and B (redundant media) connections.

For permanent connections to the network, you connect the module to the ControlNet network by using a ControlNet tap (for example, 1786-TPR, 1786-TPS, 1786-TPYR, 1786-TPYS).

The figure shows an example ControlNet network using redundant media.

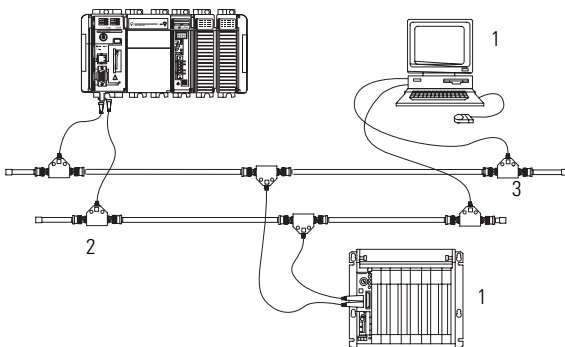

Item	Description
1	ControlNet node
2	Redundant media available on 1769-L35CR only
3	ControlNet link

When connecting the CompactLogix controller to a ControlNet network, also refer to the following documentation:

- ControlNet Coax Tap Installation Instructions, publication 1786-IN007
- ControlNet Cable System Planning and Installation Manual, publication 1786-6.2.1

IMPORTANT

For network connections we recommend taps with a straight connector (catalog number 1786-TPS or 1786-TPYS) because of the location of the BNC connectors on the bottom of the module.

Connect the Controller to the Network Via a ControlNet Tap

Typically, ControlNet taps are used to make permanent connections from the CompactLogix controller to the network. Perform the following steps to connect the module to the network by using a ControlNet tap.

ATTENTION

Do not allow any metal portions of the tap to contact any conductive material.



If you disconnect the tap from the module, place the dust cap back on the straight or right angle connector to prevent the connector from accidentally contacting a metallic grounded surface.

1. Remove and save the dust caps from the ControlNet taps.

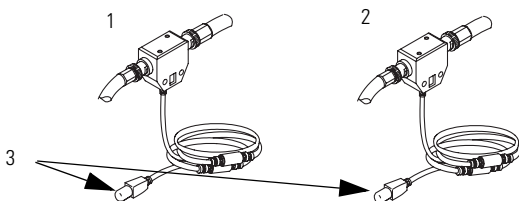

Item	Description
1	Segment 1
2	Segment 2
3	Dust caps

- Connect the tap's straight or right-angle connector to the module's BNC connector as shown in the figure.

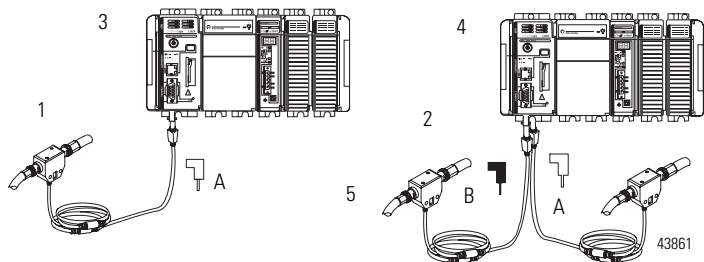

Item	Description
1	Segment 1
2	Segment 2
3	Tap connected to a CompactLogix controller not using redundant media
4	Tap connected to a CompactLogix controller using redundant media (1769-L35CR unit only)
5	Tap

IMPORTANT

To prevent inadvertent reversal of the tap connections (resulting in incorrect status displays requiring troubleshooting), check the tap drop cable for the label indicating the attached segment before making your connection.

WARNING

If you connect or disconnect the communication cable with power applied to this module or any device on the network, an electrical arc can occur. This could cause an explosion in hazardous location installations.

Be sure that power is removed or the area is nonhazardous before proceeding.

Connect a Programming Terminal to the Network Via a 1786-CP Cable

You can use the CompactLogix controller's network access port (NAP) to connect a programming terminal to the ControlNet network. The figure shows the 1786-CP cable connections.

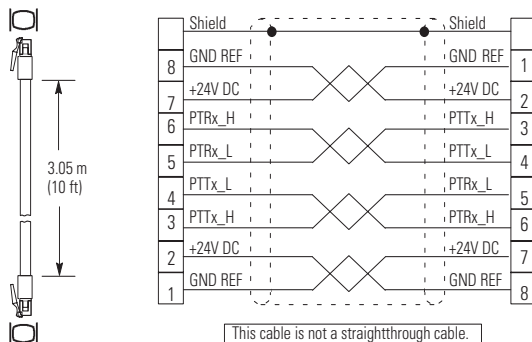

WARNING



The NAP port is intended for temporary local-programming purposes only and not intended for permanent connection. If you connect or disconnect the NAP cable with power applied to this module or any device on the network, an electrical arc can occur. This could cause an explosion in hazardous location installations.

Be sure that power is removed or the area is nonhazardous before proceeding.

ATTENTION



Use the 1786-CP cable when you connect a programming terminal to the network through the NAP.

Using another cable could result in possible network failures or product damage.

Connect one end of the 1786-CP cable to the CompactLogix controller and the other end to the NAP of the programming terminal.

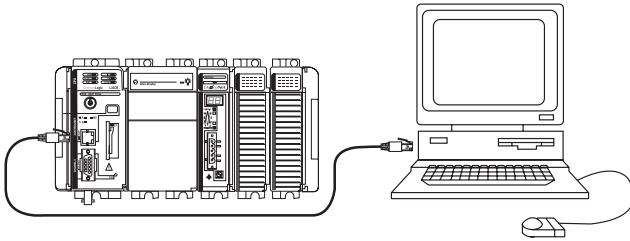
**ATTENTION**

Do not plug a DH-485 network cable or an RJ45 connector for the EtherNet/IP network to the NAP. Undesirable behavior and/or damage to the port may result.

Install the Appropriate Electronic Data Sheet (EDS) Files

If you have RSLinx software, version 2.43 or greater, the most current EDS files were installed with the software. If you are using RSLinx software, version 2.42 or later, you might need to install EDS files. You need EDS files for the following:

- 1769-L32C controller
- 1769-L32C ControlNet port
- 1769-L35CR controller
- 1769-L35CR ControlNet port
- 1769 CompactBus
- 1769 local adapter

All of these EDS files, except for the 1769 CompactBus file, are updated for each firmware revision. There is also a revision 1.x of the EDS files that you need for new controllers. Each controller ships with revision 1.x firmware.

To update the firmware, you must have these revision 1.x EDS files installed:

- 0001000E00500100.eds for the controller
- 0001000C00A00100.eds for the ControlNet port

The EDS files are available on the CD for RSLogix 5000 Enterprise Series software, version 13. The files are also available at <http://www.ab.com/networks/eds>.

Load the Controller Firmware

The controller ships without working firmware. You must download the current firmware before you can use the controller. To load firmware, you can use:

- ControlFlash utility that ships with RSLogix5000 software.
- AutoFlash that starts through RSLogix5000 software when you try to download a project and the controller does not have the current firmware.
- 1784-CF64 CompactFlash card with valid memory already loaded.

The firmware is available with RSLogix 5000 software or you can download it from the support website by using these steps.

1. Go to <http://support.rockwellautomation.com>.
2. In the left column (frame), click Technical Support and Firmware Updates.
3. Select the firmware revision.

The download process requires you to enter the serial number of your RSLogix 5000 programming software.

If you load (flash) controller firmware via the ControlFlash or AutoFlash utilities, you need either a serial or ControlNet connection to the controller. Flashing via a ControlNet connection is faster than the serial connection.

Use the ControlFlash Utility to Load Firmware

You can use the ControlFlash utility to load firmware through either a ControlNet connection or a serial connection.

1. Make sure the appropriate network connection is made before starting.
2. Start the ControlFlash utility, clicking Next when the Welcome screen appears.
3. Select the catalog number of the controller and click Next.
4. Expand the network until you see the controller, noting that if the required network is not shown, you must first configure a driver for the network in RSLinx software.
5. Select the controller and click OK.
6. Select the revision level to which you want to update the controller and click Next.
7. To start the update of the controller, click Finish and Yes, noting that after the controller is updated, the status box displays Update complete.
8. Click OK.
9. Click Cancel and Yes to close ControlFlash software.

Use the AutoFlash Utility to Load Firmware

You can use the AutoFlash utility to load firmware through either a ControlNet connection or a serial connection.

1. Make sure the appropriate network connection is made before starting.
2. Use RSLogix 5000 programming software to attempt to download to a controller project.
This automatically launches AutoFlash.
3. Select the catalog number of the controller and click Next.
4. Expand the network until you see the controller, noting that if the required network is not shown, you must first configure a driver for the network in RSLinx software.
5. Select the controller and click OK.
6. Select the revision level to which you want to update the controller and click Next.
7. To start the update of the controller, click Finish and click Yes, noting that after the controller is updated, the status box displays Update complete.
8. Click OK.
9. Click Cancel and Yes to close AutoFlash software.

Use a CompactFlash Card to Load Firmware

If you have an existing controller that is already configured and has firmware loaded, you can store the current controller user program and firmware on the CompactFlash card and use that card to update other controllers.

1. Use RSLogix 5000 software to store the controller user program and firmware of a currently configured controller to the CompactFlash card.
2. Click the Nonvolatile Memory tab of the Controller Properties dialog, making sure to click Load Image On Powerup when you save to the card.
3. Remove the card and insert it into a controller that you want to have the same firmware and controller user program.

When you power up the second controller, the image stored on the CompactFlash card is loaded into the controller.

Select the Controller Operating Mode

Use the keyswitch on the front panel of the controller to determine the controller Operating mode.

Keyswitch	Description
RUN	<ul style="list-style-type: none"> • Upload projects. • Run the program and enable outputs. • You cannot create or delete tasks, programs, or routines. You cannot create or delete tags or edit online while the keyswitch is in the RUN position. • You cannot change the mode by using the programming software while the keyswitch is in the RUN position.
PROG	<ul style="list-style-type: none"> • Disable outputs. • Upload/download projects. • Create, modify, and delete tasks, programs, or routines. • The controller does not execute (scan) tasks while the keyswitch is in the PROG position. • You cannot change the mode through the programming software while the keyswitch is in the PROG position.
REM	<ul style="list-style-type: none"> • Upload/download projects. • Change between Remote Program, Remote Test, and Remote Run modes through the programming software.

Keyswitch	Description
REM - Remote Run	<ul style="list-style-type: none"> • The controller executes (scans) tasks. • Enable outputs. • Edit online.
REM - Remote Program	<ul style="list-style-type: none"> • Disable outputs. • Create, modify, and delete tasks, programs or routines. • Download projects. • Edit online. • The controller does not execute (scan) tasks.
REM - Remote Test	<ul style="list-style-type: none"> • Execute tasks with outputs disabled. • Edit online.

Verify Proper Controller Operation

To verify that your controller is operating properly, use the controller's various status indicators as shown in the tables.

Controller Status Indicators

Indicator	Status	Description
RUN	Off	The controller is in Program or Test mode.
	Steady green	The controller is in Run mode.
FORCE	Off	No tags contain I/O force values. I/O forces are inactive (disabled).
	Steady amber	I/O forces are active (enabled). I/O force values may or may not exist.
	Flashing amber	One or more input or output addresses have been forced to an On or Off state, but the forces have not been enabled.
BAT	Off	The battery supports memory.
	Steady red	Either the battery is: <ul style="list-style-type: none"> • not installed and should be installed. • 95% discharged and should be replaced.

Controller Status Indicators

Indicator	Status	Description
I/O	Off	Either of the following: <ul style="list-style-type: none"> • There are no devices in the I/O configuration of the controller. • The controller does not contain a project (controller memory is empty).
	Steady green	The controller is communicating with all the devices in its I/O configuration.
	Flashing green	One or more devices in the controller's I/O configuration are not responding.
	Flashing red	The controller is not communicating to any devices. The controller is faulted.
OK	Off	No power is applied.
	Flashing red	If a new controller, the controller requires a firmware update. If not a new controller, a major fault occurred. To clear the fault, either: <ul style="list-style-type: none"> • turn the keyswitch from PROG to RUN to PROG. • go online with RSLogix 5000 software.
	Steady red	Controller detected a nonrecoverable fault and cleared the project. Follow these steps to recover: <ol style="list-style-type: none"> 1. Cycle power to the chassis. 2. Download the project. 3. Change to Run mode. If the OK status indicator remains solid red, contact your Rockwell Automation representative or local distributor.
	Steady green	Controller is OK.
	Flashing green	The controller is storing or loading a project to or from nonvolatile memory.

RS-232 Serial Port Status Indicators (channel 0)

Indicator	Status	Description
DCH0	Off	Channel 0 is configured differently than the default serial configuration.
	Steady green	Channel 0 has the default serial configuration.
CH0	Off	No RS-232 activity.
	Flashing green	RS-232 activity.

CompactFlash Card Status Indicators

Indicator	Status	Description
CF	Off	No activity.
	Flashing green	The controller is reading from or writing to the CompactFlash card.
	Flashing red	CompactFlash card does not have a valid file system.

ATTENTION

Do not remove the CompactFlash card while the controller is reading from or writing to the card, as indicated by a flashing green CF status indicator. This could corrupt the data on the card or in the controller, as well as corrupt the latest firmware in the controller.

Interpret Status Indicators as Related to the ControlNet Network

Use the Module Status and Network Status indicators to determine how your CompactLogix controller is operating on the ControlNet network.

These status indicators provide information about the controller and the network when the controller is connected to the ControlNet network via the BNC connectors and describes the possible conditions for module and network status indicators.

Indicator Condition	Description
Steady	The indicator is on continuously in the defined state.
Alternating	Two indicators alternate between the two defined states at the same time (applies to both indicators when viewed together); the two indicators are always in opposite states, out of phase.
Flashing	The indicator alternates between the two defined states (applies to each indicator viewed independent of the other); if both indicators are flashing, they flash together, in phase.

IMPORTANT

Keep in mind that the Module Status indicator reflects the module state (for example, self-test, firmware update, normal operation but no connection established). The network status indicators, A and B, reflect network status. Remember that the host is able to engage in local messaging with the card although it is detached from the network. Therefore, the Module Status status indicator is flashing green if the host has successfully started the card. Note, however, that until the host removes reset, all status indicators on the daughtercard remain off.

When you view the indicators, always view the Module Status indicator first to determine the state of the daughtercard. This information may help you to interpret the Network Status indicators. As a general practice, view all status indicators (Module Status and Network Status) together to gain a full understanding of the daughtercard's status.

Module Status Indicator

Indicator	Status	Description
MS	Off	Controller has no power. Apply power.
		Make sure that the controller is firmly seated in the slot.
	Steady red	Major fault occurred on the controller. Cycle power. If problem persists, replace the controller.
	Flashing red	Minor fault occurred because a firmware update is in progress. No action required (firmware update in progress).
		Node address switch change occurred. The controller's node address switches may have been changed since power-up.
		Controller uses invalid firmware. Update the controller firmware with the ControlFlash Update utility.
		Controller's node address duplicates that of another device. Remove power. Change the node address to a unique setting. Reapply power.
	Steady green	Connections are established.
Flashing green	No connections are established. Establish connections, if necessary.	
Flashing red/green	The controller is performing self-diagnostics. Wait briefly to see if problem corrects itself. If problem persists, check the host. If the daughtercard cannot communicate with the host, the card can remain in Self-test mode.	

Network Channel Status Indicators

Only channel B is labeled on the 1769-L35CR controller. The 1769-L32C controller has only channel A but uses the second indicator in some status indicator patterns as described in the table.

 A □

 B □

Network Channel Status Indicators

Indicator	Status	Description
Both channel indicators	Off	A channel is disabled. Program network for redundant media, if necessary.
	Steady green	Normal operation is occurring.
	Flashing green/off	Temporary network errors have occurred. Check media for items such as broken cables, loose connectors, and missing terminators. If condition persists, refer to the ControlNet Planning and Installation Manual, publication 1786-6.2.1.
		The node is not configured to go online. Make sure the network keeper is present and working and the selected address is less or equal to the UMAX ⁽¹⁾ .
	Flashing red/off	Media fault has occurred. Check media for items such as broken cables, loose connectors, and missing terminators. If condition persists, refer to the ControlNet Planning and Installation Manual, publication 1786-6.2.1.
No other nodes present on the network. Add other nodes to the network.		
Flashing red/green	The network is configured incorrectly. Reconfigure the ControlNet network so that UMAX \geq the card's node address.	

Network Channel Status Indicators

Either channel indicator	Off	Check the MS indicators.
	Steady red	The controller is faulted. Cycle power. If the fault persists, contact your Rockwell Automation representative or distributor.
	Alternating red/green	Controller is performing a self-test.
	Alternating red/off	Node is configured incorrectly. Check the card's network address and other ControlNet configuration parameters.

⁽¹⁾ UMAX is the highest node address on a ControlNet network that can transmit data.

Specifications

CompactLogix Controller - 1769-L32C, 1769-L35CR

Attribute	Value	
Communication ports	1769-L32C RS-232, NAP, ControlNet channel A	1769-L35CR RS-232, NAP, ControlNet channels A and B
User memory	1769-L32C 750 KB	1769-L35CR 1.5 MB
Nonvolatile memory	1784-CF64 or 1784-CF128 CompactFlash	
Number of I/O modules, max	1769-L32C 16 I/O modules	1769-L35CR 30 I/O modules
Number of I/O banks, max	3 banks	
Backplane current ⁽¹⁾	1769-L32C 650 mA at 5V DC 40 mA at 24V DC	1769-L35CR 680 mA at 5V DC 40 mA at 24V DC
Power dissipation	1769-L32C 4.21 W	1769-L35CR 4.36 W
Power supply distance rating	4 (The controller must be within four slot positions of the power supply.)	

CompactLogix Controller - 1769-L32C, 1769-L35CR

Attribute	Value	
North American temp code	T4A	
Replacement battery	1769-BA	
Weight, approx.	0.32 kg (0.70 lb)	
Programming cable	1747-CP3 or 1756-CP3	
Panel mounting screw torque (using M4 or #8 screws)	1.1...1.18 N•m (10...16 lb•in)	
Wiring category	2 on communication ports ⁽²⁾	
Wiring connectors	1769-L32C 1 BNC connector 1 NAP (1786-CP cable)	1769-L35CR 2 BNC connectors for redundant media operation 1 NAP (1786-CP cable)
Isolation voltage (continuous-voltage withstand rating)	30V (continuous), Basic Insulation Type Type tested at 710V DC for 60 s, RS232 to system, CNet to system, RS232 to CNet, CNet Channel A to CNet channel B	
Enclosure Type Rating	None (open-style)	

⁽¹⁾ This specification is known as Power Consumption.

⁽²⁾ Use this Conductor Category information for planning conductor routing. See Industrial Automation Wiring and Grounding Guidelines, publication 1770-4.1.

Environmental Specifications

Attribute	Value
Operational temperature IEC 60068-2-1 (Test Ad, Operating Cold) IEC 60068-2-2 (Test Bd, Operating Dry Heat) IEC 60068-2-14 (Test Nb, Operating Thermal Shock)	0...60 °C (32...140 °F)
Storage temperature IEC 60068-2-1 (Test Ab, Unpackaged Nonoperating Cold) IEC 60068-2-2 (Test Bb, Unpackaged Nonoperating Dry Heat) IEC 60068-2-14 (Test Na, Unpackaged Thermal Shock)	-40... +85 °C (-40...185 °F)
Relative humidity IEC 60068-2-30 (Test Db, Unpackaged)	5...95% noncondensing
Vibration IEC 60068-2-6 (Test Fc, Operating)	5 g @ 10...500 Hz
Shock IEC 60068-2-27 (Test Ea, Unpackaged Shock) DIN rail mount Panel mount	Operating: 20 g; Nonoperating: 30 g Operating: 30 g; Nonoperating: 40 g
Emissions - CISPR 11	Group 1, Class A
ESD immunity - IEC61000-4-2	6 kV contact discharges, 8 kV air discharges
EFT/B immunity - IEC 61000-4-4	±2 kV at 5 kHz on communication ports

Environmental Specifications

Attribute	Value
Surge transient immunity IEC61000-4-5	±2 kV line-earth (CM) on communication ports
Conducted RF immunity IEC61000-4-6	10V rms with 1kHz sine-wave 80% AM from 150 kHz...80 MHz
Radiated RF immunity IEC61000-4-3	10V/m with 1 kHz sine-wave 80%AM from 80...2000 MHz 10/m with 200 Hz 50% Pulse 100%AM at 900 MHz 10V/m with 200 Hz 50% Pulse 100%AM at 1890 MHz

Certifications

Certifications⁽¹⁾ (when product is marked)	Value
c-UL-us	UL Listed Industrial Control Equipment, certified for US and Canada. See UL File E65584. UL Listed for Class I, Division 2 Group A,B,C,D Hazardous Locations, certified for U.S. and Canada. See UL File E194810.
CE	European Union 2004/108/EC EMC Directive, compliant with: EN 61326-1; Meas./Control/Lab., Industrial Requirements EN 61000-6-2; Industrial Immunity EN 61000-6-4; Industrial Emissions EN 61131-2; Programmable Controllers (Clause 8, Zone A & B)
C-Tick	Australian Radio Communications Act, compliant with: AS/NZS CISPR 11; Industrial Emissions
CI	ControlNet Int'l conformance tested to ControlNet specifications

⁽¹⁾ See the Product Certification link at <http://www.ab.com> for Declarations of Conformity, Certificates, and other certification details.

Additional Resources

These documents contain additional information concerning related Rockwell Automation <http://www.ab.com> products.

Resource	Description
CompactLogix System User Manual, publication 1769-UM011	Provides information about planning, mounting, wiring, and troubleshooting your CompactLogix system.
ControlNet Modules in Logix5000 Control Systems User Manual, publication CNET-UM001	Provides information about how to use ControlNet Modules in Logix5000 control systems.
Logix5000 Controllers Common Procedures, publication 1756-PM001, publication 1756-PM001	Describes developing projects for Logix5000 controllers.
Logix5000 Controllers General Instructions Reference Manual, publication 1756-RM003	Provides information about programming the controller for sequential applications.
Logix5000 Controllers Process Control and Drives Instructions Reference Manual, publication 1756-RM006	Provides a reference manual for Logix5000 process control and drives.
Product Certifications website, http://www.ab.com	Provides declarations of conformity, certificates, and other certification details.

You can view or download publications at <http://literature.rockwellautomation.com>. To order paper copies of technical documentation, contact your local Rockwell Automation distributor or sales representative.

Allen-Bradley, ControlFlash, Compact I/O, CompactLogix, Logix5000, RSLinx, RSLogix 5000, Rockwell Automation, and TechConnect are trademarks of Rockwell Automation, Inc. Trademarks not belonging to Rockwell Automation are property of their respective companies.

www.rockwellautomation.com

Power, Control and Information Solutions Headquarters

Americas: Rockwell Automation, 1201 South Second Street, Milwaukee, WI 53204-2498 USA, Tel: (1) 414-382-2000, Fax: (1) 414-382-4444

Europe/Middle East/Africa: Rockwell Automation, Vorstaan/Boulevard du Souverain 36, 1170 Brussels, Belgium, Tel: (32) 2 665 0600, Fax: (32) 2 665 0640

Publication 1769-IN070C-EN-P - May 2008

PN 953157-29

Supersedes Publication 1769-IN070B-EN-P - December 2004

Copyright © 2008 Rockwell Automation, Inc. All rights reserved. Printed in the U.S.A.